

FAX-8360P

OWNER'S MANUAL

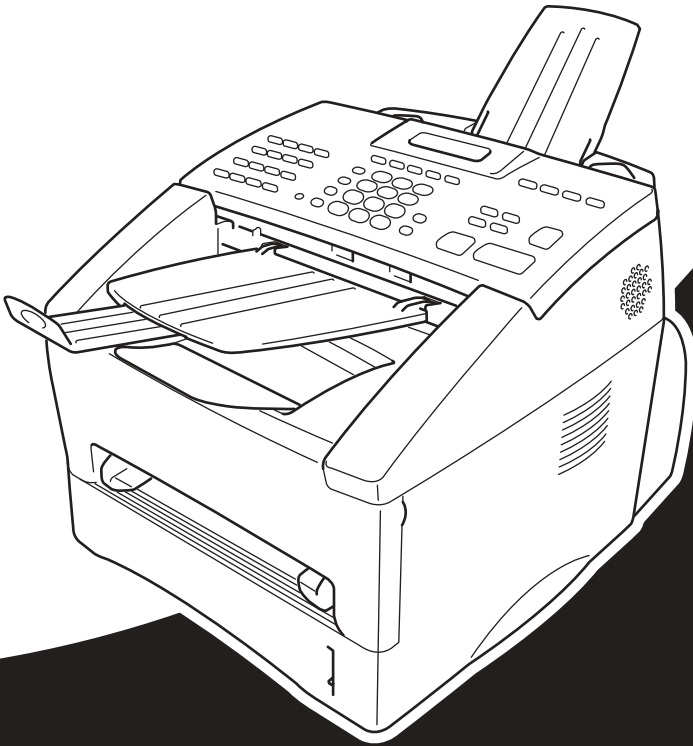

CE

At your side.
brother®

Version B

THIS EQUIPMENT IS DESIGNED TO WORK WITH A TWO WIRE ANALOGUE PSTN LINE FITTED WITH THE APPROPRIATE CONNECTOR.

APPROVAL INFORMATION

Brother advises that this product may not function correctly in a country other than where it was originally purchased, and does not offer any warranty in the event that this product is used on public telecommunication lines in another country.



EC Declaration of Conformity under the R & TTE Directive

Manufacturer

Brother Industries Ltd.,
15-1, Naeshiro-cho, Mizuho-ku,
Nagoya 467-8561, Japan

Plant

Brother Corporation (Asia) Ltd.,
Brother Buji Nan Ling Factory,
Gold Garden Ind., Nan Ling Village,
Buji, Rong Gang, Shenzhen, China

Herewith declare that:

Products description : Facsimile Machine
Type : Group 3 Laser
Model Name : FAX-8360P

Is in conformity with provisions of the R & TTE Directive (1999/5/EC) and we declare compliance with the following standards :

Safety : EN60950:1992 + A1:1993 + A2:1993 + A3:1995 + A4:1997 + A11:1997

EMC : EN55022:1998 Class B
EN55024:1998
EN61000-3-2:1995 + A1:1998 + A2:1998
EN61000-3-3:1995

Year in which CE marking was First affixed : 2002

Issued by : Brother Industries, Ltd.

Date : 11 March, 2002

Place : Nagoya, Japan

Signature :

Kazuhiro Dejima
Manager
Quality Audit Group
Quality Management Dept.
Information & Document Company

Using This Manual

Thank you for purchasing a Brother machine.

This machine has been designed to be simple to use, with LCD screen prompts to guide you through functions. However, you can use the machine to its fullest potential by taking a few minutes to read this manual.



Additionally, the machine has a **Reports** key. Press **Reports** and **1** to print a help list of basic operational steps and functions.

Finding Information

All chapter headings and subheadings are listed in the Table of Contents. You will also be able to find information about a specific feature or function by checking the Index at the back of this manual. Also, throughout this manual, you will see special symbols alerting you to important information, cross-references, and warnings. Illustrations of some screen displays also help you choose the correct key-presses.

Symbols Used In This Manual



Note or additional information.



The machine may be damaged or may not work correctly if this is not observed.



Warnings detail precautions you must take to avoid possible personal injury.

User-Friendly Programming

We have designed the machine with on-screen programming. User-friendly programming helps you take full advantage of all the functions the machine has to offer.

Since your programming is done on the LCD, we have created step-by-step on-screen prompts to help you program the machine. All you need to do is follow the prompts as they guide you through the function menu selections, programming options and settings. Additionally, you can program settings more quickly by pressing **Menu** and the menu number using the dial pad.

For complete list of the function selections, options, and settings, see *Menu Selection Table*, page 10.

Table of Contents

Using This Manual

User-Friendly Programming

Table of Contents	v
-------------------------	---

PREPARATION AND SIMPLE USE

Preparation and Simple Use Guide

Advice for Preparation and Simple Use Guide.....	3
FAX-8360P Control Panel Overview	8
Menu Mode	10
Menu Selection Table	10

BASIC FAX USE

Chapter 1 Setup

Initial Settings	14
Custom Settings	15
Storing Numbers for Easy Dialling.....	19

Chapter 2 Sending a Fax

Scanning Adjustment	21
Dialling a Number.....	22
Sending Operation	23

Chapter 3 Receiving a Fax

Receive Mode Settings	25
Receiving a Fax.....	28

Chapter 4 Telephone (Voice) Operation

Making Voice Calls with an External Telephone.....	30
--	----

Chapter 5 Printing Reports

Transmission Report and Journal Setting	33
Using the Reports Key	34

ADVANCED FAX USE

Chapter 6	Advanced Sending	
	Advanced Operations	35
Chapter 7	Advanced Receiving	
	Operation from an External or Extension Telephone.....	43
	Telephone Services.....	44
Chapter 8	Polling	
	Polling Receive.....	45
	Polling Transmit	47
Chapter 9	Remote Fax Options	
	Setting Fax Storage.....	48
	Fax Forwarding	48
	Remote Retrieval	49

COPIER

Chapter 10	Making Copies	
	Basic Copy Operations	52
	Temporary Copy Setting	53
	Copy Quality – Default Settings.....	57

MAINTENANCE

Chapter 11	Troubleshooting and Maintenance	
	Error Messages	61
	Document Jams and Paper jams	63
	Packing and Shipping the Machine	70
	Regular Maintenance.....	73

IMPORTANT INFORMATION

Chapter 12	Important Safety Information	
	Important Safety Instructions	83

OPTIONAL ACCESSORIES

Chapter 13	Optional Accessories	
	Memory Board.....	86
	Optional Paper Tray	89

APPENDIX

Chapter 14 Specifications

Electrical and Environment.....	91
Acceptable Paper	92
Compilation and Publication Notice.....	93
Trademarks	93
Entering Text	94
About Fax Machines	95
Glossary	96
Index	99

Preparation and Simple Use Guide

Steps to prepare and use the machine simply

Follow the steps below to prepare and use the machine simply.

However, before you perform these steps, see Important Safety Information (page 83) and Advice for Preparation and Simple Use Guide. (page 3)

If you need further information, refer to BASIC FAX USE or ADVANCED FAX USE.

1 Read the Quick Setup Guide

Follow the instructions on the Brother Quick Setup Guide to set up the machine.

2 Setting the Document

- Documents must be between 14.8 and 21.6 cm wide, and 10 and 36 cm long. This machine can only scan an image 20.7 cm wide, regardless of how wide the document is. The machine cannot scan approximately 4 mm from the top edge and the bottom edge regardless of how long the document is.
- Make sure you insert documents **face down, top edge first**.
- Adjust the paper guides to fit the width of your document.

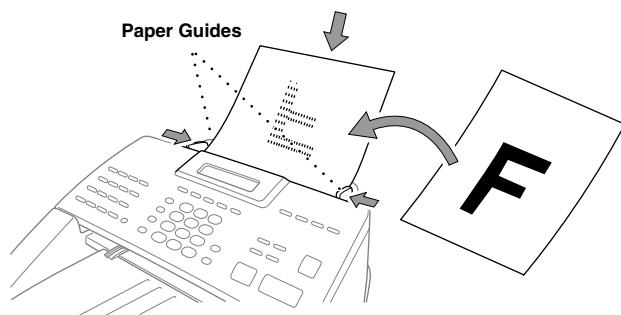

- The automatic document feeder (ADF) can hold up to 30 pages, feeding each one individually through the machine. Use standard (64 g/m^2 – 90 g/m^2) paper when using the ADF; if you're using heavier paper, feed each sheet individually to prevent paper jams.

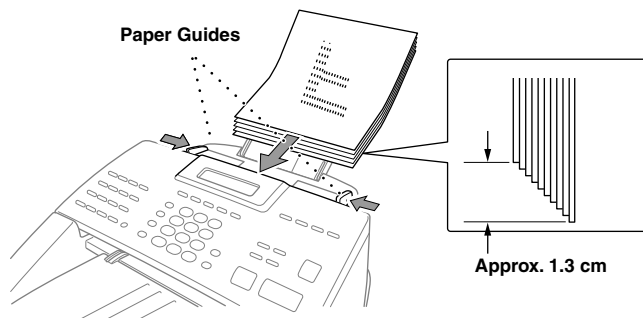



- **DO NOT** use curled, wrinkled, folded, or ripped document, or document with staples, paper clips, paste, liquid paper or tape attached. **DO NOT** use cardboard, newspaper, or fabric.
- **Make sure** documents written with ink are completely dry.

3 Sending a fax

- ① Insert the document *face down* in the ADF.
- ② Enter the fax number you want to call.
- ③ Press **Fax Start**.

4 Making a single copy

- ① Insert the document *face down* in the ADF.
- ③ Press **Copy**.
- ③ To stop copying, press **Stop/Exit**. Press **Stop/Exit** again to release the original document. (See *Making Copies*, page 52.)

5 Multiple Copies

- ① Insert the document *face down* in the ADF.
- ② Using the dial pad, enter the number of copies you want (up to 99).
For example, press **3, 8** for 38 copies.
- ③ Press **Copy**.

Advice for Preparation and Simple Use Guide

Choosing a Location

Place the machine on a flat, stable surface, such as a desk. Select a place that is free of vibration and shocks. Locate the machine near a telephone wall socket and a standard earthed electrical socket, grounded power outlet.



Avoid placing the machine where it may be knocked. Do not place near heaters, air conditioners, water, chemicals or refrigerators. Do not expose the machine to direct sunlight, excessive heat, moisture or dust. Do not connect the machine to electrical outlets controlled by wall switches or automatic timers as disruption of power can wipe out information in the unit's memory. Do not connect the machine to electrical outlets on the same circuit as large appliances or other equipment that might disrupt the power supply. Avoid interference sources, such as speakers or the base units of cordless phones. Ensure the airflow from the fan on the right hand side of the machine is not impeded.



- Never touch telephone wires or terminals that are not insulated unless the telephone line has been disconnected at the network interface.
- Avoid using a telephone (other than a cordless type) during an electrical storm. There may be a remote risk of electric shock from lightning.
- Do not use the telephone to report a gas leak in the vicinity of the leak.

Connecting the Power Cord



- This machine must be fitted with an earthed plug. If you need to use a different mains lead ensure that the machine is fitted with an earthed plug.
- Since the machine is earthed via the mains plug, you can protect yourself from potentially hazardous electrical conditions on the telephone network by keeping the power to the machine on when you connect it to a telephone line. Similarly, you can protect yourself when you want to move the machine, by disconnecting the telephone line first, and then the power cord.



IMPORTANT:

If you need to remove the moulded mains plug in order to fit an appropriate type, you must discard the moulded plug immediately having cut it off, in order that it is not inadvertently inserted into a live socket, thus presenting a shock hazard. The wires in the mains lead of this appliance are coloured in accordance with the following code.

- Green-and-yellow : Earth
- Blue : Neutral
- Brown : Live

As the wires in the mains lead of this apparatus may not correspond with the coloured markings identifying the terminals in your plug, proceed as follows:

The wire which is coloured green-and-yellow must be connected to the terminal in the plug which is marked by the letter "E" or by the safety earth symbol $\underline{\underline{=}}$ or coloured green or green-and-yellow.

The wire which is coloured blue must be connected to the terminal which is marked with the letter "N" or coloured black.

The wire which is coloured brown must be connected to the terminal which is marked with the letter "L" or coloured red.

Memory Storage

In the event of a power failure, all settings in the menus are stored permanently except for the settings that are valid for the next fax only (e.g. contrast, overseas mode), and the documents stored into memory will be stored for a few days with the backup battery. (The length of time that the documents are stored for depends on the status of the battery and the optional DIMM.)

Multi-Line Connections (PABXs)

Most offices use a central telephone system, or PABX. The machine will work with most PABX or key systems that allow a two-wire analogue connection. However, we recommend that you have a separate telephone line for the machine. You can then leave the machine in Fax Only Mode to receive faxes any time of day or night.

If you are installing the machine to work with a PABX:

- 1** It is not guaranteed that the unit will operate correctly under all circumstances with a PABX. Any cases of difficulty should be reported first to the company that handles your PABX.
- 2** If all incoming calls will be answered by a switchboard operator, it is recommended that the Receive Mode be set to **MANUAL**. All incoming calls should initially be regarded as telephone calls.
- 3** The unit may be used with either pulse or tone dialling.

Using Extension Telephones

It may be that your premises are already wired with parallel extension telephones, or you intend to add extension telephones to your line, in addition to the machine. While the simplest arrangement is straightforward parallel connection, there are some reasons as to why this arrangement will cause unsatisfactory service, the most obvious of which is inadvertent interruption of a facsimile transmission by someone picking up an extension telephone in order to make an outgoing call. Additionally, remote activation may not operate reliably in such a simple configuration.

This machine may also be set to make a delayed transmission (i.e. a transmission at a pre-set time). This pre-set job may coincide with someone picking up an extension handset.

Such problems can easily be eliminated however, if you arrange modification of your extension wiring circuit, such that extension devices are connected “downstream” of the machine, in a master/slave configuration. In such a configuration, this machine can always detect whether a telephone is in use, thus it will not attempt to seize the line during that time. This is known as “telephone off-hook detection.”

The inadvisable configuration is shown in figure 1 below, and the recommended master/slave configuration is shown in figure 2.

This new connection configuration can be arranged by your contacting BT, Kingston upon Hull Telecommunications, your PABX maintainer or a qualified telephone installation company as appropriate. Simply explained, the extension telephone circuit should be terminated on a normal modular plug (BT 431A style), which in turn should be inserted into the modular socket of the white “T”-shaped connector provided as part of the line cord assembly.

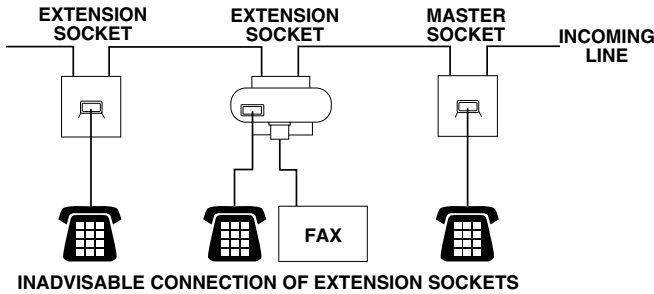
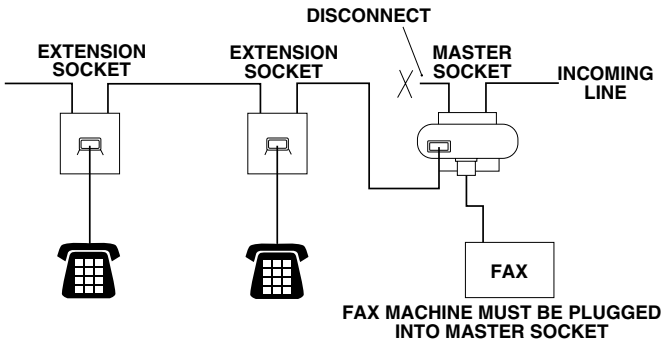

Fig. 1.



RECOMMENDED CONNECTION OF EXTENSION SOCKETS

Fig. 2.

Connecting an External Telephone Answering Device (TAD)

Sequence

You may wish to connect an external answering machine. When you have an **external** TAD on the same telephone line as the machine, the TAD answers all calls. The machine “listens” for fax calling (CNG) tones. If it hears them, the machine takes over the call and receives the fax. If it doesn’t hear the CNG tones, the machine will not answer the call, and messages can be left on the TAD by callers in the normal way.

The TAD must answer within a maximum of four rings. However, we recommend two rings as the TAD setting. The machine cannot hear CNG tones until the TAD has answered the call, and with four rings there are only 8–10 seconds of CNG tones left for the fax “handshake.” Make sure you carefully follow instructions in this manual for recording your outgoing message. Do not use a “toll-saver” ring setting on the TAD.



It is important that the TAD is connected via the EXT socket on the machine or on the line jack unit. Do not use a line doubler on the line jack as this can cause answering problems.

Connections

1 You may connect an external TAD to the machine, as shown below.

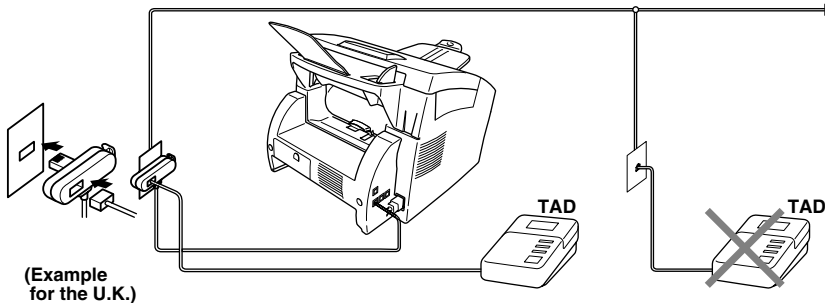

- 2** Set your external TAD to two rings or less.
- 3** Record the outgoing message (see next page).
- 4** Set the TAD to answer calls.
- 5** Set the Receive Mode to **TAD** by pressing **Mode** key.

Outgoing Message (OGM) of External TAD

Timing is important in recording this message. The message sets up the ways to handle both manual and automatic fax reception.

- 1 We recommend the outgoing message (OGM) is no longer than 20 seconds.
- 2 Allow 5 seconds of silence at the beginning of your message.
(This allows the fax to detect the calling tone prior to OGM, so reception can be faster.)
- 3 We recommend that you end your OGM by giving your Remote Activation Code for people sending manual faxes. For example:
“After the beep, leave a message or send a fax manually by pressing *51 and Start”

Please note that some faxes that are sent manually cannot be received automatically because some fax machines do not send a fax tone if the call is manually dialed. In these cases you must inform callers that they must enter the remote activation code to send a fax.

Connecting an External or Extension Telephone

You can connect a separate telephone to the machine, as shown below.

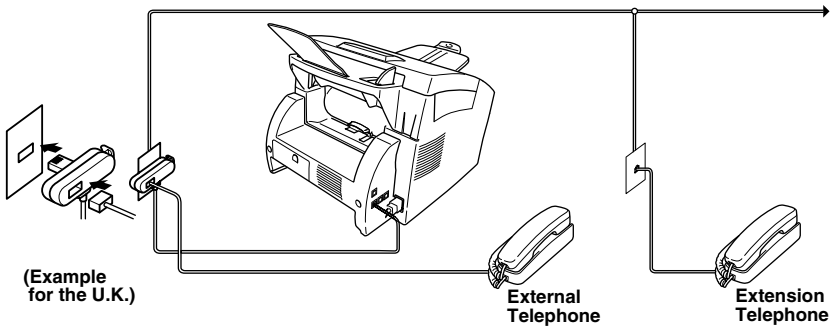

Whenever this external phone (or TAD) is in use, the screen displays **TELEPHONE**.

FAX-8360P Control Panel Overview

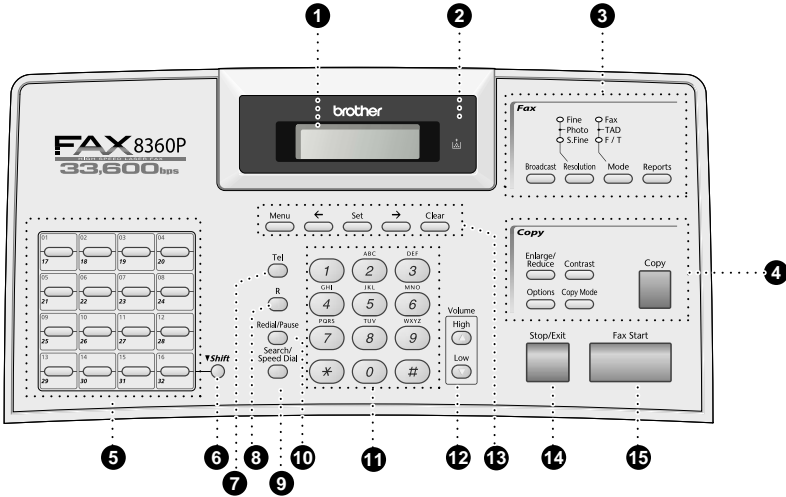

1 Liquid Crystal Display

Displays messages to help you set up and operate the machine.

2 Toner Empty LED

The Toner Indicator flashes on and off when toner is low, so you will know to order another toner cartridge. You will still be able to print until the Indicator stays on.

3 Fax Keys/LEDs:

Resolution Indicator Lights

These LEDs show the resolution mode you selected.

Receive Mode Indicator Lights

These LEDs show how the machine will handle incoming calls.

Broadcast

Use this key when you want to send a fax to several different locations (maximum 282 locations at once).

Resolution



Sets the resolution when you send a fax.

Mode

Select how the machine will handle incoming calls.

Reports

Accesses the Reports menu so you can select a report to print: Help, Quick Dial, Journal, Xmit Verify, System Setup List and Order Form.



- 4 Copy Keys:**
Enlarge/Reduce
 Lets you select an enlargement or reduction ratio: 50%, 71%, 100%, 141%, 150%, 200%. For more choices, select **MANUAL** and use dial pad to type any percentage between 50% and 200%.
- Options**
 You can quickly and easily select temporary settings (for the next copy only).
- Contrast**
 Press this key to temporarily change the contrast.
- Copy Mode**
 Select the copy resolution for your type of original document.
- Copy**
 Makes a copy.
- 5 One Touch Dial Keys**
 These 16 keys give you access to 32 previously stored phone numbers.
- 6 Shift**
 This key is used to access the “17” through “32” One Touch keys.
- 7 Tel (Telephone)**
 This key is used to have a telephone conversation having picked up the external handset in F/T pseudo-ringing etc.
- 8 R (Recall)**
 Use this key to gain access to an outside line and/or to recall the operator or transfer a call to another extension when it is connected to a PABX.
- 9 Search/Speed Dial**
 Lets you look up numbers stored in the dialling memory. Also, lets you dial stored phone numbers by pressing **#** and three-digit number.
- 10 Redial/Pause**
 Re-dials the last number called. Also inserts a pause in autodial numbers.
- 11 Dial Pad**
 Dials phone and fax numbers and can be used as a keyboard for entering information into the machine.
key lets you switch the dialling type during a telephone call from “**PULSE**” to “**TONE**”.
- 12 Volume High / Low**
 Lets you adjust speaker and ring volume.
- 13 Programming Keys:**
Menu
 Lets you access the function and programming mode.
 (**Left Arrow**)
 Moves the LCD cursor to the left and displays the previous menu option/function.
 Also, you can use this key to do an alphabetical search for the names of stored numbers.
- Set**
 Stores a function setting into the machine.
 (**Right Arrow**)
 Moves the LCD cursor to the right and displays the next menu option/function.
 Also, you can use this key to do an alphabetical search for the names of stored numbers.
- Clear**
 Deletes entered data or moves back one step in function menu.
- 14 Stop/Exit**
 Stops a fax, cancels an operation or exits from function mode.
- 15 Fax Start**
 Starts an operation (such as Sending a fax).

Menu Mode

After pressing **Menu** key the following options are available.

Then press **1** for General Setup Menu—**OR**—Press **2** for Fax Menu—**OR**—Press **3** for Copy Menu.

When you enter the Menu Mode, the machine displays a list of Level One Menus from which you can choose. These menu options appear one after the other on the display. Select an option by pressing **Set** when the option appears on the LCD.

You can “scroll” more quickly through options by pressing . When the screen displays your selection, press **Set**. (Use  to scroll backward if you passed your choice or to save key strokes. Both arrow keys show all options, in the opposite order.)

When you finish selection, the screen displays **ACCEPTED**.



If you want to exit the Menu Mode, press **Stop/Exit**.

Menu Selection Table

If you have a basic understanding of how to program your machine, you can perform most of the programming settings without the Owner’s Manual. To help you understand the function selections, options, and settings that are available, use the Menu Selection Table below.

Main Menu	Submenu	Menu Selections	Options	Descriptions	Page	
1. GENERAL SETUP	1. DATE/TIME	—	—	Enter date and time for LCD display and to print on transmission reports and so on.	14	
	2. STATION ID	—	—	Program the name and fax number to appear on each transmitted page.	14	
	3. VOLUME	1. RING	HIGH MED LOW OFF		Adjusts ring volume.	15
		2. BEEPER	HIGH LOW OFF		Adjusts beeper volume.	15
		3. SPEAKER	HIGH MED LOW OFF		Adjusts speaker volume.	15
4. PBX	—	ON OFF	Turn on this function if the machine is connected to PABX (private automatic Branch Exchange.)	16		

* The factory setting (option) is shown in bold.

Main Menu	Submenu	Menu Selections	Options	Descriptions	Page
1. GENERAL SETUP (Continued)	5. CLOCK CHANGE	—	—	Adjusts the machine's clock by one hour for summer/winter time.	16
	6. TONER SAVE	—	ON OFF	Increases the life of the toner cartridge.	17
	7. POWER SAVE	—	ON OFF	Power save mode. Reduces power consumption.	17
	8. SLEEP MODE	—	—	Sets the time before the machine goes into sleep mode.	17
	9. TONE/PULSE	—	TONE PULSE	Selects the dialling mode.	18
	0. LOCAL LANGUAGE (For Czech, Hungarian and Polish)	—	CZECH HUNGARIAN POLISH ENGLISH	Allows you to change the LCD language.	See Quick Setup Guide
2. FAX	1. SETUP RECEIVE	1. RING DELAY	04 03 02 01	Sets the number of rings before the machine answers in Fax/Tel (F/T) or Fax Mode.	26
		2. F/T RING TIME	70 40 30 20	Sets the time for "F/T pseudo-ring" in Fax/Tel (F/T) Mode.	26
		3. FAX DETECT	ON OFF	Receive fax messages without pressing the Fax Start key when you answer the call with an external telephone.	27
		4. REMOTE CODE	ON (*51, #51) OFF	Activate or deactivate the machine from a remote location. You can also personalize these codes.	44
		5. AUTO REDUCTION	ON OFF	Reduces the size of an image.	28
		6. MEM. RECEIVE	ON OFF	Automatically stores any incoming faxes in its memory if it runs out of paper.	29
		7. PRINT DENSITY	-■□□□+	Adjusts printing to be lighter or darker.	28
		8. POLLING RX	STANDARD SECURE TIMER	You call another fax machine to receive a fax from it.	45

* The factory setting (option) is shown in bold.

Main Menu	Submenu	Menu Selections	Options	Descriptions	Page
2. FAX (Continued)	2. SETUP SEND	1. CONTRAST	AUTO LIGHT DARK	Changes the lightness or darkness of a fax you are sending.	21
		2. FAX RESOLUTION	STANDARD FINE S.FINE PHOTO	Changes the default setting of fax resolution.	21
		3. TIMER	—	Sets the machine to send your documents later.	37
		4. BATCH TX	ON OFF	Sends all delayed faxes that are to the same fax number and at the same time as one transmission.	37
		5. REAL TIME TX	NEXT FAX ONLY ON OFF	When memory is full, you can send faxes in real time.	24
		6. POLLED TX	STANDARD SECURE	Sets a Polled Transmission for someone to poll the machine to receive a fax from you.	47
		7. COVERPG SETUP	NEXT FAX ONLY ON OFF PRINT SAMPLE	Automatically sends a programmable cover page or prints a sample coverpage.	35
		8. COVERPAGE NOTE	—	Program a customized message for fax cover page.	36
		9. OVERSEAS MODE	ON OFF	Special setting for international transmissions.	37
	3. SET QUICK-DIAL	1. ONE-TOUCH DIAL	—	Stores dial numbers in memory so as to dial them by pressing only one key.	19
		2. SPEED-DIAL	—	Stores dial numbers in memory so to dial them you only have to press five keys.	19
		3. SETUP GROUPS	—	Set up a Group for broadcasting.	39
	4. REPORT SETTING	1. XMIT REPORT	ON ON+IMAGE OFF OFF+IMAGE	Initial setup for Transmission Verification Report and Journal period.	33
		2. JOURNAL PERIOD	EVERY 50 FAXES 6/12/24 Hours 2/7 Days OFF		33

* The factory setting (option) is shown in bold.

Main Menu	Submenu	Menu Selections	Options	Descriptions	Page	
2. FAX (Continued)	5. REMOTE FAX OPT	1. FAX FWD	ON OFF	Sets the machine to forward faxes.	48	
		2. FAX STORAGE	ON OFF	Stores incoming faxes in memory for fax forwarding and remote retrieval.	48	
		3. REMOTE ACCESS	159 *	Sets the code for retrieving faxes.	49	
		4. PRINT DOCUMENT	—	Print incoming faxes stored in the memory.	29	
		5. BACKUP PRINT	ON OFF	Prints a copy of faxes as they are received into memory.	48	
	6. REMAINING JOBS	—	—	Check which jobs are in memory or cancel a delayed fax (timer) or polling job.	40	
	0. MISCELLANEOUS	1. MEM SECURITY	—	—	Prohibits most functions except receiving faxes into memory.	41
		2. LOWER TRAY (with optional cassette only)	ON OFF	Turn ON if you use the optional paper tray (Lower Cassette), and choose which cassette you want to use for receiving faxes or copying.	18	
		3. DRUM LIFE	—	—	You can check the remaining drum life on the screen.	80
		4. BT CALL SIGN (For U.K. Only)	ON OFF	—	Use with BT Call Sign.	44
3. COPY	1. COPY MODE	—	AUTO TEXT PHOTO	Selects the Copy resolution for your type of document.	58	
	2. CONTRAST	—	-■■■■□□+	Adjusts the contrast.	58	
	3. PAPER TYPE	—	THIN PLAIN THICK THICKER	Identify the type of paper in the paper tray.	58	

* The factory setting (option) is shown in bold.

1 Setup

Initial Settings

Setting the Date and Time

The machine displays the date and time, and prints it on every fax you send.

In the event of a power failure, the machine maintains date and time information for several hours.

- 1 Press **Menu**, **1**, **1**.
- 2 Enter the two digits of the year, and press **Set**. “02” is registered as 2002 in the machine.
- 3 Enter two digits for the month and press **Set**.
- 4 Enter two digits for the day and press **Set**.
- 5 Enter the time in 24 hour format and press **Set**.
- 6 Press **Stop/Exit**.

Setting the Station ID

You can store your name, fax number and telephone number in this setting. The name and fax number will be printed on the fax cover pages and all fax pages that you send. (The telephone number will be printed only on your cover pages.) (See *Electronic Cover Page*, page 35.)

It is important that you enter the fax and telephone numbers in the internationally standardized format, i.e. in accordance with the following strict sequence:

- The “+” (plus) character (press * key)
- Your Country Code (e.g. “44” for the United Kingdom, “41” for Switzerland)
- Your local area code minus any leading “0” (“9” in Spain)
- A space
- Your number on the local exchange, using spaces to aid readability as appropriate.

As an example, if the machine is installed in the United Kingdom and the same line is to be used for both fax and voice calls, and your national telephone number is 0161-444 5555, then you must set the fax and telephone number parts of your station ID as: +44 161-444 5555

- 1 Press **Menu**, **1**, **2**.
- 2 Enter your fax number (up to 20 digits) and press **Set**.
- 3 Enter your telephone number (up to 20 digits) and press **Set**.
- 4 Enter your name (up to 20 characters) using the dial pad. To enter a space press  twice.
- 5 Press **Set**.
- 6 Press **Stop/Exit**.



- When you enter your name, see *Entering Text*, page 94.
- The telephone number you enter is used only for the Cover Page features.
- If you do not enter a fax number, no additional information can be entered.
- To enter a space, press  once between numbers and twice between characters.
- If your Station ID has already been programmed, the screen prompts “1” to make a change, or “2” to exit without changing.

Custom Settings

Volume Settings

Ring Volume

You can select how loud, the machine rings. The ring volume can be turned off for silent reception if required.

- 1 Press **Menu, 1, 3, 1.**
- 2 Press **←** or **→** to select **OFF, LOW, MED, or HIGH.**
- 3 Press **Set** when the screen displays your selection.
- 4 Press **Stop/Exit.**

—OR—

You can adjust the ring volume when the machine is idle. You can turn the ring OFF.

Press **High** or **Low** to adjust the volume level. With each key press, the machine rings so you can hear the current setting and the display shows the setting you are choosing. Each key press changes the volume to the next setting.

The new setting will remain until you change it again.

Beeper Volume

You can set the beeper to **LOW, HIGH** or **OFF**. The machine comes with this volume set to **LOW**. When the beeper is set to **LOW** or **HIGH**, the machine beeps every time you press a key or make an error, and at the end of sending or receiving a fax.

- 1 Press **Menu, 1, 3, 2.**
- 2 Press **←** or **→** to select your setting.
- 3 When the screen displays the setting you want, press **Set.**
- 4 Press **Stop/Exit.**

Speaker Volume

You can set the volume of the machine speaker.



- 1 Press **Menu, 1, 3, 3.**
- 2 Press **←** or **→** to select your volume setting (**OFF, LOW, MED, or HIGH**).
- 3 Press **Set** when the screen displays your selection.
- 4 Press **Stop/Exit.**

PABX and TRANSFER

The machine is initially set to be connected with PSTN (Public Switched Telephone Network) lines. However, many offices use a central telephone system or Private Automatic Branch Exchange (PABX). Your fax can be connected to most types of PABX. The recall facility on the machine supports timed break recall only (TBR), PBXS normally can work with this for gaining access to an outside line, or for transferring a call to another extension: The feature works when the **R** key is pressed.

Setting PABX

If the machine is connected to a PABX system, set **PBX:ON**. If not, set **OFF**.

- 1 Press **Menu, 1, 4**.
- 2 Press  or  to select **ON** (or **OFF**).
- 3 Press **Set** when the screen displays your selection.
- 4 Press **Stop/Exit**.





You can program an **R** key press as part of a number stored in a One Touch or Speed Dial location. When programming the One Touch or Speed Dial number (Function menu 2-3-1 or 2-3-2) press **R** first (the screen displays “!”), then enter the telephone number. If you do this, you do not need to press **R** each time before you dial using a One Touch or Speed Dial location. (See *Storing Numbers for Easy Dialling*, page 19.)

However, if **PBX** is set to **OFF**, you can't use the One Touch or Speed Dial number that the **R** keypress is programmed into.

Setting the Clock Change

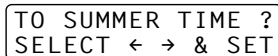

You can easily let the machine's clock gain or lose one hour by using this feature.

- 1 Press **Menu, 1, 5**. The screen displays
- 2 Press  or  to select Summer Time to gain an hour or Winter time to lose an hour, and press **Set**.
- 3 Press **1** to change to Winter Time or Summer Time—**OR**—Press **2** to exit without changing.



Toner Save

You can conserve toner using this feature. When you set Toner Save to **ON**, print appears somewhat lighter. The default setting is **OFF**.

- 1 Press **Menu, 1, 6**.
- 2 Press  or  to select **ON** (or **OFF**).
- 3 Press **Set**.
- 4 Press **Stop/Exit**.

Sleep Mode



Setting the Sleep Mode reduces power consumption by turning off the fuser inside the machine, while the machine is idle. You can choose how long the machine is idle (from 00 to 99 minutes) before it drops into sleep mode. The timer automatically resets when the machine receives a Fax, or makes a copy. The factory setting is 05 minutes. While the machine is in sleep mode, you will see **SLEEP** in the LCD. When you try to print a fax/list or copy in sleep mode, there will be a short delay whilst the fuser warms up to working temperature.

- 1 Press **Menu, 1, 8**.
- 2 Use the dial pad to enter the amount of time the machine is idle before it drops into sleep mode (00 to 99).
- 3 Press **Set**.
- 4 Press **Stop/Exit**.

Power Save

Setting Power Save Mode by turning off the CPU inside the machine reduces power consumption more than Sleep Mode. If Power Save Mode is switched **ON**, when the machine is idle, it drops into power save mode automatically. In the Power Save Mode, you cannot use fax detect function or remote activation.

The machine will not display the date and time in this condition.

- 1 Press **Menu, 1, 7**.
- 2 Press  or  to select **ON** (or **OFF**).
- 3 Press **Set** when the screen displays your selection.
- 4 Press **Stop/Exit**.

Setting the Dialling Mode (Tone/Pulse)

The machine is initially set to **TONE**. If you are using a **PULSE** dial line, you can change the setting to **PULSE** by following the steps below.

- 1 Press **Menu, 1, 9**. The screen prompts you to select **PULSE** (or **TONE**).
- 2 Use **←** or **→** to select the dialling mode.
- 3 Press **Set** when the screen displays the dialling mode you want.
- 4 Press **Stop/Exit**.

Lower Tray (With Optional Paper Tray Only)

You can set the machine to recognize the optional lower tray. When Lower Tray is set to **ON**, you can set which tray you want to use for faxes or for copies.

- 1 After setting up the optional paper tray, press **Menu, 2, 0, 2**.
- 2 Press **←** or **→** to turn **ON** (or **OFF**).
- 3 Press **Set**.

When the optional **LOWER TRAY** is set to **ON**, you can set the tray usage.

The default setting of **AUTO** allows the machine to choose the lower tray if paper is out in the upper tray. Choose **UPPER** or **LOWER** if you want to keep special paper in the other tray and control when it is used.

- 4 To set tray usage for faxes, press **←** or **→** to select **FOR FAX**, and then press **Set**.
—OR—
To set tray usage for copies, press **←** or **→** to select **FOR COPY**, and then press **Set**.
- 5 Press **←** or **→** to select **AUTO**, **UPPER** or **LOWER** and press **Set**.
- 6 Press **Stop/Exit**.

Storing Numbers for Easy Dialling

You can set up the machine to do three types of easy dialling: One Touch, Speed Dial and Groups for Broadcasting of faxes. (See *Broadcasting*, page 38.)

Even if you lose electrical power, numbers stored in memory will not be lost.

Storing One Touch Dial Numbers

You can store 32 fax/phone numbers that you can dial by pressing one key. You can also store names with these numbers. When you press a One Touch key, the screen displays the name or number as the call is dialled. (See *One Touch Dialling*, page 22.)



One Touch Dial keys are not the dial pad keys. They are the 16 keys (numbers 1-32). One Touch Dial Numbers 17-32 are accessed by holding down **Shift** while you press the appropriate One Touch Dial key.

- 1 Press **Menu, 2, 3, 1**.
- 2 Press the One Touch Dial key where you want to store a number. The screen displays the location you selected.
- 3 Enter a number (up to 20 digits), and press **Set**. The screen prompts you to enter a name for this number.
- 4 Use the dial pad to enter the name (up to 15 characters). (See *Entering Text*, page 94.)—**OR**—Go to Step 5 to store the number without a name.
- 5 Press **Set**. Return to Step 2 to store another One Touch dial number—**OR**—Press **Stop/Exit**.

When you dial a One Touch dial number, the screen displays the name you have stored or if you have not stored a name, the number you have stored.

Storing Speed Dial Numbers

You can store Speed Dial numbers, which you dial by pressing only five keys. There are 200 Speed Dial locations. (See *Speed Dialling*, page 31.)

- 1 Press **Menu, 2, 3, 2**.
The screen prompts you to enter a location.
- 2 Use the dial pad to enter a three-digit location (001-200), and press **Set**. The screen displays your entry, then prompts you to enter the number you're storing.
- 3 Enter the number (up to 20 digits), and press **Set**.
The screen now prompts you to store a name with this number.
- 4 Use the dial pad to enter the name (up to 15 characters). (See *Entering Text*, page 94.)—**OR**—Go to Step 5 to store the number without a name.
- 5 Press **Set**. Return to Step 2 to store another Speed Dial number—**OR**—Press **Stop/Exit**.

When you dial a Speed dial number, the screen displays the name you have stored or if you have not stored a name, the number you have stored.

Changing One Touch and Speed Dial Numbers

If you try to store a One Touch or Speed Dial number in a location where a number is already stored, the screen displays the current name stored there, then prompts you to either change it or exit.



1 Press **Menu, 2, 3, 1** and press the One Touch Dial key where you want to change the number.
—OR—

Press **Menu, 2, 3, 2** and use the dial pad to enter a three-digit location (001-200), and press **Set**.

2 Press **1** to change the number stored, or press **2** to exit without making a change.

3 Enter a new number.

◆ If you want to erase the number, press **Clear** when the cursor is to the far left of the digits.

◆ If you want to change a digit, use  or  to position the cursor under the digit you want to change, then enter the new digit—OR—Press **Clear** to delete all characters above and to the right of the cursor.

4 Follow the directions in Storing One Touch Dial or Speed Dial Numbers.



You can print a list of all stored numbers. (See *Using the Reports Key*, page 34.)

Scanning Adjustment

Contrast

If your document is very light or very dark, you might want to set the contrast accordingly. Use **LIGHT** to send a light document. Use **DARK** to send a dark document. After sending the document the contrast setting is set to **AUTO** (suitable for most documents) automatically.

- 1 Insert the document face down in the ADF.
- 2 Press **Menu, 2, 2, 1**.
- 3 Use **←** or **→** to select **AUTO**, **LIGHT**, or **DARK**.
- 4 When the screen displays your selection, press **Set**.
- 5 Press **2** if you are finished choosing settings, and go to Step 6—**OR**—Press **1** if you want to select additional settings. The display returns to Setup Send menu.
- 6 Enter a fax number and press **Fax Start**.

Fax Resolution

When you have a document in the ADF, you can use the **Resolution** key to temporarily change the setting. Press **Resolution** repeatedly until the LEDs show the setting you want.

—**OR**—

You can change the default setting.

- 1 Press **Menu, 2, 2, 2**.
- 2 Press **←** or **→** to select the resolution you want, and then press **Set**.
- 3 Press **2** if you are finished choosing settings—**OR**—Press **1** if you want to select additional settings. The display returns to Setup Send menu.
- 4 Press **Stop/Exit**.

STANDARD: Suitable for most typed documents.

FINE: Good for small print; transmits a little slower than Standard resolution.

S.FINE: Good for small print or artwork; transmits slower than Fine resolution.

PHOTO: Use when document has varying shades of grey; slow transmission time.

Dialling a Number

One Touch Dialling

- 1 Insert the document face down in the ADF.
- 2 Press the One Touch key of the location you want to call.
- 3 Press **Fax Start**.





If you try to use a One Touch or Speed Dial location with no number stored in it, you hear a warning sound, and screen displays **NOT ASSIGNED**. The display returns to normal after 2 seconds.

Speed Dialling

- 1 Insert the document face down in the ADF.
- 2 Press **Search/Speed Dial**, then press **#** and the three-digit Speed Dial number.
- 3 Press **Fax Start**.

Search

You can search for names you have stored in One Touch and Speed Dial memories. (See *Storing One Touch Dial Numbers*, page 19 and *Storing Speed Dial Numbers*, page 19.)

- 1 Insert the document face down in the ADF.
- 2 Press **Search/Speed Dial**.
- 3 To search for numbers alphabetically by name, enter the first letter of the name by using the dial pad, and then press  or .
- 4 When the screen displays the name you want to call, press **Fax Start**.

Chain Dialling

You can store very long dialling sequences by dividing them and setting them up as One Touch and Speed Dial numbers. Then while dialling, you can combine two or more One Touch and/or Speed Dial numbers and even include manual dialling using the dial pad. You can use these numbers in any combination. The combined number will be dialled, in the order you entered it, as soon as you press **Fax Start**.

For example:

You can store “555” on One Touch Dial key **01** and “7000” on One Touch Dial key **02**. If you press One Touch **01**, **02** and **Fax Start**, you can dial “555 7000”. To temporarily change a number, you can substitute part of the number with manual dialling using the dial pad. So, if you press One Touch **01** and press **7001** using the dial pad, you can dial “555 7001”.

Using access codes is easy. Sometimes you may want to choose from the among several long distance carriers when you make a call; rates may vary depending upon the time and destination. To take advantage of low rates, you can store the access codes or long-distance carriers as One Touch and Speed Dial numbers.

Automatic and Manual Fax Redial

Automatic Fax Redial: If you are sending a fax automatically and the line is busy, the machine will automatically redial up to 3 times at 5 minutes intervals.

Manual Fax Redial: Place the document to be re-sent and press **Redial/Pause** and then **Fax Start** to make a second call to the last number dialled.

Pause

Press **Redial/Pause** to insert a pause between digits to be dialled.



If the machine is connected to a PABX, you may need to insert an additional number prefix (e.g. "9") and a "pause" before each fax or telephone number to gain access to the outside line. When you press **Redial/Pause**, a dash "-" will appear on the display. By storing a pause, you can create a delay of 3.5 seconds.

Sending Operation

Automatic Transmission

This is the easiest way to send a fax.

IMPORTANT: Do not pick up the external telephone's handset.

- 1 Insert the document face down in the ADF.
- 2 Enter the fax number using One Touch, Speed Dial, Search or the dial pad.
- 3 Press **Fax Start**.

Manual Transmission (With an External Telephone)

Manual transmission lets you hear the dial tone, ringing and fax receiving tones before sending a fax.

- 1 Insert the document face down in the ADF.
- 2 Pick up the handset of the external telephone and listen for a dial tone.
- 3 Enter the fax number you want to call. (You can dial the number by using One Touch, Speed Dial, Search or dial pad.) (See *Dialling a Number*, page 22.)
- 4 When you hear the fax tone, press **Fax Start**.
- 5 Return the handset of the external telephone to its cradle.

Dual Access

You can scan up to 50 messages into the fax memory, even while the machine is receiving or sending another fax (from the memory). You can set temporary settings for each fax you're scanning, except Timer and Polling.

If you get an **OUT OF MEMORY** message while scanning the first page of a fax, press **Stop/Exit** to cancel the scan. If you get an **OUT OF MEMORY** message while scanning in a subsequent page, you will have the option to press **Fax Start** to transmit the pages scanned so far, or to press **Stop/Exit** to cancel the operation.

- 1 Insert the document face down in the ADF.
- 2 Enter the fax number.
- 3 Press **Fax Start**. The machine starts scanning the document and the screen displays the job number (#XXX) of the fax, and how much memory is available. When the machine starts dialling you can immediately repeat Steps 1 through 3 for the next fax.

Real Time Transmission

When you are sending a fax, the machine will scan documents into memory before sending. Then, as soon as the phone line is free, the machine will start dialling and sending the fax. If memory becomes full, the machine will send the document in real time (even if **REAL TIME TX** is set to **OFF**).

Sometimes you may want to send an important document immediately, without waiting for memory transmission. You can set **REAL TIME TX** to **ON**.

- 1 Insert the document face down in the ADF.
- 2 Press **Menu, 2, 2, 5**.
- 3 To change the default setting, press **←** or **→** to select **ON** (or **OFF**) and press **Set**. Go to Step 6—**OR**—For the next fax transmission only, press **←** or **→** to select **NEXT FAX ONLY**.
- 4 Press **Set**.
- 5 For the next fax only, press **←** or **→** to select **ON** (or **OFF**) and press **Set**.
- 6 Press **1** if you want to select additional settings. The display returns to the **SETUP SEND** menu—**OR**—Press **2** if you have finished choosing settings and go to Step 7.
- 7 If you switched ON Real Time Transmission for the next fax only, enter the fax number and press **Fax Start**.

Receive Mode Settings

Select Receive Mode



There are four different receive modes for the machine. You may choose the mode that best suits your needs by pressing the **Mode** key repeatedly until you have changed the **Fax** and **F/T** lights to the setting you want to use.

You will need to connect an external telephone to select Fax/Tel (F/T) or Manual Mode or an external TAD to select TAD Mode.

Receive Mode		For
(<input type="radio"/> means light off. <input checked="" type="radio"/> means light on.)		
1. FAX	<input checked="" type="radio"/> Fax <input type="radio"/> TAD <input type="radio"/> F/T	Use this function if you want to receive fax messages only (no telephone calls). The machine should be connected on its own line. The machine automatically answers every call as a fax call. You cannot receive a voice call, but, if you have connected an External telephone, you can still dial out and make voice calls. (This setting is recommended if the machine is on its own dedicated line.)
2. FAX/TEL (F/T) (with an External Telephone)	<input type="radio"/> Fax <input type="radio"/> TAD <input checked="" type="radio"/> F/T	Use this function if you expect to receive many fax messages and few phone calls. The machine automatically answers every call. If the call is a fax, it prints the fax. If the call is not a fax, it signals you with an F/T pseudo-ring, different from the phone company ringing, to alert you to pick up the call. Lift the external telephone's handset, and then press Tel to answer. If you select this setting, you will need to set the Ring Delay and F/T Ring Time features (on the following pages).
3. TAD (with an External Answering Machine)	<input checked="" type="radio"/> Fax <input type="radio"/> TAD <input checked="" type="radio"/> F/T	This is the only setting in which you can use an external answering machine. Your telephone answering device answers every call. Once the external telephone answering device (TAD) answers, the machine listens for fax tones. If it detects fax tones, fax messages are printed. (See <i>Connecting an External Telephone Answering Device (TAD)</i> , page 6.)
The TAD setting works only with an external telephone answering device (TAD). Ring Delay and F/T Ring Time do not work in this setting.		
4. MANUAL (with an External Telephone)	<input type="radio"/> Fax <input type="radio"/> TAD <input type="radio"/> F/T	Use this function if you receive many telephone calls and few fax messages. You must answer all calls yourself. If you hear fax tones, wait until the machine takes over the call automatically, then hang up (see Fax Detect function).



Manual Reception (Manual Mode)

When you set the Receive Mode to manual (the **Fax** and **F/T** lights are both off), you must answer each incoming call yourself with an external telephone. Select this mode by pressing **Mode** key. Here is what you should do when using Manual Mode:

If You Get a...	Then You Should...
1. Regular phone call	Talk as you normally would.
2. Phone call and request to send a fax	Press Fax Start when finished talking, and replace the external telephone's handset. NOTE: Sender must also press Start.
3. Fax tone...	Wait until the fax machine takes over the call or press Fax Start .



Setting the Ring Delay

The Ring Delay setting determines the number of times the machine rings before it answers in FAX ONLY or FAX/TEL mode. (See *Operation from an External or Extension Telephone*, page 43. Also see *For Fax/Tel Mode Only*, page 43.)

- 1 Press **Menu, 2, 1, 1**.
- 2 Press  or  to select how many times the line rings before the machine answers (01-04).
- 3 Press **Set** when the screen displays your selection.
- 4 Press **Stop/Exit**.

Setting the F/T (Fax/Tel) Ring Time (Fax/Tel Mode Only)

You need to determine how long the machine will notify you with its special F/T pseudo-ring when you have a voice call. This ringing happens after the initial ringing from the phone company. Only the machine rings, for 20, 30, 40 or 70 seconds; no other phones on the same line ring the special F/T pseudo-ring. However, you can answer the call on any extension phone (in a separate wall socket) on the same line as the machine. (See *Operation from an External or Extension Telephone*, page 43.)

- 1 Press **Menu, 2, 1, 2**.
- 2 Press  or  to select how long the machine will ring to alert you that you have a voice call, and then press **Set**.
- 3 Press **Stop/Exit**.

Now, when a call comes in and the machine is set to Fax/Tel (F/T) Mode, all phones on this line will ring the number of times you selected in Ring Delay.

You can let the machine pick up and detect if it's a fax or voice call. If it's a fax call, the machine prints the fax. If it's a voice call, the machine signals you with an F/T pseudo-ring for the length of time you selected in F/T Ring Time. Lift the external telephone's handset, and then press **Tel** to answer.





Even if the caller hangs up during the F/T pseudo-ringing, the machine continues the F/T pseudo-ringing for the set time.

Fax Detect (with an External or Extension Telephone)

When you use this feature, you don't have to press **Fax Start** or * 5 1 when you answer a fax call with an external or extension telephone and hear calling beeps. Just hold the handset of an external or extension telephone and wait for several seconds. When you see **RECEIVING** on the fax screen or when you hear "chirps" through the handset of an extension phone connected to another wall socket, just replace the handset, and the machine does the rest. Selecting **ON** allows the machine to receive fax calls automatically, even if you lift the handset of an external or extension phone.

Selecting **OFF** means you will have to activate the machine yourself, by pressing **Fax Start** or * 5 1 at the external or extension telephone. (You have to set Remote Activation to **ON** in **Menu, 2, 1, 4** to use * 5 1.) (See *Operation from an External or Extension Telephone*, page 43.)

In case Fax Detect does not work, because of a poor phone line connection, just press the Activation Code * 5 1 at the external or extension telephone.

- 1** ▶ Press **Menu, 2, 1, 3**.
- 2** ▶ Use  or  to select **ON** or **OFF** and press **Set**.
- 3** ▶ Press **Stop/Exit**.

Receiving a Fax



Printing a Reduced Incoming Document (Auto Reduction)

If you choose **ON**, the machine reduces an incoming document automatically, so that it fits on one page of A4 recording paper, regardless of the size of the original document.

After you connect the optional lower tray, you can turn on Automatic Reduction for both tray.



Lower Tray can be purchased.

- 1 Press **Menu, 2, 1, 5**. The screen displays
- 2 Use  or  to select **ON** (or **OFF**).
- 3 Press **Set** when the screen displays your selection.
- 4 Press **Stop/Exit**.

5. AUTO REDUCTION





If you receive faxes that are split on two pages, change this setting to **ON**.



- When you use Auto Reduction to reduce incoming documents to fit on one page of recording paper, you can do so only as long as the original document is not longer than 35 cm. If the original is longer than 35 cm, the data will not be reduced and will carry over to print on a second page.
- When you use Auto Reduction and you receive an incoming document that is smaller than your recording paper, no reduction will take place, and you will get the same size recorded as the original.

Setting the Print Density

If the machine is printing too light or too dark, you can adjust the print density level. The new setting will remain until you change it again. This setting also adjusts that of copy function.

- 1 Press **Menu, 2, 1, 7**.
- 2 Press  or  to select your setting. Each key press changes the print density to the next setting.
- 3 When the screen shows the setting you want, press **Set**.
- 4 Press **Stop/Exit**.

Reception into Memory

As soon as the paper tray becomes empty during fax reception, the screen will display “**CHECK PAPER**”. Please put some paper in the paper tray.

If the MEMORY RECEPTION switch is ON at this time...

The current fax reception will continue, with the remaining page(s) being stored in memory, subject to available memory. Subsequent incoming faxes will also be stored into memory until the memory is full, following with no further incoming fax calls will be automatically answered. To print all data, put fresh paper in the paper tray.

If the MEMORY RECEPTION switch is OFF at this time...

The current fax reception will continue, with the remaining page(s) being stored in memory, subject to available memory. Subsequent incoming fax calls will not be automatically answered until fresh paper is put in the paper tray. To print the last fax received, put paper in the paper tray.

- 1** ▶ Press **Menu, 2, 1, 6**.
- 2** ▶ Use **←** or **→** to select **ON** (or **OFF**), and press **Set** when the screen displays your selection.
- 3** ▶ Press **Stop/Exit**.

Printing a Fax from Memory

If you have fax storage ON for remote retrieval or fax forwarding, you can still print a fax from the machine's memory when you are at the machine: (See *Setting Fax Storage*, page 48.)

- 1** ▶ Press **Menu, 2, 5, 4**.
- 2** ▶ Press **Fax Start**.
- 3** ▶ After all the data saved in the memory is printed out, press **Stop/Exit**.

4 Telephone (Voice) Operation

Making Voice Calls with an External Telephone

If you connect an external telephone to the machine, the machine can be used to make normal telephone calls. You can dial numbers, by using One Touch or Speed Dial memory, Search function or using the dial pad.



You can also use Chain Dialling or Pause function. (See *Chain Dialling*, page 22 and *Pause*, page 23.)



Manual Dialling with an External Telephone

Manual dialling is simply pressing all of the digits of the phone number.

- 1** Pick up the external telephone's handset.
- 2** When you hear a dial tone, dial the number, using the dial pad.
- 3** To hang up, replace the external telephone's handset.

Search

You can search for names you have stored in One Touch and Speed Dial memories. (See *Storing One Touch Dial Numbers*, page 19 and *Storing Speed Dial Numbers*, page 19.)

- 1** Pick up the external telephone's handset.
- 2** Press **Search/Speed Dial**, then enter the first letter of the name you're looking for by using the dial pad.
- 3** Press  or  to search the names that are displayed alphabetically.
- 4** When the screen displays the name you want to call, press **Fax Start** to begin dialling.
- 5** When the call is over, hang up.

One Touch Dialling

- 1 Pick up the external telephone's handset.
- 2 When you hear a dial tone, press the One Touch Dial key of the location you want to call. To use One Touch dial numbers 17-32, hold down **Shift** and press the appropriate One Touch Dial key.
- 3 To hang up, replace the external telephone's handset.



If you try to use a One Touch location with no number stored in it, you hear a warning sound, and screen displays **NOT ASSIGNED**. The display returns to normal after 2 seconds.

Speed Dialling

- 1 Pick up the external telephone's handset.
- 2 When you hear a dial tone, press **Search/Speed Dial**, then press **#** and the three-digit Speed Dial number. (See *Storing Speed Dial Numbers*, page 19.)
- 3 To hang up, replace the external telephone's handset.

On Hook Dialling

- 1 Dial the number by using One Touch, Speed Dial, Search or dial pad.
- 2 The number you are dialling, or the name you have stored for One Touch or Speed Dial is displayed on the LCD.
- 3 Press **Fax Start**.
- 4 Pick up the external telephone's handset and press **Tel** when you hear the caller at other end from the monitor speaker.



When you make a call by pressing **Fax Start** after dialling, you can listen to the other end of the line from the monitor speaker, but they can't hear you unless you pick up the external telephone's handset.

If you accidentally press **Tel** before lifting the external telephone's handset, the call will be disconnected.

Tone/Pulse

If you have pulse dialling service, but need to send tone signals (for telephone banking, for example), follow the directions below. If you have touch tone service, you do not need this feature to send tone signals.

- 1** Lift the external telephone's handset and dial the number.
- 2** When you are asked to enter any number, press **#** on the control panel of the machine. Any digits dialled after this sends tone signals.
- 3** When you hang up, the machine returns to pulse dialling service.

Fax/Tel (F/T) Mode

When you share one line for your telephone and fax machine, in the Fax/Tel (**F/T**) Mode, the machine can determine whether an incoming call is a fax or a telephone call. (See *Select Receive Mode*, page 25.)

Tel Key

This key is used to enter into a telephone conversation having picked up the handset of an external telephone in F/T pseudo-ringing.

Also, if you press **Tel** when you are talking lifting the external telephone's handset with the other end, you can hear the other end from machine's monitor speaker, but the other end cannot hear you.

Transmission Report and Journal Setting

Two reports require initial setup in the Menu table: Transmission Verification Report and Journal Period. For initial setup:

Press **Menu, 2, 4, 1.**

—OR—

Press **Menu, 2, 4, 2.**

1. XMIT REPORT

2. JOURNAL PERIOD

Customizing the Transmission Verification (Xmit) Report

You can use the Xmit Report as confirmation that you sent a fax. This report lists the name or fax number of the receiving party, the time and date of transmission, and if the transmission was successful.

When the feature is **OFF**, the report is printed automatically only if an error occurred during transmission. If the report indicates **ERROR**, send the document again. If the report indicates you should check the readability of certain pages, resend those pages.

If you typically send multiple faxes to the same destinations, you may need a reminder to identify each fax transmission. You can select **OFF+IMAGE** or **ON+IMAGE** to print a portion of the first page of the fax message on the report.

- 1 Press **Menu, 2, 4, 1.**
- 2 Press **←** or **→** to select **OFF**, **OFF+IMAGE**, **ON** and **ON+IMAGE**.
- 3 Press **Set**.
- 4 Press **Stop/Exit**.

Setting the Journal Period

You can set the machine to print activity reports at specific intervals (**EVERY 50 FAXES**, 6, 12, 24 hours, 2, 7 days, or set it to **OFF**). If you set the interval to **OFF**, you can print the report by following the steps in the next section.

- 1 Press **Menu, 2, 4, 2.**
- 2 Press **←** or **→** to choose your setting, and then press **Set**.
- 3 If you choose 7 days, the screen prompts you to choose a day at which to begin the 7-day countdown. Press **←** or **→** to choose your setting and press **Set**.
- 4 Enter the time to begin printing, in 24-hour format (for example, enter 19:45 for 7:45 PM), and press **Set**.
- 5 Press **Stop/Exit**.

Using the Reports Key

Six lists are available.

1 . HELP

Lists basic operational steps and functions.

2 . QUICK-DIAL

Lists names and numbers stored in One Touch Dial or Speed Dial memory, in numerical order.

3 . JOURNAL

Journal lists information about the last 200 incoming and outgoing faxes. TX means Transmit; RX means Receive.

4 . XMIT VERIFY

Prints a Transmission Verification Report for your last transmission.

5 . SYSTEM SETUP



Lists settings for **GENERAL SETUP**, **SETUP RECEIVE**, **SETUP SEND**, **REPORT SETTING**, **REMOTE FAX OPT** and **MISCELLANEOUS**.

6 . ORDER FORM

You can print an accessories order form to your Brother dealer for service.

To Print a Report

1 Press **Reports**.

2 Press  or  to select the report you want, and then press **Set**.

—OR—

Enter the number of the report you want to print. For example, press **1** to print the Help List.

Advanced Operations

Electronic Cover Page

The cover page is sent to the receiving party's machine. Your cover page includes the name stored in the One Touch or Speed Dial memory, if you have used this feature to start the call.

The cover page indicates the fax is from your Station ID, and the number of pages you're sending. If you have **COVERPG SETUP** set to **ON** (see *Always Send Cover Page*, page 36), the number of pages on the cover page remains blank.

You can select a comment to include on your cover page, or you can select **1.NOTE OFF** if you do not wish to include a comment.

As well as using one of the comments shown on the right, you can also enter up to two customized messages, each 27 characters long. (See *Composing Your Own Comments*, page 36.)

1. NOTE OFF
SELECT ← → & SET

2. PLEASE CALL
SELECT ← → & SET





3. URGENT
SELECT ← → & SET

4. CONFIDENTIAL
SELECT ← → & SET

Cover Page for Next Fax Only

Make sure Station ID is set up. (See *Setting the Station ID*, page 14.) This feature does not work without the Station ID.





You can set the machine to send a cover page with a particular document. This cover page will include the number of pages in your document.

- 1 Insert the document face down in the ADF.
- 2 Press **Menu, 2, 2, 7**.
- 3 Press **Set** when the screen displays **NEXT FAX ONLY**.
- 4 Press  or  to select **ON**, and press **Set**.
- 5 Press  or  to view the comment selections.
- 6 Press **Set** when the screen displays your selection.
- 7 Enter two digits to indicate the number of pages you are sending. (Enter 00 to leave the number of pages blank.) If you make a mistake, press  to back up and re-enter the number of pages.
- 8 Press **Set**. The screen prompts you to continue.
- 9 Press **1** if you want to select additional settings. The display returns to the **SETUP SEND** menu—**OR**—Press **2** if you are finished choosing settings, and go to Step 10.
- 10 Enter the fax number and then press **Fax Start**.

Always Send Cover Page



Make sure Station ID is set up. (See *Setting the Station ID*, page 14.) This feature does not work without the Station ID.

You can set the machine to send a cover page whenever you send a fax. The number of pages in your fax is not included when you use this setting.



- 1 Press **Menu, 2, 2, 7**.
- 2 Press  or  to select **COVERPAGE:ON** or **(OFF)**.
- 3 Press **Set**. (If you select **ON**, a coverpage is always sent when you send a fax.)
- 4 If you selected **ON**, the screen displays the cover page comment options. Press  or  to view comment selections.
- 5 Press **Set** when the screen displays your selection. The screen prompts you to continue.
- 6 Press **1** if you want to select additional settings. The display returns to the **SETUP SEND** menu—**OR**—Press **2** to exit if you are finished choosing settings.

Using a Printed Cover Page

If you prefer using a printed cover page that you can write on, you can print the sample page and attach it to your fax.

- 1 Press **Menu, 2, 2, 7**.
- 2 Press  or  to select **PRINT SAMPLE**, and press **Set** when the screen displays your selection.
- 3 Press **Fax Start**. The machine prints a copy of your cover page.
- 4 Press **Stop/Exit**.

Composing Your Own Comments

- 1 Press **Menu, 2, 2, 8**. The screen displays: **COVERPAGE NOTE**.
- 2 Use  or  to choose position 5 or 6 for your customized comment, and press **Set**.
- 3 Use the dial pad to enter your customized comment (up to 27 characters.) (See *Entering Text*, page 94.)
- 4 Press **Set**. The screen prompts you to continue.
- 5 Press **1** if you want to select additional settings. The display returns to the **SETUP SEND** menu—**OR**—Press **2** to exit.

Overseas Mode

Sometimes, when sending a fax to overseas numbers, problems can be experienced. This mode makes the machine work better for such calls.

After you send a fax using this feature, the feature turns itself off.

- 1 Insert the document face down in the ADF.
- 2 Press **Menu, 2, 2, 9**.
- 3 Press **←** or **→** to select **ON** (or **OFF**), and press **Set** when the screen displays your selection.
- 4 Press **1** if you want to select additional settings. The display returns to the **SETUP SEND** menu—**OR**—Press **2** if you are finished choosing settings and go to Step 5.
- 5 Enter the fax number you're calling, and press **Fax Start**.

Delayed Transmission (Timer)

You can use this function to send a fax up to 24 hours later.

- 1 Insert the document face down in the ADF.
- 2 Press **Menu, 2, 2, 3**.
- 3 Enter the time you want the fax to be sent, in 24-hour format (for example, enter 19:45 for 7:45 PM), and press **Set**.
- 4 Press **1** to select **DOC**—**OR**—Press **2** to select **MEMORY**. If you select **1.DOC**, the machine will not start scanning the document until the preset time. The document must be left in the ADF. If you select **2.MEMORY** the machine will scan and store the document and the ADF is free for copying or faxing further documents.
- 5 Press **1** if you want to select additional settings. The display returns to the **SETUP SEND** menu—**OR**—Press **2** if you are finished choosing settings and go to Step 6. The screen prompts you to enter the fax number.
- 6 Enter the fax number, and press **Fax Start**. The machine will wait until the time you have entered to send the fax.

Delayed Batch Transmission

Before sending the delayed faxes, your Brother machine will economize by sorting all the documents in memory by destination and scheduled time. If you set Batch Transmission to ON, all delayed faxes scheduled at the same time to the same fax number will be sent as one transmission.

- 1 Press **Menu, 2, 2, 4**.
- 2 Press **←** or **→** to select **ON** (or **OFF**) and press **Set**.
- 3 Press **Stop/Exit**.

Broadcasting

Broadcasting is automatically sending the same fax message to multiple fax numbers. Using the **Broadcast** key, you can include up to 32 One Touch locations, up to 200 Speed Dial locations, and up to 50 manually dialled numbers (maximum of 282 locations if you did not use up any locations for Groups, access codes or credit card numbers). However, available memory will vary with the types of jobs in memory and numbers of locations used for broadcasting. If you broadcast to more than the maximum locations available, you will not be able to setup transmissions using dual access and the timer.

The easiest way to broadcast is to first combine frequently used One Touch and Speed Dial numbers as a Group, which uses up a One Touch key or a Speed Dial #. (Remember, you can have up to six Groups and Quick Dial numbers can be included in more than one Group). Then by pressing **Broadcast** between each location, you can include One Touch, Speed Dial, Groups, and manual dialling (using the dial pad) in the same broadcast. Use **Search/Speed Dial** to help you choose the numbers easily.

After the broadcast is completed, a Broadcast Report will be printed automatically to let you know the results.

- 1** Insert the document face down in the ADF.
- 2** Enter a number using One Touch, Speed Dial, Search, Group number or the dial pad.
Example: Group number
- 3** Press **Broadcast**. You will be prompted to enter the next number.
- 4** Enter the next number.
Example: Speed Dial
- 5** Press **Broadcast**.
- 6** Enter the next fax number.
Example: Manual dialling, using the dial pad.
- 7** Press **Fax Start**.

The machine will read the documents into memory and then start sending faxes to all the numbers you entered.



- To skip one of the locations in broadcasting, press **Stop/Exit** whilst that number is being dialled. To cancel all locations, press **Menu, 2, 6**. The locations, which were cancelled, are printed on the Broadcast Report.
- Enter the long dialling sequence numbers as you normally would, but keep in mind that each key counts as one location, so the number of locations you can call becomes limited.
- If the line is busy or a connection could not be made for some other reasons while broadcasting, the machine will redial the number automatically.
- If the memory is full, press **Stop/Exit** to abort the job or press **Fax Start** to send the portion that is in the memory (if more than one page has been scanned).

Setting Up Groups for Broadcasting

Groups allow you to send the same fax message to many fax numbers by pressing only one One Touch key. (This is called Broadcasting.) **First**, you will need to store each fax number as a One Touch or Speed Dial number. (See *Storing One Touch Dial Numbers*, page 19. Also see *Storing Speed Dial Numbers*, page 19.) **Then**, you can combine them into a Group. Each Group uses up a One Touch key. Finally, you can have up to 6 small Groups, or you can assign up to 231 numbers to one large Group.

1 Press **Menu, 2, 3, 3**.

PRESS SPEED-DIAL
OR ONE-TOUCH KEY

2 Select a One Touch or Speed Dial key where you wish to store the number. (For example, press One Touch key **02** to use as a Group.)

SETUP GROUP:GO
ENTER & SET KEY

3 Use the dial pad to enter the Group number, and then press **Set**.
(For example, press **1** for Group 1.)

4 To include One Touch or Speed Dial numbers in the Group, enter them as if you were dialling. For example, for One Touch Dial key **05**, press **One Touch Dial key 05**. For Speed Dial location 009, press **Search/Speed Dial**, then press **0, 0, 9** on the dial pad. The LCD shows *005, #009.

G01:*005#009_
ENTER & SET KEY

5 Press **Set**. The screen prompts you to enter a name.

6 Use the dial pad to enter a name for the group (for example, NEW CLIENTS) and press **Set**.
(See *Entering Text*, page 94.)

7 Press **Stop/Exit**.



You can print a list of all One Touch and Speed Dial numbers. Group numbers will be marked in the column of "GROUP". (See *Printing Reports*, page 33.)



Cancelling a Job While Scanning the Document

You can cancel a job while you are scanning it into memory by pressing **Stop/Exit**. Eject the document by pressing **Stop/Exit** again.

Checking and Cancelling a Scheduled Job in Memory

You can check or cancel a job that is waiting in memory.

If the machine is idle,

- 1** Press **Menu, 2, 6**.
Any waiting jobs appear on the display. If nothing is waiting, the screen displays **NO JOB WAITING**.
- 2** If you have more than one job waiting, use  or  to select the job you want to cancel. Press **Set** when the screen displays your selection—**OR**—If you have only one job waiting, go to Step 3.
- 3** Press **1** to cancel—**OR**—Press **2** to exit without cancelling.
To cancel another job, return to Step 2.
- 4** Press **Stop/Exit**.



You can check which jobs are remaining in memory by following Steps 1 and 2 above.

Memory Security

This feature allows you to prevent unauthorised access to the machine. When switched ON, Memory Security prohibits most functions. The following functions listed are available while Memory Security is switched ON.

- Receiving faxes into memory [limited by Memory Capacity].
- Scheduled Delayed Transmission*
- Polling*
- Fax Forwarding*
- Remote Retrieval

* Provided it was set before Memory Security was switched ON.

Using Memory Security

You need to use a password to switch Memory Security **ON** and **OFF**.

Setting Up Memory Security for the First Time

1 Press **Menu, 2, 0, 1**.

NEW PASSWD:XXXX
ENTER & SET KEY

2 Enter a 4-digit number as a password.

3 Press **Set**.

The screen prompts you to re-enter the password.

VERIFY:XXXX
ENTER & SET KEY

4 Re-enter the password and press **Set**.

5 Press **←** or **→** to choose **SET SECURITY**.

6 Press **Set**.

The screen prompts you to enter the password.

PASSWORD:XXXX
ENTER & SET KEY

7 Enter a 4-digit password, followed by **Set**.

This is the same as the security password of the machine already stored.

The screen displays **ACCEPTED** for 2 seconds, followed by **SECURE MODE** - Memory Security is now switched ON.



If the password you enter at Step 7 is incorrect, the screen would display **WRONG PASSWORD**. After 2 seconds the display will then return to normal (displaying the date & time). You must then switch ON Memory Security again. (See *Switching Memory Security ON*, page 42.)

Changing the Memory Security Password

1 Press **Menu, 2, 0, 1**.

2 Press **←** or **→** to choose **SET PASSWORD**.

3 Press **Set**.

The screen prompts you to enter the old password.

OLD PASSWD:XXXX
ENTER & SET KEY

4 Enter the current password.

5 Press **Set**.

NEW PASSWD:XXXX
ENTER & SET KEY

6 Enter a 4-digit number as a new password.

7 Press **Set**.



The screen prompts you to re-enter the new password.

VERIFY:XXXX
ENTER & SET KEY

8 Enter the new password again and press **Set**.

9 Press **Stop/Exit**.

Switching Memory Security ON

- 1 Press **Menu**, **2**, **0**, **1**.
- 2 Press  or  to choose **SET SECURITY**.
- 3 Press **Set**.
The screen prompts you to enter the password.
- 4 Enter a 4-digit password, followed by **Set**.

This is the same as the security password of the machine already stored.

PASSWORD:XXXX
ENTER & SET KEY

The screen displays **ACCEPTED** for 2 seconds, followed by **SECURE MODE** - Memory Security is now switched ON.



If the password you enter at Step 4 is incorrect, the screen would display **WRONG PASSWORD**. After 2 seconds the display will then return to normal (displaying the date & time). You must then start from Step 1 to set Memory Security.

Switching OFF Memory Security

- 1 When Memory Security is switched ON, press **Menu**.
- 2 Enter a 4-digit password and press **Set**.

PASSWORD:XXXX
ENTER & SET KEY

The screen displays **ACCEPTED**, then after 2 seconds the display reverts to normal. Memory Security is now switched OFF. Then all the data saved in the memory will be printed out.



If the password you enter at Step 2 is incorrect, the screen would display **WRONG PASSWORD**. After 2 seconds the display will then return to displaying **SECURE MODE**. You must then start from Step 1 to switch OFF Memory Security.

If you forget the Memory Security password, please contact your Brother dealer for service or the help number given with the warranty documentation.

Operation from an External or Extension Telephone

An external phone is a telephone that is plugged into the machine (either into the machine's EXT socket or into the back of the connector that plugs into the telephone wall socket).

An extension phone is another phone on the same phone number as the machine, but plugged into a different telephone wall socket. For example, the machine may be connected to a phone line in your study, and you may have another phone on the same line (and same phone number) in your kitchen. This feature enables you to answer the phone in the kitchen if it rings while you are making a coffee, knowing that you can transfer the call to the machine if the incoming call is a fax.

If you answer a fax call on an external or extension phone, you can make the machine take over by using the Activation Code. When you press the Activation Code * 5 1, the machine starts to receive a fax. If you set **FAX DETECT** to **ON**, you don't have to press * 5 1, just hold the handset and wait for several seconds. (See *Fax Detect (with an External or Extension Telephone)*, page 27.)

If the machine answers a voice call and F/T pseudo-rings for you to take over, use the Deactivation Code # 5 1 to take the call at an extension phone. (You have to set Remote Activation to **ON** in **Menu, 2, 1, 4** to use * 5 1 or # 5 1.)

If you answer a call, and no one is on the line, assume you are receiving a fax. At an extension phone, press * 5 1, wait for fax receiving tones (chirps), then hang up. At an external phone, press * 5 1 and wait for the phone to be disconnected (the screen displays **RECEIVING**) before you hang up. (Your caller will have to press Start to send the fax.)



If you accidentally pick up an extension phone when a fax message is being received, you may disrupt the transmission or render some portions unreadable.



* 5 1—From an extension phone, or an external phone, * 5 1 will set the machine in receive mode.

5 1—From an extension phone, # 5 1 can stop the machine receiving. This is effective in F/T and Fax Detect modes.

The Remote Activation Code can also be used by your callers. When you are using an external TAD, your outgoing message (OGM) should end with the statement "to send a fax, press * 5 1". (See *Outgoing Message (OGM) of External TAD*, page 7.)

For Fax/Tel Mode Only

When the machine is in Fax/Tel (F/T) Mode, it will use the F/T Ring Time (F/T pseudo-ringing*) to alert you to a voice call. If you're at the machine, you can lift the external telephone's handset and press **Tel** to answer.

If you're at an extension phone, you will need to lift the handset during the F/T Ring Time and press # 5 1 between the F/T pseudo-rings. If no one is on the line, or if someone wants to send you a fax, send the call back to the machine by pressing * 5 1.

* pseudo-ringing is a ring tone produced by the machine. The sender's telephone line is connected to the machine at this moment.



Switching ON Remote Activation and Changing Remote Codes

Remote Codes might not work with some telephone systems. The preset Activation Code is * 5 1. The preset Deactivation Code is # 5 1.



If you are always disconnected when accessing your external TAD remotely, try changing the Activation Code from * 5 1 to ### and the Deactivation Code from # 5 1 to 1 1 1. You cannot use the same number for the Activation Code, the Deactivation Code and the Remote Access Code.

To switch Remote Activation ON and change Remote Codes

- 1 Press **Menu**, **2**, **1**, **4**.
- 2 Press  or  to select **ON** (or **OFF**), and press **Set** when the screen displays the setting you want.
- 3 If you want to, enter a new Remote Activation Code, then press **Set**.
- 4 If you want to, enter a new Remote Deactivation Code, then press **Set**.
- 5 Press **Stop/Exit**.

Telephone Services

BT Call Sign (For U.K. Only)



This machine feature lets you use the BT Call Sign subscriber service which allows you to have at least two separate telephone numbers on one phone line. Each phone number has its own distinctive ringing pattern, so you know which phone number is ringing. This is one way you can have a separate phone number for the machine.

The machine has a BT Call Sign compatible distinctive ringing function, allowing you to dedicate a second phone number (on the same phone line) just for receiving faxes.



- To have your external TAD answer only the main number, the machine must be in **Manual Mode**.
- In **FAX/TEL (F/T)** or **FAX ONLY** mode, the machine will answer all numbers on the phone line.

To enable the machine to work with BT Call Sign

- 1 Set the machine to **MANUAL** mode by pressing **Mode**.
- 2 Press **Menu**, **2**, **0**, **4**. The screen displays the current setting of this feature.
- 3 Press  or  to select **ON**.
- 4 Press **Set**.
- 5 Press **Stop/Exit**.



Polling is the process of retrieving faxes from another machine. You can use the machine to “poll” other machines, or you can have someone poll the machine.

All parties involved in polling need to set up their machines to accommodate polling. When someone polls the machine to receive a fax, they pay for the call; if you poll someone’s fax machine to receive a fax, you pay for the call. (See *Polling Transmit*, page 47.)



Some machines do not respond to the polling function.

Secure Polling

Secure Polling is a way to keep your documents and others’ from falling into the wrong hands while the fax machines are set up for polling. You can use Secure Polling only with another Brother fax machine. Anyone who polls to receive a fax must enter the polling secure code.

Polling Receive

Polling Receive is when you call another fax machine to receive a fax from it.

Setup for Polling Receive (Standard)

- 1 Press **Menu, 2, 1, 8**.
- 2 Press or to choose **STANDARD**, and press **Set**.
- 3 Enter the fax number you are polling, and press **Fax Start**.

The screen displays **DIALING #XXX**.

ENTER FAX NO.
 PRESS FAX START

Setup for Polling Receive with Secure Code



You need to make sure you are using the same secure code as the other party.

- 1 Press **Menu, 2, 1, 8**.
- 2 Press or to choose **SECURE**, and press **Set**.
- 3 Enter a four-digit secure code.
This is the same as the security code of the fax machine you are polling.
- 4 Press **Set**.
- 5 Enter the fax number you are polling.
- 6 Press **Fax Start**.

ENTER FAX NO.
 PRESS FAX START

Setup Delayed Polling Receive

You can set the machine to begin Polling Receive at a later time.

- 1** Press **Menu, 2, 1, 8**.
- 2** Press  or  to choose **TIMER**, and press **Set**.
- 3** The screen prompts you to enter the time you want to begin polling.
- 4** Enter the time (in 24-hour format) you want to begin polling.
For example, enter 21:45 for 9:45 PM.
- 5** Press **Set**. The screen prompts you to enter the fax number you are polling.
- 6** Enter the fax number, and press **Fax Start**.
The machine makes the polling call at the time you entered.



ENTER FAX NO.
PRESS FAX START



You can set up only one Delayed Polling.

Sequential Polling

The machine can request documents from several fax units in a single operation. You just specify several destinations in Step 4. Afterwards, a Sequential Polling Report will be printed.

- 1** Press **Menu, 2, 1, 8**.
- 2** Press  or  to choose **STANDARD**, **SECURE** or **TIMER**, and press **Set** when the screen displays the setting you want.
- 3** If you selected **STANDARD**, go to Step 4.
 - If you selected **SECURE**, enter a four-digit number and press **Set**, and then go to Step 4.
 - If you selected **TIMER**, enter the time (in 24-hour format) you want to begin polling and press **Set**, and then go to Step 4.
- 4** Specify the destination fax machines (up to 282), which you wish to poll by using One Touch, Speed Dial, Search, a Group or the dial pad. You must press **Broadcast** between each location.
- 5** Press **Fax Start**.
The machine polls each number or group number in turn for a document.

Polling Transmit

Polling Transmit is when you set up the machine to wait with a document so another fax machine can retrieve it.



The document will be stored and can be retrieved from any other fax machine until you delete the fax in memory by using the Cancelling a Job function. (See *Checking and Cancelling a Scheduled Job in Memory*, page 40.)

Setup for Polling Transmit (Standard)

- 1 Insert the document face down in the ADF.
- 2 Press **Menu, 2, 2, 6**.
- 3 Press or to choose **STANDARD**, and press **Set**. The screen displays
- 4 Press **1** to select **DOC** if you want the machine to scan the printed document at the time it is polled—**OR**—Press **2** to select **MEMORY**.
- 5 Press **1** if you want to select additional settings. The display returns to the **SETUP SEND** menu—**OR**—Press **2** to exit if you are finished choosing settings.
- 6 Press **Fax Start** and wait for the fax to be polled.

Setup for Polling Transmit with Secure Code

When you choose **POLLING:SECURE**, anyone who polls the machine must enter the polling secure code.



- 1 Insert the document face down in the ADF.
- 2 Press **Menu, 2, 2, 6**.
- 3 Press or to choose **SECURE**, and then press **Set**.
- 4 Enter a four-digit number, and press **Set**. The screen displays
- 5 Press **1** to select **DOC** if you want the machine to scan the printed document at the time it is polled—**OR**—Press **2** to select **MEMORY**.
- 6 Press **1** if you want to select additional settings. The display returns to the **SETUP SEND** menu—**OR**—Press **2** to exit if you are finished choosing settings.
- 7 Press **Fax Start** and wait for the fax to be polled.



You can use Secure Polling only with another Brother fax machine.

Setting Fax Storage

If you set Fax Storage to **ON**, you will be able to retrieve fax messages from another location, using Fax Forwarding or Remote Retrieval functions. The screen will indicate when you have a fax stored in memory.

- 1 Press **Menu, 2, 5, 2**.
- 2 Press  or  to select **ON** (or **OFF**), and press **Set** when the screen displays your selection.
- 3 Press **Stop/Exit**.





If there are faxes in memory when you turn the Fax Storage **OFF**, the screen prompts you to erase any faxes in memory.

If you press **1**, all fax data is erased and Fax Storage is turned **OFF**. If the fax data in memory has not been printed before, it will be printed first, and then erased. If you press **2**, data is not erased, and Fax Storage remains **ON**.

Backup Print

If you have set **FAX STORAGE** to **ON**, your faxes will be received into memory, so you can retrieve them remotely. With **BACKUP PRINT** set to **ON**, the machine automatically prints faxes as they are received into memory. You can turn Backup Print **OFF** to save paper or prevent confidential documents from printing in your absence.

- 1 Press **Menu, 2, 5, 5**.
- 2 Press  or  to select **ON** (or **OFF**), and press **Set** when the screen displays your selection.
- 3 Press **Stop/Exit**.



Fax Forwarding



You cannot use Fax Forwarding when “Fax Storage” is set to **OFF**.

Programming a Fax Forwarding Number

When Fax Forwarding and Fax Storage are set to **ON**, the machine stores the received fax in memory, then dials the fax machine phone number you’ve programmed, and forwards the fax message.

- 1 Press **Menu, 2, 5, 1**.
- 2 Press  or  to select **ON** (or **OFF**), and press **Set**.
The screen prompts you to enter the number of the fax machine where faxes will be forwarded.

3 Enter the forwarding number (up to 20 digits), and press **Set**.

4 Press **Stop/Exit**.



You can also dial into the machine from a remote location to switch this feature on, or to change the number you want your faxes forwarding to. (See *Changing the Fax Forwarding Number*, page 51.)

Changing the Remote Access Code

Enter your Remote Access Code when the machine picks up your call, so you can access features remotely. The access code is preset to **1 5 9 ***, but you can change this.

1 Press **Menu, 2, 5, 3**.

2 Enter a three-digit code using number keys 0-9, ***** and **#**, and press **Set**.

The fourth digit ***** cannot be changed. Do not use the same digits that appear in your Remote Activation or Deactivation Code.

3 Press **Stop/Exit**.

Remote Retrieval

Using Your Remote Access Code

To receive faxes at your location, you must call from a fax machine using touch tone. For convenience, you can retrieve faxes from a touch tone phone by having them sent to a fax machine. For example, if your hotel room does not have a fax machine, you can enter the number of the fax machine at the hotel's Front Desk.

1 Dial your fax number from a touch tone phone.

2 When the machine answers and beeps, immediately enter your Remote Access Code (the factory setting is **1 5 9 ***).

3 The machine signals the kinds of messages received:

1 long beep — Fax message(s)

No long beep — No messages

4 The machine prompts you with two short beeps to enter a command. If you wait longer than 30 seconds to enter a command, the machine hangs up. If you enter an invalid command, the machine beeps three times.

5 Press **9 0** when you finish.

6 Hang up.

Remote Commands

Follow the commands below to access features remotely. When you call the machine and enter your Remote Access Code (the factory setting is **1 5 9 ***), the system will signal you with two short beeps to enter a remote control command.

Change Fax Forwarding Setting

Press **9 5**

then to

Turn Fax Forwarding OFF—Press **1**.

Turn Fax Forwarding ON—Press **2**.

Program Fax Forward Number—Press **4**. Automatically turns Fax Forwarding **ON**.

Turn Fax Storage ON—Press **6**.

Turn Fax Storage OFF—Press **7**. (This is only possible if there are no faxes stored in the memory, or if all faxes have been erased using Remote Control **9 6 3**).

Retrieve or Erase a Fax

Press **9 6**

then to

Retrieve all faxes—Press **2**, then enter the number of remote fax machine and then press **# #**. After the beep, hang up and wait.

Erase all fax messages—Press **3**. If the data stored in the memory has not been printed before, it will be printed first and then erased.

Check the Receiving Status

Press **9 7**

then Press 1.

1 long beep—Received fax messages.

3 short beeps—No messages.

Change Receive Mode

Press **9 8**

then for

TAD—Press **1**.

F/T (FAX/TEL)—Press **2**.

FAX—Press **3**.

Exit Remote Operation

Press **9 0**

Retrieving Fax Messages

- 1 Dial the machine's number.
- 2 When you hear the beep, immediately enter your Remote Access Code (the factory setting is **1 5 9 ***).
- 3 As soon as you hear two short beeps, use the dial pad to press **9 6 2**.
- 4 Using the dial pad, enter the number (up to 20 digits) of the remote fax machine where you want your fax messages forwarded, and then press **# #**.



You cannot use * and # as dial numbers. However, if you want to store a pause, press #.

- 5 After you hear the machine beep, hang up and wait.
The machine calls the remote fax machine and sends the stored documents. The remote fax machine prints your fax messages.

Changing the Fax Forwarding Number

You can change the default setting of your fax forwarding number from a remote telephone/fax machine using touch tone.

- 1 Dial the machine's number.
- 2 When you hear the beep, immediately enter your Remote Access Code (the factory setting is **1 5 9 ***).
- 3 When you hear two short beeps, use the dial pad to press **9 5 4**.
- 4 Enter the new number of the remote fax machine where you want your fax messages forwarded, and then press **# #**.



You cannot use * and # as dial numbers. However, if you want to store a pause, press #. Also, if the machine is connected to a PABX, you can press # first before the fax machine's number. The # works as well as **R** key.

- 5 After you hear the machine beep, hang up.

10 Making Copies

Basic Copy Operations

Using The Machine as a Copier

You can use the machine as a copy machine, making up to 99 copies at a time.

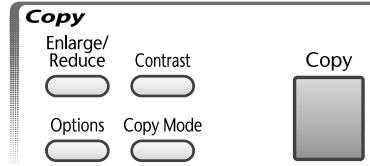

Do NOT pull on the paper while copying is in progress. To cancel, press Stop/Exit. Press Stop/Exit again to release the original document.

The scannable area of the machine begins at approximately 4 mm from the edge of the paper.

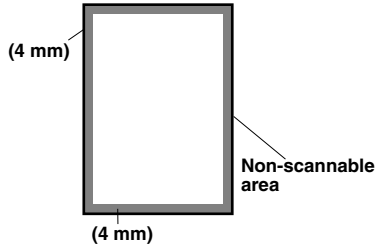

Making a Single Copy

- 1 Insert the document face down in the ADF.
- 2 Press **Copy**.



To stop, press **Stop/Exit**. To release the original document, press **Stop/Exit** again.

Making Multiple Copies

- 1 Insert the document face down in the ADF.
- 2 Using the dial pad, enter the number of copies you want (up to 99).
For example, press **3, 8** for 38 copies.
- 3 Press **Copy**.



To sort the copies, use **Options** key. (See *Sorting Multiple Copies*, page 55.)

Out of Memory Message

If you get an **OUT OF MEMORY** message while scanning the first page to be copied, press **Stop/Exit** to cancel the operation and restart to make a single copy. If you get an **OUT OF MEMORY** message while scanning in a subsequent page, you will have the option to press **Copy** to copy the pages scanned so far—**OR**—Press **Stop/Exit** to cancel.

You will need to clear some fax messages to make some additional memory available before you can continue.



To gain extra memory, you can turn off Fax Storage—**OR**—Print fax messages in memory (See *Setting Fax Storage*, page 48.)—**OR**—Expand the machines memory.

Temporary Copy Setting

You can quickly enlarge or reduce copies or improve the copy quality by using the **Enlarge/Reduce**, **Contrast**, **Copy Mode** and **Options** keys. These settings are temporary, and the machine returns to its default settings when you finish copying.

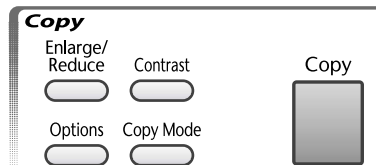

Copying Using Multiple Settings

You can try different combinations of settings for the best results.

After you finish settings using the **Enlarge/Reduce**, **Contrast**, **Copy Mode** or **Options** keys the LCD shows:

PRESS COPY OR
←→ FOR NEXT OPT.

- Press or if you want to select additional settings.
—**OR**—
Press **Copy** if you are finished choosing settings.

Making Enlarged or Reduced Copies

- 1 Insert the document face down in the ADF.
- 2 Using the dial pad, enter the number of copies you want (up to 99).
- 3 Press **Enlarge/Reduce**.
- 4 Press \leftarrow or \rightarrow to select **50%**, **71%**, **100%**, **141%**, **150%** or **200%**.
—OR—
You can press \leftarrow or \rightarrow to select **MANUAL** and use the dial pad to enter an enlargement or reduction ratio between **50%** and **200%**. For example, press **5, 3** to enter **53%**.
- 5 Press **Set**.
- 6 Press **Copy**—OR—Press \leftarrow or \rightarrow for additional settings.

Selecting Recommended Ratio

A4	→	A5	71%
A5	→	A6	
B5	→	B6	
A5	→	A4	141%
A6	→	A5	
B6	→	B5	



Special Copy Options (2 in 1 or 4 in 1 copy) are not available with **Enlarge/Reduce**.

Using the Contrast Key



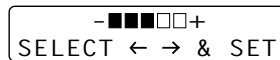

You can choose the brightness setting before making a copy.

- 1 Insert the document face down in the ADF.
- 2 Using the dial pad, enter the number of copies you want (up to 99).
- 3 Press **Contrast**.
- 4 Press \leftarrow to make a lighter copy.
—OR—
Press \rightarrow to make a darker copy.
- 5 Press **Set**.
- 6 Press **Copy**—OR—Press \leftarrow or \rightarrow for additional settings.



Using the Copy Mode Key

You can select the Copy resolution for your type of the original document (**TEXT**, **AUTO** or **PHOTO**). Select the right kind of image you are copying.

- 1 Insert the document face down in the ADF.
- 2 Using the dial pad, enter the number of copies you want (up to 99).
- 3 Press **Copy Mode**.
TEXT (text only)
AUTO (line art, graphs, or any combination including photograph)
PHOTO (photograph only)
- 4 Press  or  to select the right kind of image you're copying, and press **Set**.
- 5 Press **Copy**—OR—Press  or  for additional settings.

Using the Options Key







The **Options** key changes the settings for number of copies, stack/sort, special copy and paper type options **for the next copy only**.

Press **Options**.

Press Options	Menu Selections	Options	Factory Setting
	NO. OF COPIES	NO. OF COPIES:XX	01
	STACK/SORT	STACK/SORT	STACK
	SPECIAL	2 IN 1/4 IN 1/OFF	OFF
	PAPER TYPE	THIN/PLAIN/THICK/ THICKER/ TRANSPARENCY	PLAIN







Sorting Multiple Copies

Sorting uses more memory than Stacking, as the whole document is scanned into memory to start with.

- 1 Insert the document face down in the ADF.
- 2 Using the dial pad, enter the number of copies you want (up to 99).
- 3 Press **Options** and  or  to select **STACK/SORT**, and then press **Set**.
- 4 Press  or  to select **SORT**, and then press **Set**.
- 5 Press **Copy**—OR—Press  or  for additional settings.

Special Copy Options

You can save paper by copying either two or four pages onto one page.

- 1 Insert the document face down in the ADF.
- 2 Using the dial pad, enter the number of copies you want (up to 99).
- 3 Press **Options** and  or  to select **SPECIAL**, and then press **Set**.
- 4 Press  or  to select **2 IN 1**, **4 IN 1** or **OFF**, and then press **Set**.
- 5 Press **Copy—OR—**Press  or  for additional settings.

2 in 1

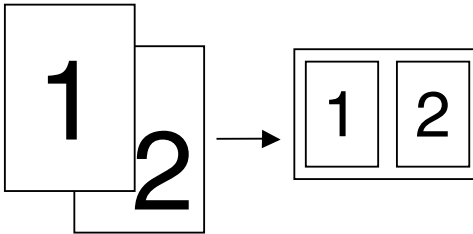

4 in 1

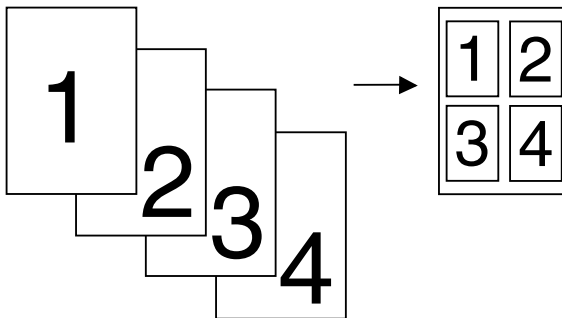







Special Copy Options (2in1 or 4in1 Copy) are not available with **Enlarge/Reduce**.

Paper Type

You can use the following types of paper for copying. For the best print quality, select the type of media that you are using. (See *Acceptable Paper*, page 92.)



THIN (60-69 g/m ²)	For thin paper
PLAIN (70-95 g/m ²)	For ordinary plain paper
THICK (96-120 g/m ²)	For heavy weight paper or rough paper
THICKER (121-161 g/m ²)	For heavier weight paper, rough paper or bond paper
TRANSPARENCY	For transparency (OHP)

- 1 Press **Options** and  or  to select **PAPER TYPE**, and then press **Set**.
- 2 Press  or  to select your type of paper, and then press **Set**.
- 3 Press **Copy**—OR—Press  or  for additional settings.

Copy Quality – Default Settings

Changing Default Settings

Press **Menu, 3** to change default settings for Copy mode. These settings will remain until you change them again by pressing **Menu**. Adjust the Copy Mode, Contrast and Paper Type settings.

By pressing a number, you can adjust copy settings as shown in the following chart. Press  or  to move through the selections for each setting. Press **Set** to save your selection. Press **Stop/Exit**—OR—Press  to select the next setting you want to change.

Press **Menu**, and **3**.

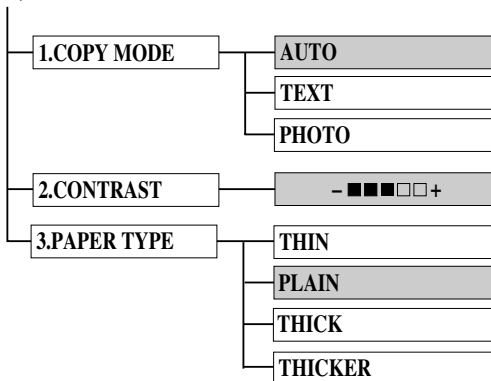

 is default

Copy Mode (Type of Original)

You can select the Copy resolution for your type of original. The default setting is **AUTO**, which is used for originals that contain both text and photographs. **TEXT** is used for originals containing only text. **PHOTO** is used for copying photographs.

- 1 Press **Menu, 3, 1**.
- 2 Press \leftarrow or \rightarrow to choose the type of original (**AUTO**, **TEXT** or **PHOTO**), and then press **Set**.
- 3 Press **Stop/Exit—OR—**Press \leftarrow or \rightarrow for additional settings.

Copy Contrast

You can adjust copy contrast to make copies darker or lighter.

- 1 Press **Menu, 3, 2**.
- 2 Press \leftarrow to make a copy lighter—**OR—**Press \rightarrow to make a copy darker, and then press **Set**.
- 3 Press **Stop/Exit—OR—**Press \leftarrow or \rightarrow for additional settings.

Paper Type

You can use the following types of paper for copying. For the best print quality, select the type of media that you use most often.

- | | |
|--|---|
| THIN (60-69 g/m ²) | For thin paper or transparency |
| PLAIN (70-95 g/m ²) | For ordinary plain paper |
| THICK (96-120 g/m ²) | For heavy weight paper or rough paper |
| THICKER (121-161 g/m ²) | For heavier weight paper, rough paper or bond paper |

- 1 Press **Menu, 3, 3**.
- 2 Press \leftarrow or \rightarrow to select your type of paper, and then press **Set**.
- 3 Press **Stop/Exit**.

Manual Feed Slot

The machine has a manual feed slot above the paper tray. You can load envelopes and special print media one at a time into this slot. You do not have to remove paper from the paper tray. (See *Acceptable Paper*, page 92.)

Use the manual feed slot to copy on labels, envelopes, organizer paper, card stock or thicker paper. (See *Copying onto Thicker Paper and Card Stock*, page 59.)



If you use transparencies, labels and envelopes, they must be of a type suitable for use with a laser printer. If you use incorrect types it is possible to damage or contaminate the drum surface and cause problems.

Loading Paper

Insert a sheet of paper with the side you wish to print on face up in the manual feed slot.

- 1 Align the paper at the centre of the manual feed slot, and be sure to insert the paper into the manual feed slot until the front edge of the paper touches the paper feed roller.
- 2 Adjust the paper guide of the manual feed slot to the width of the paper you're using.

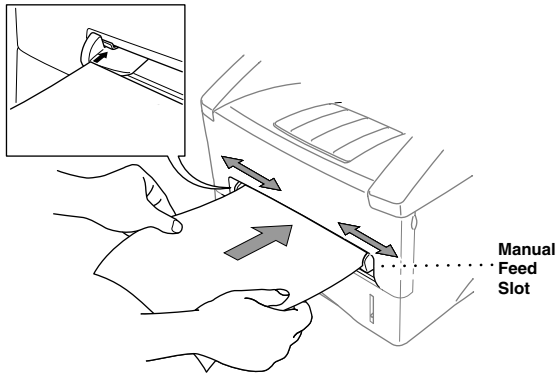

Copying onto Thicker Paper and Card Stock

When the rear cover is opened, the machine has a straight paper path from the manual feed slot to the rear of the printer. Use this paper feed and output method when you want to print on envelopes, thicker paper or card stock.

- 1 Open the rear cover of the machine.

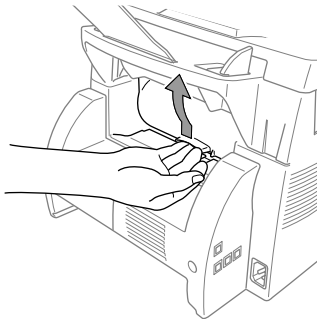

- 2 Adjust the manual feed paper guides to the width of the paper you are using.
- 3 Insert a single sheet of paper into the manual feed slot until the front edge touches the paper feed rollers. Let go of the paper as the machine pulls it into position.
- 4 After the machine ejects the printed page, return to Step 3 to insert the next sheet of paper. The machine will wait until you insert the next sheet of paper. Repeat Steps 3 and 4 for each page to be copied.

5 When you have finished copying, close the rear cover of the machine.



To prevent the possibility of transparencies smudging as they stack in the output bin, remove each transparency after it exits.

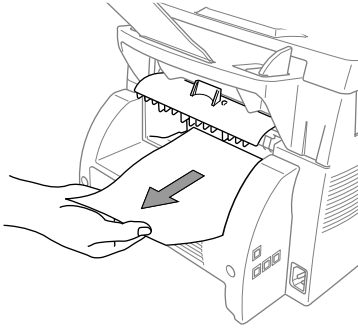

11 Troubleshooting and Maintenance

Error Messages

You may occasionally encounter a difficulty with the machine or telephone line. If this happens, the machine often identifies the problem and displays an error message. The list below explains the most common error messages, in alphabetical order.

ERROR MESSAGE	CAUSE	ACTION
CHANGE DRUM SOON	The drum unit is near the end of its life.	If you have a print quality problem, replace the drum unit with a new one.
	The drum counter was not reset.	1. Open the front cover and press Clear . 2. Press 1 to reset.
CHANGE TONER	If the display shows CHANGE TONER and at the same time the Toner Empty LED on the control panel flashes on and off, you can still print. But the toner is depleted and the machine is telling you that the toner will soon run out.	Order a new toner cartridge now.
CHECK DOCUMENT	Documents were not inserted or fed properly or document was too long.	Do not pull paper out until you see <i>Document Jam</i> , page 63.
CHECK PAPER CHECK PAPER #1* CHECK PAPER #2* *With optional paper tray	The machine is out of paper or paper is not properly loaded in the paper tray.	Refill the paper or remove the paper and load it again.
CHECK PAPER SIZE	Paper Size is improper for fax receiving.	Load A4 paper in tray.
COMM.ERROR	A poor quality phone line caused communications error.	Try the call again.
CONNECTION FAIL	You tried to poll a fax machine that is not in Polled Waiting mode.	Verify the other party's polling setup.
COOLING DOWN	The temperature of the drum unit or toner cartridge is too hot. The machine will pause its current print job and go into cooling down mode. During the cooling down mode, you will hear the cooling fan running while the display on the machine shows COOLING DOWN .	You must wait and allow the machine to resume printing when it is ready.
COVER OPEN	The front cover was not completely closed.	Open, then close the front cover.

ERROR MESSAGE	CAUSE	ACTION
DISCONNECTED	The other party or other party's fax machine terminated the call.	Try to re-transmit or call the other party to see what happened.
MACHINE ERROR XX	Machine has a mechanical problem.	Unplug the machine. Then contact your Brother dealer for service.
NO RESPONSE/BUSY	The number you called does not answer or is busy. Or, you may have reached a number that is not connected to a fax machine.	Check the number and try again.
NOT ASSIGNED	You tried to access a One Touch or Speed Dial number that is not programmed.	Set up the One Touch or Speed Dial number. (See <i>Storing One Touch Dial Numbers</i> , page 19 and <i>Storing Speed Dial Numbers</i> , page 19.)
OUT OF MEMORY	The machine memory capacity has been exceeded.	See <i>Dual Access</i> , page 24 and <i>Out of Memory Message</i> , page 53.
PAPER JAM	The recording paper is jammed in the machine.	See <i>Paper Jam</i> , page 63.
PLS OPEN COVER	A page, piece of paper or paper clip, etc. may be jammed inside the machine.	Open the front cover and remove the drum unit. If you see any jammed paper or other item, gently pull it out, then re-insert the drum unit, close the front cover. If the error message remains, open and close the front cover again. If the machine cannot reset itself and return to the date and time prompt, it will display MACHINE ERROR XX . Please call your Brother dealer for service.
TONER EMPTY	Toner is used up and printing is not possible, or toner cartridge is not installed into the drum unit.	Replace the toner cartridge with a new one, or install the toner cartridge into the drum unit. (See <i>Replacing the Toner Cartridge</i> , page 76.)

Document Jams and Paper jams

Based upon where the original document or printed sheet is jammed, follow the appropriate set of instructions to remove it.

Document Jam

The documents were not inserted or fed properly, or were too long.

- 1 Open the control panel.
- 2 Carefully pull the document toward the front of the machine.
- 3 Close the control panel and press **Stop/Exit**.

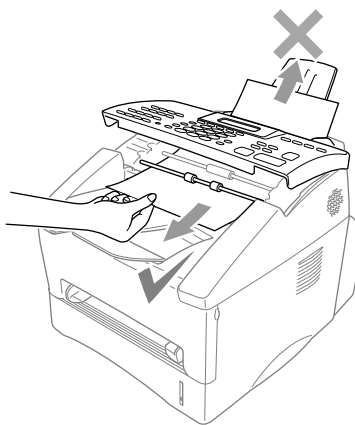

Paper Jam

Before you can clear a paper jam error, you must find out where the paper is stuck. Use the diagram below to help locate the position of the paper.



Do not force the jammed paper from the paper tray because you may damage the machine and cause toner to scatter.

After you have used the machine, some internal parts of the machine are extremely **HOT!** When you open the front or the rear cover of the machine, never touch the shaded parts shown in the following diagram.

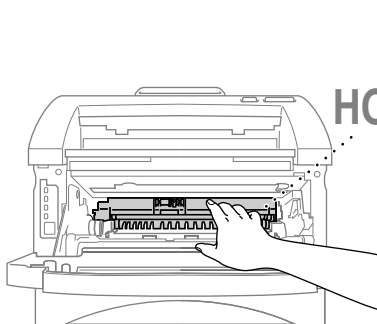

Front view

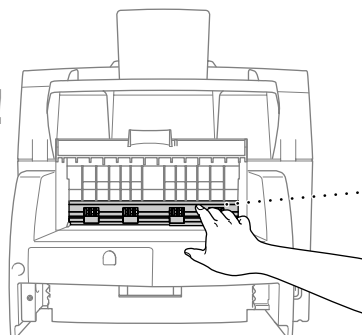

Rear view

Paper is Jammed in the Paper Tray

- 1 Pull the paper tray out of the machine.
- 2 Remove any crinkled sheets.

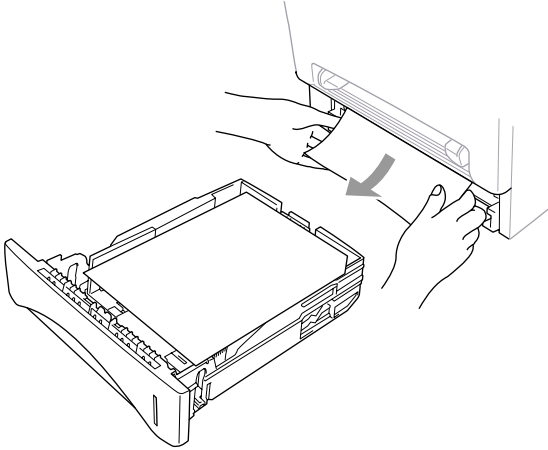

- 3 Adjust the guides at the right and rear of the paper tray to fit.
- 4 Press down the paper to flatten it in the paper tray.
- 5 Reinstall the paper tray.

Paper is Jammed near the Drum Unit

- 1 Open the front cover.
- 2 Remove the drum unit but do not force it if it cannot be removed easily. Instead, pull the edge of the jammed paper from the paper tray.
- 3 Gently pull out the jammed paper.

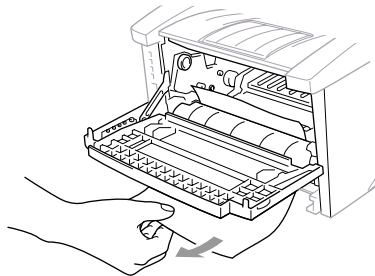
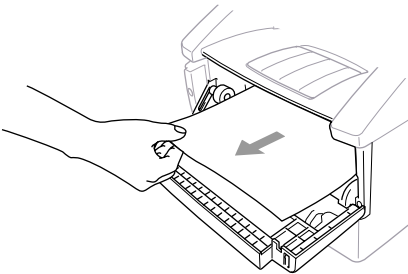

- 4 Reinstall the drum unit.
- 5 Close the front cover.

Paper is Jammed in the Fuser Unit

- 1 Open the rear cover.
- 2 Carefully pull out jammed paper. When you have to pull paper out the back of the machine, the fuser may get dirty with toner powder causing the next few printed page(s) to look messy. Make a few copies until the pages print clearly.

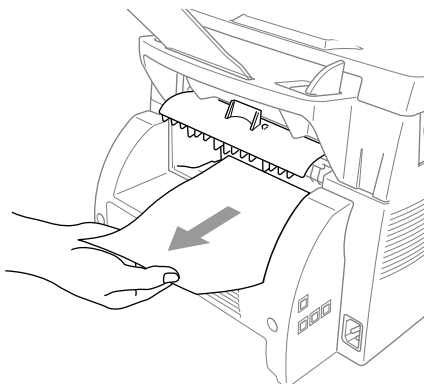







- 3 Close the rear cover.



Difficulty with Operation

If you think there is a problem with the machine, make a copy first. If the copy looks good, the problem is probably not the machine. Check the table below and follow the troubleshooting tips.

DIFFICULTY	SUGGESTIONS
Printing and Receiving Faxes	
Condensed print and horizontal streaks/top and bottom of sentences are cut off.	This can be caused by static or interference on the telephone line. You can make a copy using the Copy function and see if the same problem occurs. If the copy is also bad, call your Brother dealer for service.
Vertical streaks/black lines appear on the fax you receive	Sometimes you may see vertical streaks/black lines on the faxes you receive. Either the machine's primary corona wire for printing may be dirty, or the sending party's fax scanner may be dirty. Clean your primary corona wire, or ask the sender to make a copy to see if the problem is with the sending machine. Try receiving from another fax machine. If the problem continues, call Brother dealer for service.
Machine goes into receive mode when the caller is not a fax	If the machine is set to Fax Detect (with an External Telephone) ON, it is more sensitive to sounds. The machine may mistakenly interpret certain voices or music on the line as a calling fax machine and respond with fax receiving tones. Deactivate the fax by pressing Stop/Exit . Try avoiding this problem by turning Fax Detect (with an External Telephone) to OFF. (See <i>Fax Detect (with an External or Extension Telephone)</i> , page 27.)
Phone Line or Connections	
Dialling does not work	Check for a dial tone. Change TONE/PULSE setting. (See <i>Setting the Dialling Mode (Tone/Pulse)</i> , page 18.) Check all line cord connections. Check power cord connection. Send a manual fax by lifting the external telephone's handset, and dialling the number. Wait to hear fax receiving tones before pressing Fax Start .
The machine does not answer when called	Make sure the machine is in the correct receiving mode for your setup (either Fax, Fax/Tel (F/T) or TAD). Check for dial tone. If possible, call the machine to hear it answer. If there is still no answer, check the telephone line cord connection. If there is no ringing when you call the machine, call your Telephone Company to check the line.
No dial tone on the external telephone's handset	Lifting the external phone's handset. If you hear no dial tone, check telephone line cord connections at the machine and wall socket. Check that the external telephone is connected to the machine correctly. Test the wall socket with another single line telephone. If no dial tone on the wall outlet, call your Telephone Company.

DIFFICULTY	SUGGESTIONS
Sending Faxes	
Poor transmitting quality	Try changing your resolution to FINE or SUPERFINE. (See <i>Fax Resolution</i> , page 21.) Make a copy to verify the machine's scanner operation.
Transmission verification prints "Results:NG"	There is probably temporary noise or static on the phone line. Try sending the fax again. If the problem continues, call the Telephone Company to check your phone line.
When the receiving party says the picture is not clear	Sometime the resolution mode you choose when sending a fax may not be appropriate. Send the fax again, but try using a different resolution mode (FINE or S.FINE). Also, make sure the machines scanner glass is clean and that there are no marks on it. If there is, then clean the glass cover.
When the receiving party says vertical streaks appear on the faxes they receive	The machine's scanner may be dirty or the receiving party's print head may be dirty. Clean your scanner and make a copy to check if the problem was caused by the machine.
Handling Incoming Calls (with external telephone)	
F/T pseudo-ring in Fax/Tel (F/T) Mode.	The machine knows the incoming call is not a fax so it is signalling you to answer the telephone call. Pick up the external telephone's handset and press Tel or answer from an extension phone and press the machine's Deactivation Code (default setting is #51).
Transferring a fax call to the machine.	If you answered at the machine, press Fax Start and hang up immediately. If you answered at an extension phone, press your Remote Activation Code (default setting is *51). When the machine answers, hang up.
Paper Handling Difficulties	
The machine does not load paper. The LCD shows CHECK PAPER or PRINTER JAM	Check to see if the CHECK PAPER or PRINTER JAM message appears on the LCD. If so, the paper tray may be out of paper. If it is empty, load a new stack of paper into the tray. If there is paper in the paper tray, make sure it is straight. If the paper is curled, you should straighten it. Sometimes it is helpful to remove the paper, turn the stack over and put it back into the paper tray. Reduce the amount of paper in the paper tray, then try again.
How can I clear paper jams?	See <i>Paper Jam</i> , page 63.
Copy Quality Difficulties	
Vertical streaks appear in copies	Sometimes you may see vertical streaks on your copies. Either the scanner or the primary corona wire for printing is dirty. Clean them both.

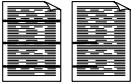
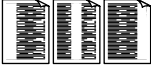
DIFFICULTY	SUGGESTIONS
Print Quality Difficulties	
Printouts are too dark or light	Adjust the print conditions by setting the Print Density function. It has been factory set to the middle position. (See <i>Setting the Print Density</i> , page 28.)
Printed pages contain white stripes.  White Stripes or Faint Images	You may fix this by wiping the laser scanner windows with a clean soft cloth. (See <i>Regular Maintenance</i> , page 73 and <i>Cleaning the Printer</i> , page 74.) If you still see white stripes or faint images and the display shows CHANGE DRUM SOON , replace the drum unit with a new one.
Printed pages are stained with toner or have vertical stripes.  Dark Stripes or Toner Stains	Clean the machine's interior and the primary corona wire of drum unit. (See <i>Regular Maintenance</i> , page 73 and <i>Cleaning the Drum Unit</i> , page 75.) Make sure that the tab of the corona wire is at the home position. If after cleaning, you still see dark stripes or toner stains and the display shows CHANGE DRUM SOON , replace the drum unit with a new one.
Printed pages have white spots in black text and graphic areas.  White Spots	Make sure that you use paper that meets the specifications. (See <i>Acceptable Paper</i> , page 92.) Rough surface or thick media can cause the problem. If you still see white spots and the display shows CHANGE DRUM SOON , replace the drum unit with a new one. This can also cause problems when using copy functions. In this case, check the paper type setting.
Toner scatters and stains the printed page.  Scattering Toner	Adjust the print conditions by setting the Print Density function. (See <i>Setting the Print Density</i> , page 28.) Clean the machine's interior. (See <i>Regular Maintenance</i> , page 73 and <i>Cleaning the Drum Unit</i> , page 75.) Make sure that you use paper that meets specifications. (See <i>Acceptable Paper</i> , page 92.) If you still have scattered toner and the display shows CHANGE DRUM SOON , replace the drum unit with a new one.
The whole page is printed black.  Black Page	Clean the machine's interior and the primary corona wire of the drum unit. (See <i>Regular Maintenance</i> , page 73 and <i>Cleaning the Drum Unit</i> , page 75.) Also, do not use heat-sensitive paper as it will cause this problem. After cleaning, if the printed pages are still black or the display shows CHANGE DRUM SOON , replace the drum unit with a new one. The drum unit may be damaged.
Nothing is printed on the page.  White page	Make sure that the toner cartridge is not empty. If the toner cartridge is empty, replace the toner cartridge. (See <i>Replacing the Toner Cartridge</i> , page 76.)

DIFFICULTY	SUGGESTIONS
<p>Printed pages are marked regular intervals.</p>  <p>Example of Regular Marking</p>	<p>Markings may disappear by themselves. Try copying at multiple pages to clear this problem. Markings may occur if the machine has not been used for a long time. A possible cause is that the surface of the drum is marked or damaged by excessive exposure to light. In this case, replace the drum unit with a new one.</p>
<p>Printed pages are blurred at the centre or at either edge.</p>  <p>Blurred Page</p>	<p>Certain environmental conditions such as humidity, high temperatures, etc. may cause this condition to occur. Make sure the machine is placed on a flat, horizontal surface. Remove the drum unit with the toner cartridge installed. Try rocking them from side to side. You may clear a blurred page by wiping the scanner window with a clean soft cloth. (See <i>Regular Maintenance</i>, page 73.) If a blurred page occurs after cleaning and the display shows CHANGE DRUM SOON, replace the drum unit with a new one.</p>
<p>Ghost images appear on printed page.</p>  <p>Ghost Images</p>	<p>Adjust the print conditions by setting the Print Density function. (See <i>Setting the Print Density</i>, page 28.) Make sure that you use paper that meets the specifications. (See <i>Acceptable Paper</i>, page 92.) Rough surfaces or thick media can cause a ghost image.</p>



The drum unit is a consumable and it is necessary to replace it periodically.

Packing and Shipping the Machine

Whenever you transport the machine, use the packing materials that came with the machine. If you do not pack the machine correctly, you could void your warranty.

- 1 Remove the telephone line cord and the power cord and pack them.
- 2 Open the front cover.
- 3 Remove the drum unit assembly.



Remove the drum unit and toner cartridge assembly. Leave the toner cartridge installed in the drum unit.

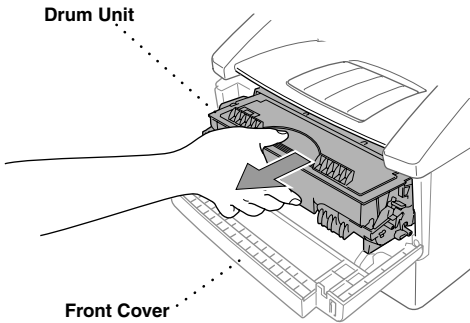

- 4 Place the drum unit and toner cartridge assembly into the plastic bag and seal the bag completely.

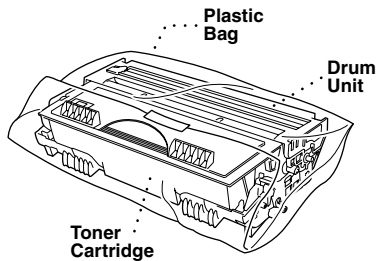

- 5 Close the front cover. Fold down the front output bin extension. Remove the document tray and document support, and pack them.

- 6 If optional Lower Tray is connected, unplug the modular cable from the modular jack of the Brother machine.

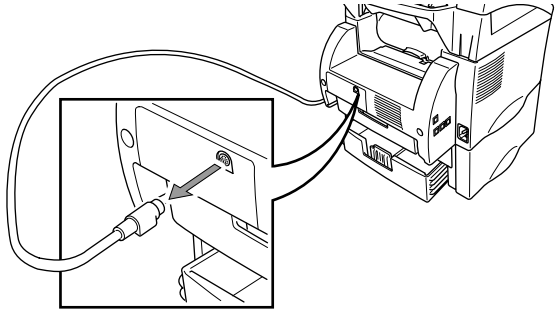

- 7 Carefully pick up the machine and remove Lower Tray to pack it *separately* in the original carton with the original packing material.

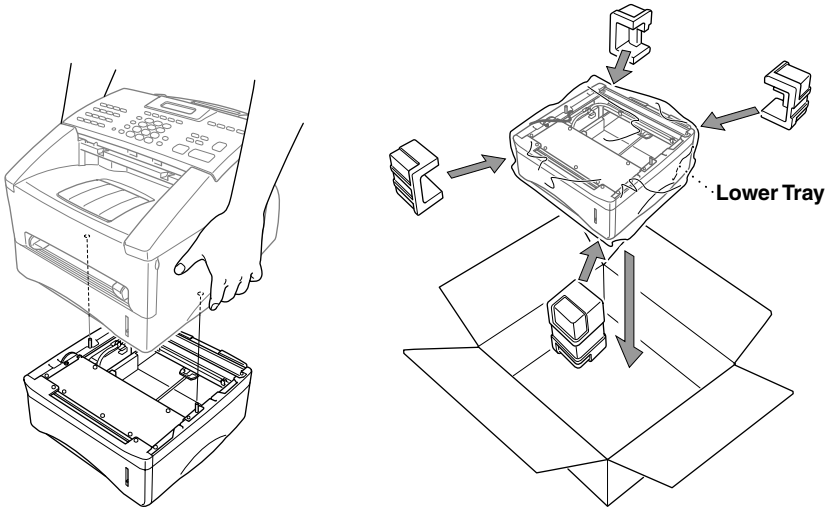

- 8** Wrap the machine in the plastic bag and place it in the original carton with the original packing material.

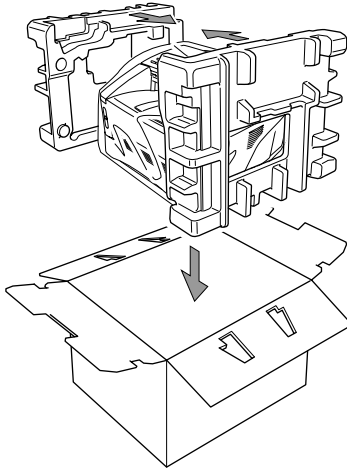

- 9** Place documents (manual and printed material), document tray, and document support, drum unit and toner cartridge assembly, the telephone line cord and power cord into the carton as shown below.

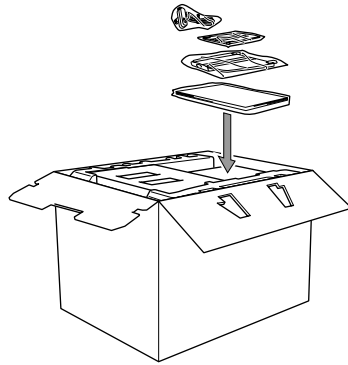
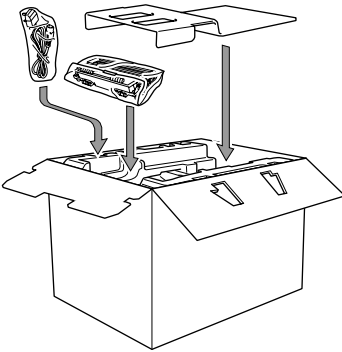

- 10** Close the carton and tape it shut.

Regular Maintenance

You can keep the machine in optimum condition by cleaning it on a regular basis. It is a good idea to clean the drum unit during this routine. Avoid using thinners or other organic solvents to clean the machine and do not use water.

Cleaning the Scanner

- 1 Unplug the telephone line and then the power cord.
When you reconnect these lines later, make sure to connect the power cord first, then the telephone line.
- 2 Lift the control panel cover.
- 3 Clean the white bar and the glass cover.
Moisten a small piece of clean soft, lint-free cloth with isopropyl alcohol and carefully remove dirt from the glass cover and the white bar of the scanner.

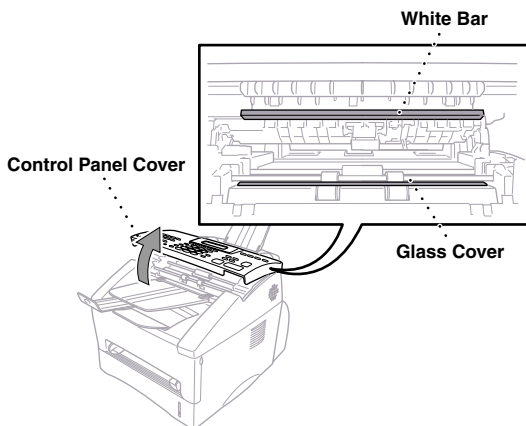

- 4 Close the control panel cover.

Cleaning the Printer



- Do not use isopropyl alcohol to remove dirt from the control panel. It may cause a crack on the panel.
- Do not use isopropyl alcohol to clean the scanner window or the toner sensor.
- Do not touch the scanner window with your finger.
- Handle the drum unit carefully as it contains toner. If toner scatters and your hands or clothes get dirty, immediately wipe or wash it off with cold water.

1 Open the front cover.

2 Remove the drum unit assembly.



After you have used the machine, some internal parts of the machine are extremely **HOT!** When you open the front cover of the machine, never touch the shaded parts shown in the diagram below.

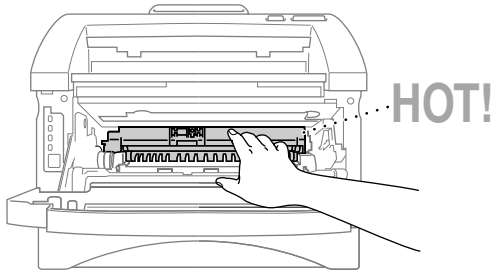

3 Gently clean the scanner window with a clean soft dry cloth. Do not use isopropyl alcohol.

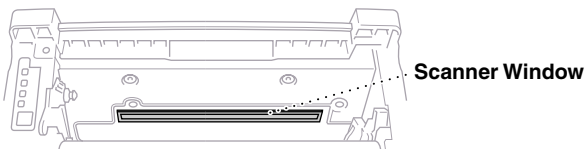

Cleaning the Drum Unit

We recommend you place the drum unit on a drop cloth or large piece of disposable paper to avoid spilling and scattering toner.

- 1 Clean the primary corona wire inside the drum unit by gently sliding the tab from right to left several times.
- 2 Return the tab to the home position (▼ mark position) before reinstalling the drum unit.

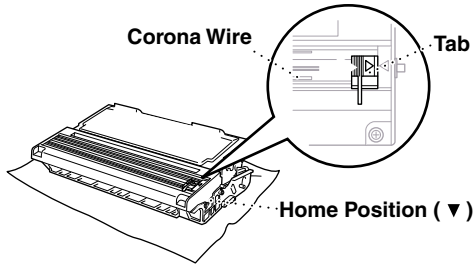

If you do not position the tab at the home position, printed pages may have vertical stripes.

- 3 Install the drum unit into the machine. (See *Replacing the Drum Unit*, page 80.)
- 4 Close the front cover.

Replacing the Toner Cartridge

The machine can print up to 6,000 pages using a *high yield* toner cartridge (TN-6600). When the toner cartridge is running low, the display shows **CHANGE TONER**. The machine is supplied with a *standard* toner cartridge (TN-6300) that must be replaced after approximately 3,000 pages. Actual page count will vary depending on your average document type.

It is a good idea to keep a new toner cartridge ready for use when you see the toner low warning.

Discard the used toner cartridge according to local regulations. If you are not sure of them, consult with Brother dealer for service. Be sure to seal the toner cartridge tightly so toner powder does not spill out of the cartridge. When discarding used toner cartridges, keep them separate from domestic garbage.

It is recommended that you clean the machine when you replace the toner.

Toner Empty Indicator

When the toner cartridge is running low, the display shows **CHANGE TONER** and the Toner Empty LED on the control panel flashes on and off to indicate the toner is low.

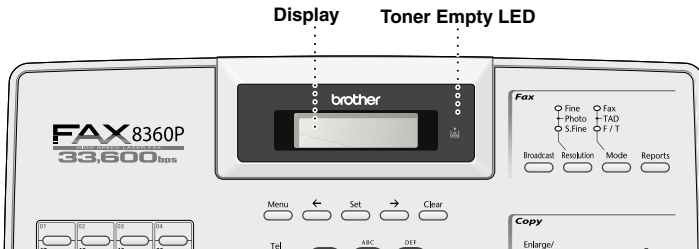

The Toner Empty LED light stays on and the display shows **TONER EMPTY** to indicate that the toner is empty. Once this indication appears, the machine will not resume printing until you have installed a new toner cartridge.

Steps for Replacing Toner Cartridge



After you have just used the machine, some internal parts of the machine will be extremely **HOT!** So, never touch the shaded parts shown in the illustration below.

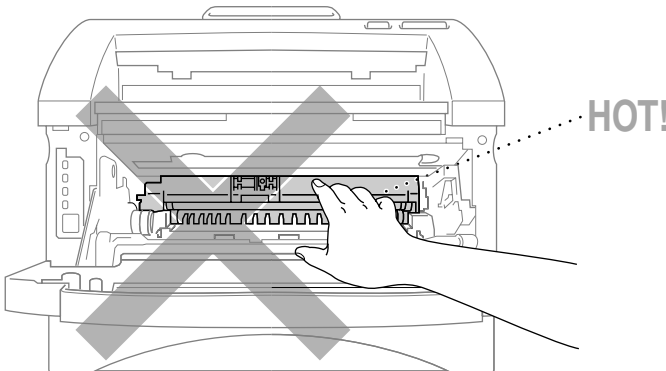

- 1 Open the front cover and pull out the drum unit.

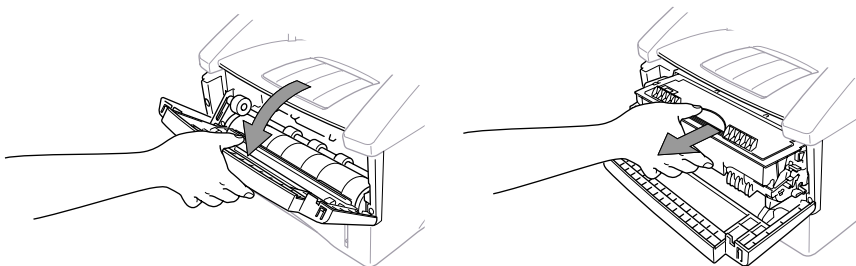

Place the drum unit on a drop cloth or large piece of disposable paper to avoid spilling and scattering the toner.

- 2 Hold down the lock lever on the right and pull the toner cartridge out of the drum unit assembly.

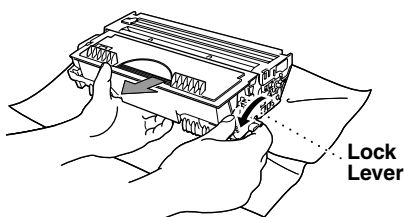

Handle the toner cartridge carefully. If toner scatters on your hands or clothes, immediately wipe it off or wash them with cold water.

- 3 Unpack the new toner cartridge. Place the used toner cartridge into the aluminium bag and discard it according to local regulations.



- Wait to unpack the toner cartridge until immediately before you install it into the machine. If a toner cartridge is left unpacked for a long period of time, the toner life is shortened.
- You can use only a genuine Brother toner cartridge (TN-6300 or TN-6600), which is specially formulated to ensure top print quality. Using another brand of toner cartridge may void your machine's warranty.

4 Gently rock the toner cartridge from side to side five or six times.

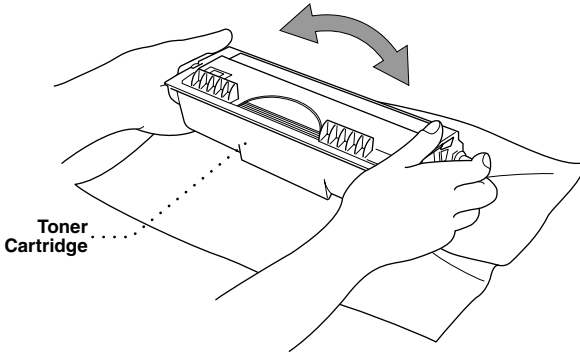

5 Remove the protective cover.

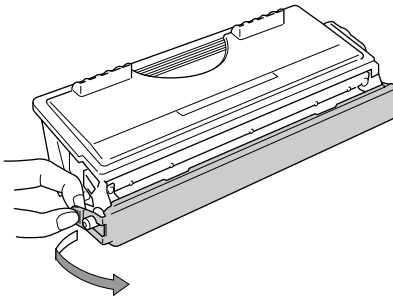

6 Install the new toner cartridge into the drum unit until it clicks into place.

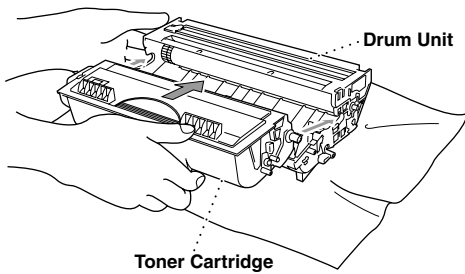

- 7** Clean the primary corona wire inside the drum unit by gently sliding the blue tab from right to left several times. Return the blue tab to the home position before reinstalling the drum unit assembly.

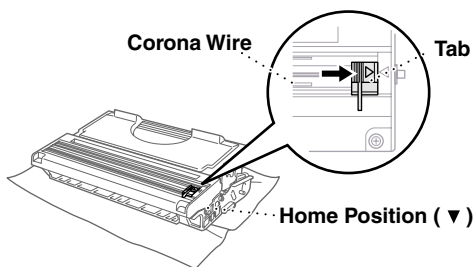

- 8** Reinstall the drum unit into the machine and close the front cover.

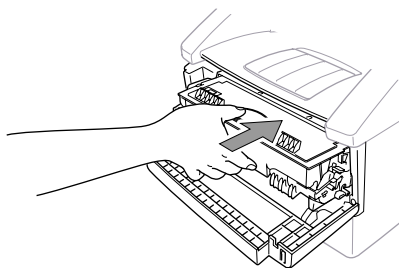

Drum Life Considerations for Your Brother Fax Machine

Your Brother fax machine uses a drum and toner assembly for document printing. The toner life is directly dependent upon the amount of black printing on the printed pages. The estimated drum life is up to 20,000 A4 sized pages. Maintaining quality print during this period will depend on factors such as the number of pages printed per day, time between printouts, the paper quality and the environment in which the machine is used.

The drum unit (DR-6000) is a consumable and to maintain an acceptable printing quality it should be replaced at the end of its 20,000 A4 page life. Printing quality is a subjective issue and the drum should be replaced at a time when the printing quality becomes unacceptable to the user in relation to the documents being printed. The print quality will deteriorate over time and replacing the drum will return the printing quality to its optimum level. In order to maintain optimum print quality, we also recommend that the drum is replaced after 18 months service.

To assist you, the machine will advise when approximately 5-15% of the drum life remains by showing the message **CHANGE DRUM SOON** on the display.

This indication takes the number of pages printed and the total printing time into consideration. When the message appears we advise that a new drum be obtained for replacement at a convenient future time.

1 Press **Menu, 2, 0, 3**.

2 The following indication appears on the LCD for 5 sec, and the display returns automatically to **MISCELLANEOUS** menu.

DRUM LIFE
REMAINING : ###%

3 Press **Stop/Exit** to exit.



We emphasise that even if the drum life remaining indicates 0%, you only need to replace the drum if the print quality is unacceptable. By using a drum past the 0% indication no damage will be caused to the machine and whilst the print quality remains acceptable then the drum may be used beyond its designed life.

Replacing the Drum Unit

The machine uses a drum unit to create the print images on paper. If the screen displays **CHANGE DRUM SOON**, the drum unit is nearly at the end of its life. Prepare a new drum unit to replace the current one. You may need to order one from your Brother dealer.

Even if the display shows **CHANGE DRUM SOON**, you may be able to continue to print without replacing the drum unit for a while. However, if there is a noticeable deterioration in the output print quality even before **CHANGE DRUM SOON** is shown, then the drum unit should be replaced. You should clean the machine when you replace the drum unit.



When removing the drum unit, handle carefully because it contains toner. When you replace the drum unit, you should clean the machine.



The actual number of pages your drum will print may be significantly less than these estimates. Because we have no control over the many factors that determine the actual drum life, we cannot guarantee a minimum number of pages that will be printed by your drum.

For best performance, use only genuine Brother toner, and the product should be used only in a clean, dust-free environment with adequate ventilation.



After you have just used the machine, some internal parts of the machine will be extremely HOT! So please be careful.

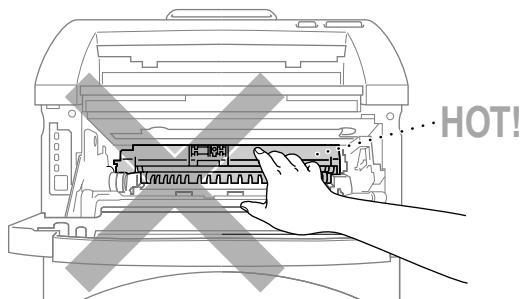

Follow these steps to replace the drum unit:

- 1** Open the front cover.
- 2** Remove the old drum unit. Place the drum unit on an old cloth or large piece of disposable paper to avoid spilling and scattering the toner.

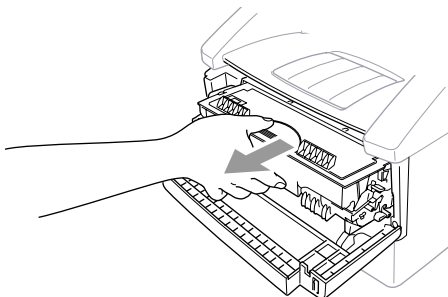

- 3** Pull the toner cartridge out of the drum unit assembly while holding down the lock lever with your right hand. (See *Replacing the Toner Cartridge*, page 76.)

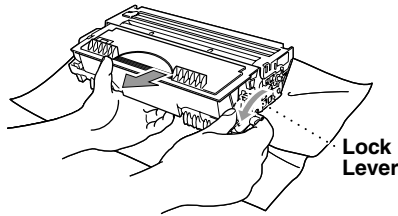

Discard the used drum unit according to local regulations. Be sure to seal the drum unit tightly so toner powder does not spill out of the unit. When discarding used drum units, keep them separate from domestic rubbish.

- 4** Wait to unpack the new drum unit until immediately before installing it. Place the old drum unit into the aluminium bag and discard it according to local regulations.



- **If an unpacked drum unit is subjected to excessive direct sunlight or room light, the unit may be damaged.**
- **Handle the toner cartridge and the drum unit carefully because they contain toner. If toner scatters and your hands or clothes get dirty, immediately wipe or wash with cold water.**
- **Do not touch the scanner window with your finger.**

- 5** Reinstall the toner cartridge into the new drum unit. (See *Replacing the Toner Cartridge*, page 76.)

- 6** Reinstall the new drum unit, keeping the front cover open.

- 7** Press **Clear** to reset the drum life counter.

- 8** Press **1**, and when the display shows **ACCEPTED** close the front cover.

REPLACE DRUM?
1 . YES 2 . NO

Important Safety Instructions

- 1** Read all of these instructions.
- 2** Save them for later reference.
- 3** Follow all warnings and instructions marked on the product.
- 4** Unplug this product from the telephone and AC sockets (in this order) before cleaning. Do not use liquid or aerosol cleaners. Use a damp cloth for cleaning.
- 5** Do not place this product on an unstable surface.
- 6** Slots and openings in the case and the back or bottom are provided for ventilation; to ensure reliable operation of the product and to protect it from overheating, these openings must not be blocked or covered. The openings should never be blocked by placing the product on a bed, sofa, rug, or other similar soft surface. This product should never be placed near or over a radiator or heater. This product should not be placed in a built-in installation unless proper ventilation is provided.
- 7** This product should be operated from the type of power source indicated on the label. If you are not sure of the type of power available, consult with your dealer or local power company.
- 8** This product is equipped with a 3-wire earthed plug. This plug will fit into only an earthed socket. This is a safety feature. If you are unable to insert the plug into the outlet, contact your electrician to replace your obsolete socket. Do not defeat the purpose of an earthed plug.
- 9** Do not allow anything to rest on the power cord. Do not locate this product where people can walk on the cord.
- 10** Do not place anything in front of the machine that will block received faxes. Do not place anything in the path of received faxes.
- 11** Do not touch a document during printing.
- 12** Never push objects of any kind into this product through cabinet slots, since they may touch dangerous voltage points or short out parts resulting in a risk of fire or electric shock. Never spill liquid of any kind on the product.
- 13** Do not attempt to service this product yourself, because opening or removing covers may expose you to dangerous voltage points and/or other risks. Refer all servicing to service personnel.
- 14** This product has no mains ON/OFF switch. It is therefore highly important that access to the mains plug and the mains socket to which the plug is connected, is never obstructed, in case for some reason the mains power to the machine must be quickly disconnected.

- 15** Unplug this product from the mains power and telephone line sockets, and refer servicing to qualified service personnel under the following conditions:
- ◆ When the power cord is damaged or frayed.
 - ◆ If liquid has been spilled into the product.
 - ◆ If the product has been exposed to rain or water.
 - ◆ If the product does not operate normally when the operating instructions are followed. Adjust only those controls that are covered by the operating instructions. Improper adjustment of other controls may result in damage and will often require extensive work by a qualified technician to restore the product to normal operation.
 - ◆ If the product has been dropped or the cabinet has been damaged.
 - ◆ If the product exhibits a distinct change in performance, indicating a need for service.

16 We do not advise the use of an extension lead.

IEC 60825 Specification

This machine is a Class 1 laser product as defined in IEC 60825 specifications. The label shown below is attached in countries where required.

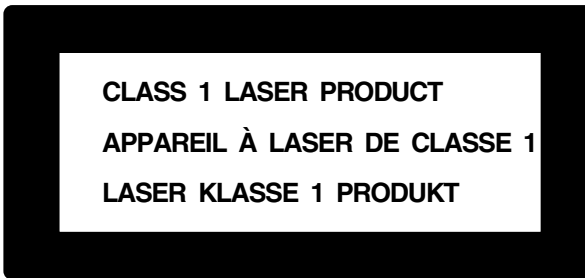

This machine has a Class 3B Laser Diode which emits invisible laser radiation in the Scanner Unit. The Scanner Unit should not be opened under any circumstances.

Laser Diode

Wave length: 760 - 810 nm
Output: 5 mW max.
Laser Class: Class 3B

Caution

Use of controls, adjustments or performance of procedures other than those specified in this manual may result in hazardous radiation exposure.

The following caution label is attached near the scanner unit.

CAUTION	INVISIBLE LASER RADIATION WHEN OPEN AND INTERLOCK DEFEATED. AVOID DIRECT EXPOSURE TO BEAM. CLASS 3B LASER PRODUCT.
ADVARSEL	USYNLIG LASER STRÅLING NÅR KABINETLÅGET STÅR ÅBENT. UNGDÅ DIREKTE UDSÆTTELSE FOR STRÅLING. KLASSE 3B LASER.
VARNING	OSYNLIG LASERSTRÅLNING NÅR DEN HÅR DELEN ÄR ÖPPNAD OCH SPÄRRAR ÄR URKOPPLADE. STRÅLEN ÄR FARLIG. KLASS 3B LASER APPARAT.
VARO!	AVATTAESSA JA SUOJALUKITUS OHITETTAESSA OLET ALTTIINA NÄKYMÄTTÖMÄLLE LASERSÄTEILYLLE. ÄLÄ KATSO SÄTEESEEN. LUOKAN 3B LASERLAITE.
ADVARSEL	USYNLIG LASERSTRÅLING, UNNGÅ DIREKTE KONTAKT MED LASERENHETEN NÅR TOPPDEKSELET ER ÅPENT. KLASSE 3B LASERPRODUKT.
ATTENTION	RADIATIONS LASER INVISIBLES OUAND OUVERT ET VERROUILLAGE ENLEVE. EVITER EXPOSITIONS DIRECTES AU FAISCEAU. PRODUIT LASER CLASSE 3B.
VORSICHT	UNSICHTBARE LASERSTRAHLUNG WENN ABDECKUNG GEÖFFNET UND SICHERHEITSVERRIEGELUNG ÜBERBRÜCKT. NICHT DEM STRAHL AUSSETZEN. SICHERHEITSKLASSE 3B.
ATENCIÓN	RADIACIÓN LASER INVISIBLE CUANDO SE ABRE LA TAPA Y EL INTERRUPTOR INTERNO ESTÁ ATASCADO. EVITE LA EXPOSICIÓN DIRECTA DE LOS OJOS. PRODUCTO LASER CLASE 3B.



For Your Safety

To ensure safe operation the three-pin plug supplied must be inserted only into a standard three-pin power point which is effectively grounded through the normal household wiring.

The fact that the equipment operates satisfactorily does not imply that the power is grounded and that the installation is completely safe. For your safety, if in any doubt about the effective grounding of the power, consult a qualified electrician.

Disconnect device

This product must be installed near a socket outlet that is easily accessible. In case of emergencies, you must disconnect the power cord from the socket outlet in order to shut off power completely.

13 Optional Accessories

Memory Board

When you add the optional memory board, it increases the performance for both fax and copy operations. The optional memory board allows you to store more fax pages or to copy more pages with the sort function etc.

Model Name	Optional Memory (recommended)
FAX-8360P with Standard Memory: 8MB	16 MB BUFFALO TECHNOLOGY 12323-0001
	32 MB BUFFALO TECHNOLOGY 12324-0001

In general, the DIMM must have the following specifications:

Type:	100 pin and 32 bit output
CAS Latency:	2 or 3
Clock Frequency:	66 MHz or more
Capacity:	16 or 32 MB
Height:	46 mm (1.8 inches) or less
Parity:	NONE
DRAM Type:	SDRAM 4 Bank

Some DIMMs may not work with the machine. For more information, consult the dealer where you purchased the machine. For the latest information from Brother visit: <http://solutions.brother.com>

Installing the Optional Memory Board

- 1 Remove the sub cover.

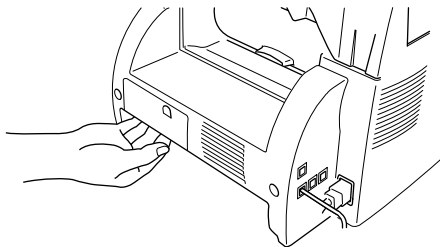

- 2 Disconnect the telephone line cord and unplug the machine power cord from the AC mains outlet.



- Unplug the power cord before installing (or removing) the memory board.
- Do NOT touch the surface of the main board within 15 minutes after unplugging the power cord.
- Installing or removing the optional memory board wipes out all the received fax messages, the ones that will be sent and the data of Journal Report stored in the machine's memory (because the connector of the backup battery is removed).

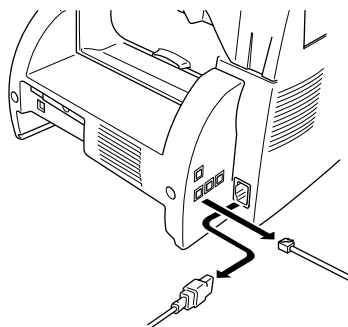

- 3 Remove the screws securing the rear cover and remove the cover.

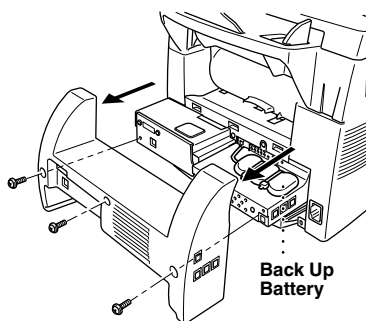

- 4** Remove the screws securing the access plate and remove the plate.

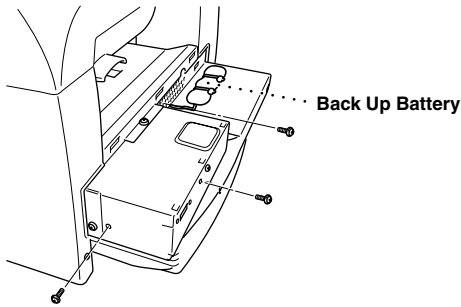

- 5** Disconnect the connector of the back up battery.

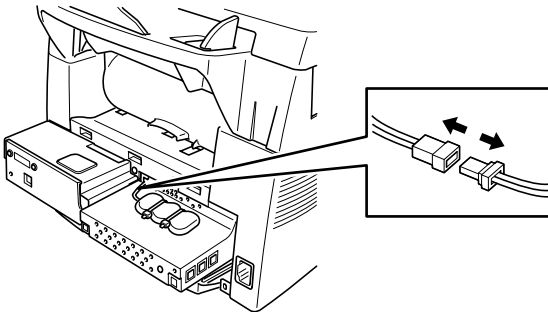

- 6** To install the memory board, align it with the memory socket on the main controller board and push firmly into place, as shown below.

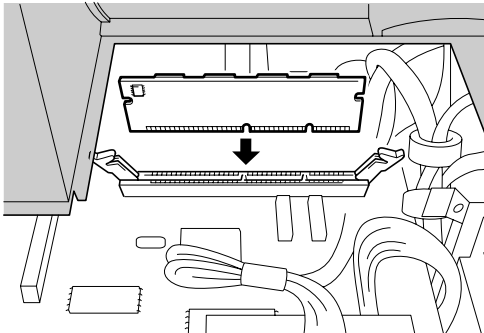



- Hold the memory board by its edges. Do not touch the surface of the board.

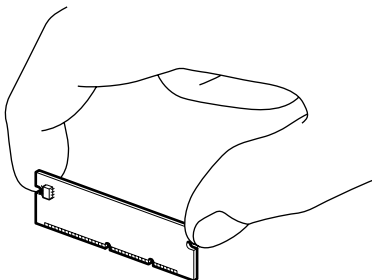

- Make sure the memory board is securely seated in the main controller board.

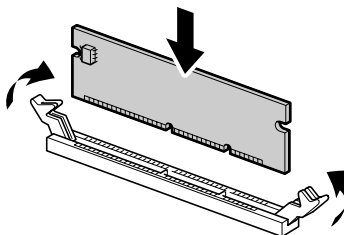

- 7 Reconnect the connector of the back up battery.
- 8 Reinstall the access plate and the rear cover, using the removed screws.
- 9 Plug the power cord into the AC mains outlet and connect the telephone line cord.

Optional Paper Tray

You can purchase the Paper Tray accessory (LT400) to use as an additional paper source. The paper tray holds up to 250 sheets of 20 lb (75 m/g²) paper.

14 Specifications

Compatibility	ITU-T Group 3
Coding system	MH/MR/MMR/JBIG
Modem speed	33600 - 2400 bps; Automatic Fallback
Document input width	148 mm to 216 mm
Document input length	100 mm to 360 mm
Scanning width	207 mm
Printing width	208 mm
Automatic Document Feeder (ADF)	Up to 30 sheets (75 g/m ²)
Paper tray	250 sheets (75 g/m ²)
Output tray	150 sheets (75 g/m ²)
Printer type	Laser Printer
Grey scale	64 levels (Error Diffusion)
Display	LCD, 16 characters x2
Polling types	Standard, Secure, Delayed, Sequential
Contrast control	Automatic/Light/Dark (manual setting)
Resolution	<ul style="list-style-type: none">• Horizontal 8 dots/mm• Vertical Standard—3.85 lines/mm Fine, Photo—7.7 lines/mm Superfine, Photo (copy)—15.4 lines/mm
Out of paper Reception	Up to 500 pages* in memory
One Touch Dial	32 stations
Speed Dial	200 stations
Automatic redial	3 times at 5 minute intervals
Speaker type	Monitor
Auto answer	1, 2, 3 or 4 rings
Communication source	Public switched telephone network (PSTN)
Printer Method	Electrophotography by semiconductor laser beam scanning
Resolution	600 dots/inch
Print Quality	Normal printing mode Economy printing mode

*“Pages” refers to the “ITU-T Chart #1” with JBIG coding and standard resolution.

Consumable Items

Toner cartridge:

Life Expectancy:

Up to 6,000 pages/high yield toner cartridges (TN-6600)

Up to 3,000 pages/standard toner cartridges (TN-6300)
(when printing A4 paper at 5% print coverage)

Toner life expectancy will vary depending on the type of average print job.

Drum Unit:

Life Expectancy: Up to 20,000 pages

There are many factors that determine the actual drum life, such as temperature, humidity, type of paper and toner that you use, the number of pages per print job, etc.

Electrical and Environment

Temperature

(Allowable) 10 - 32.5°C

(Storage) 0 - 40°C

Warm-up

Approx. 25 seconds at 23° C

Power source

220 ~ 240V AC 50/60Hz

Power consumption

Operating (Copying): 350 W or less (25°C)

Peak: 940 W

Sleep Mode: 10 W or less

Stand by: 70 W or less (25°C)

Noise

Operating: 53 dB A or less

Stand by: 30 dB A or less

Humidity

Operating: 20 to 80% (without condensation)

Storage: 20 to 80% (without condensation)

Dimensions (W x D x H)

377 x 442 x 323 mm

Weight

12 kg

Memory

8 MB

Acceptable Paper

	Paper Type	Paper Size
Paper Tray #1 & #2:	Cut sheet and Transparencies	For fax receive - A4 (Cut sheet only) ; for copying - A4, Executive, B5 (ISO), B6 (ISO), A5, A6 (for tray #1 Only)
Manual Feed Slot:	Cut sheet	A4, Letter, Legal, Executive, B5 (ISO), A5, B6 (ISO), A6, Custom size 70-216 x 116-356 mm (2.75-8.5 x 4.57-14 inches)
	Envelopes	DL, C5, COM-10, Monarch
	Post Card	70-216 x 116-356 mm (2.75-8.5 x 4.57-14 inches)
	Labels and Transparencies	70-216 x 127-356 mm (2.75-8.5 x 5-14 inches)

Paper Specification for the Tray

	Cut Sheet
Basis Weight	16 to 28 lb (60 to 105 g/m ²)
Caliper	0.08 to 0.13 mm (0.003 to 0.005 inches)
Moisture Content	4% to 6% by weight
Smoothness	100 to 250 (Sheffield)

Manual Feed Slot:

	Cut Sheet	Envelope
Basis Weight	16 to 43 lb (60 to 161 g/m ²)	20 to 24 lb (75 to 90 g/m ²)
Caliper	0.08 to 0.2 mm (0.003 to 0.008 inches)	0.084 to 0.14 mm 0.003 to 0.005 inches)
Moisture Content	4% to 6% by weight	4% to 6% by weight
Smoothness	100 to 250 (Sheffield)	100 to 250 (Sheffield)

Recommended paper types:

Plain Paper:	Xerox Premire 80
Transparency:	3M CG3300 for laser printers or equivalent
Label:	Avery laser label L7163

Specifications are subject to change for improvement without prior notice.

Compilation and Publication Notice

Under the supervision of Brother Industries Ltd., this manual has been compiled and published, covering the latest product's descriptions and specifications.

The contents of this manual and the specifications of this product are subject to change without notice.

Brother reserves the right to make changes without notice in the specifications and materials contained herein and shall not be responsible for any damages (including consequential) caused by reliance on the materials presented, including but not limited to typographical and other errors relating to the publication.

Trademarks

Brother is a registered trademark of Brother Industries, Ltd.

The brother logo is a registered trademark of Brother Industries, Ltd.

NT is a trademark of Northern Telecom Limited.

All other brand and product names mentioned in this User's Guide are registered trademarks of their respective companies.

Ordering Accessories and Supplies

For the best quality results use only genuine Brother accessories. These are available from most Brother dealers or alternatively you can contact our mail order department on telephone number 0870 830 4037. (For UK only)

Model Name	Description
Laser Fax Toner	TN-6300 (Able to print up to 3,000 pages) TN-6600 (Able to print up to 6,000 pages)
Laser Fax Drum	DR-6000

Entering Text

When you are setting certain functions, such as the Station ID, you may need to enter text into the machine. Most keys on the dial pad have three or four letters printed above them. The keys for **0**, **#**, and ***** don't have printed letters because they are used for special characters.

By pressing the appropriate number on the dial pad the correct number of times, you can access the character you want.

Press Key	one time	two times	three times	four times	five times
2	A	B	C	2	A
3	D	E	F	3	D
4	G	H	I	4	G
5	J	K	L	5	J
6	M	N	O	6	M
7	P	Q	R	S	7
8	T	U	V	8	T
9	W	X	Y	Z	9

Inserting spaces

If you want to enter a blank space, press  twice.

Making corrections

If you entered a letter incorrectly and want to change it, press  to move the cursor after the last correct letter. Then press **Clear**; all letters above and to the right of the cursor are deleted. Re-enter the correct text and/or digits. You can also back up and type over incorrect letters.

Repeating letters

If you need to enter a character assigned to the same key as the previous character, press  to move the cursor to the right.

Special characters and symbols

Press the *****, **#**, or **0** key repeatedly to move the cursor under the special character or symbol you want. Then press  to add the character to your text.

0 key Ä Æ Ö Ü À Ç È É 0

***** key (space) ! " # \$ % & ' () * + , - . / €

key ; : < = > ? @ [] ^ _

About Fax Machines

If you are a first-time fax machine user, fax operation might seem a little mysterious. You will soon get used to the unusual fax tones on your phone line, and be able to send and receive faxes easily.

Fax Tones and Handshake

When someone is sending a fax, the fax machine sends fax calling tones, (CNG tones)—soft, intermittent beeps at 4-second intervals. You will hear them when you dial and press **Fax Start**, and they continue for about 60 seconds after dialling. During that time, the sending machine must begin the “handshake” with the receiving machine. Each time you use automatic procedures to send a fax, you are sending CNG tones over the phone line. You will soon learn to listen for these soft beeps each time you answer a phone on your fax line, so you can know if you are receiving a fax message.

The receiving fax responds with fax receiving tones—loud, chirping sounds. A receiving fax chirps for about 60 seconds over the phone line, and the screen displays **RECEIVING**. If the machine is set to the Fax Only Mode, it will answer every call automatically with fax receiving tones. Even if the other party hangs up, the machine continues to send the “chirps” for about 60 seconds, and the screen continues to display **RECEIVING**. To cancel the receiving mode, press **Stop/Exit**.

When the machine is in Fax/Tel (F/T) Mode, it answers with a short beep. After this beep, the fax machine listens for CNG tones, and then responds with receiving tones.

The fax “handshake” is the time in which the sending machine’s CNG tones and the receiving machines “chirps” overlap. This must be for at least 2 to 4 seconds, so the fax machines can understand how each is sending and receiving the fax. The handshake cannot begin until the call is answered, and the CNG tones only last for about 60 seconds after the number is dialled. Therefore, it’s important for the receiving machine to answer the call in as few rings as possible.



When you have an external telephone answering device (TAD) on your fax line, your TAD will determine the number of rings before the call is answered. Pay special attention to the directions in the Preparation and Simple use chapter for connecting a TAD (or answering machine) to the machine.

ECM (Error Correction Mode)

The Error Correction Mode (ECM) is a way for the fax machine to check the integrity of a fax transmission while it is in progress. ECM transmissions are possible only between machines that both have the ECM feature. If they do, you may send and receive fax messages that are continuously checked for their integrity.

Sufficient memory must be available in the machine for this feature to work.

Glossary

ADF (Automatic Document Feeder Capacity) Refers to the number of pages that can be placed in the document feeder and fed one at a time automatically.

Auto reduction Reduces the size of incoming faxes.

Automatic Fax Transmission Sending a fax without picking up the handset of an external telephone.

Automatic Redial A feature that enables the machine to redial the last fax number if the original fax did not go through because the line was busy or there was no answer.

Backup Print Sets the machine to print a copy of faxes that are received and stored in memory.

Beeper The sound the keys make when they are pressed, an error occurs or a document has been received or transmitted.

Beeper Volume Volume setting for the beep when you press a key or make an error and at the end of sending or receiving a fax.

Broadcasting The ability to send the same fax message to more than one location.

CNG tones The special tones (beeps) sent by fax machines during automatic transmission to tell the receiving machine that they are from a fax machine.

COMM. ERROR (Communication error) An error during fax sending or receiving, usually caused by line noise or static.

Coding Method Method of coding the information contained in a document. All fax machines must use a minimum standard of Modified Huffman (MH). The machine is capable of greater compression method, Modified Read (MR) and Modified Modified Read (MMR), JBIG if the receiving machine has the same capability.

Compatibility Group The ability of one fax unit to communicate with another. Compatibility is assured between ITU-T Group.

Contrast Setting to compensate for dark or light documents, by lightening dark documents or darkening light documents.

Cover Page Prints a page at the other party's machine, that contains the sender and recipient's name and fax number, number of pages and comment. You can generate an electronic cover page at the other end with pre-programmed information from memory or you can print a sample cover page to fax with your document.

Cover Page Message The comment that is on the Cover Page. This is a programmable feature.

Delayed Transmission Sends your fax at a later time that day.

Drum unit A printing device for the machine.

Dual Access The machine can scan outgoing faxes or scheduled jobs into memory at the same time it is sending a fax or receiving or printing an incoming fax.

ECM (Error Correction Mode) Detects errors during fax transmission and resends the parts of the document that had errors.

Electronic Cover Page A preprogrammed cover page that is transmitted from the fax machine's memory, eliminating the need for making up cover pages manually.

Extension Phone A telephone on the fax number that is plugged into a separate wall jack.

- External Phone** A TAD (telephone answering device) or telephone that is plugged into the Ext. socket of the machine.
- F/T Ring Time** The length of time the machine rings (when the receive mode setting is Fax/Tel) to notify you to pick up a voice call that has been automatically answered.
- Fax/Tel mode** You can receive faxes and telephone calls. Do not use Fax/Tel if you are using an external answering machine. (With external telephone only)
- Fax Forwarding** Sends a fax received in memory to another preprogrammed fax number.
- Fax Storage** You can store faxes in memory for remote retrieval.
- Fax tones** The signals sent by sending and receiving fax machines while communicating information.
- Fine Mode** Resolution is 203 x 196 dpi. It is used for small print and graphs.
- Grey scale** The shades of grey available for copying and faxing photographs.
- Group number** A combination of One Touch and/or Speed Dial numbers that are stored on a One Touch Dial key or Speed Dial # for Broadcasting.
- Journal** Lists information about the last 200 incoming and outgoing faxes. TX means Transmit. RX means Receive.
- Journal Period** The preprogrammed time period between automatically printed Journal Reports. You can print Journal on demand without interrupting this cycle.
- LCD (Liquid crystal display)** The display screen on the machine that shows interactive messages during On-Screen Programming and defaults to the date and time when the machine is idle.
- Manual fax** When you lift the external telephone's handset so you can hear the receiving fax machine answer before you press **Fax Start** to begin transmission.
- Menu Mode** The programming mode for changing the setting of the machine.
- One Touch Dial** Keys on the machine control panel where you can store numbers for easy dialling. You must use a separate key for each number.
- Out of Paper Reception** Receives faxes into the machine's memory when the machine is out of paper.
- Overseas Mode** Makes temporary changes to the fax tones to accommodate noise and static on overseas phone lines.
- Pause** Allows you to place a 3.5 second delay in the dialling sequence stored.
- Photo Mode** A resolution setting that uses varying shades of grey for the best representation of photographs.
- Polling** The process of a fax machine calling another fax machine to retrieve waiting fax messages.
- Pulse** A form of dialling on a telephone line.
- Quick-Dial List** A listing of names and numbers stored in One Touch and Speed Dial memory, in numerical order.
- Real Time transmission** When memory is full, you can send documents in real time.
- Remaining Jobs** You can check which jobs are waiting in memory and cancel jobs individually.
- Remote access** The ability to access the machine remotely from a touch tone phone.

- Remote activation** allows you to transfer a fax call, answered at an extension phone, to the machine.
- Remote access code** The four-digit code that allows you to call and access the machine from a remote location.
- Resolution** The number of horizontal and vertical lines per inch.
- Ring Delay** The number of telephone rings before the machine answers a call in Fax/Tel (F/T) or Fax Only Mode.
- Ring Volume** Volume setting for the fax machine's ring.
- Scanning** The process of sending an electronic image of an original paper document into your computer.
- Search** You can search for names you have stored in One Touch and Speed Dial memories.
- Speaker Volume** You can set the volume of the machine speaker.
- Speed dial** A preprogrammed number for easy dialling. You must press the **Search/Speed Dial** key and #, then three digit code to start the dialling process.
- Standard resolution** 203 x 98 dpi. It is used for regular size text and quickest transmission.
- Station ID** The stored information that appears on the top of faxed pages. It includes the sender's name and fax number.
- Super fine resolution** 203 x 391 dpi. Best for very small print and line art.
- System Setup List** A printed report that shows the current setting of the machine.
- Temporary Setting** You can select certain options for each fax transmission or copy without changing the default settings.
- Timer** A feature that lets you program a fax to go out at a certain time, such as Delayed Fax or Delayed Polling Receive.
- Tone** A form of dialling on the telephone line used for Touch Tone telephones.
- Toner cartridge** An accessory that holds toner for the drum unit on Brother laser models.
- Toner Save** A process that causes less toner to be affixed to the page to extend the life of the toner assembly. This will make the receiving document significantly lighter.
- Transmission** The process of sending documents over the phone lines from the machine to the receiving fax machine.
- Xmit Report (Transmission Report)** A listing of each transmission, showing date, time, and number of pages.

Index

The items in the upper case represent LCD messages.

A	
Accessories	93
Activation Code	43
Answering Machine	6
Auto Reduction	28
Automatic Document Feeder (ADF)	1
Automatic Transmission	2, 23
B	
Beeper Volume	15
Broadcasting	38
BT Call Sign	44
C	
Chain Dialling	22
CHANGE DRUM SOON	61, 80
CHANGE TONER	61, 76
CHECK PAPER	61
CHECK PAPER SIZE	61
Cleaning (Drum Unit)	75
Cleaning (Printer)	74
Cleaning (Scanner)	73
Clock Change	16
COMM.ERROR	61
Connect (External Telephone Answering Machine)	6
Connect (External Telephone)	7
Contrast	21
Control Panel Overview	8
COOLING DOWN	61
Copy (2in1/4in1)	56
Copy (Enlarging/Reducing)	54
Copy (Sort)	55
Copy Contrast	58
Copy Mode	58
Copy Operations	52
Copy Quality	53, 57
Corrections	94
COVER OPEN	61
Cover Page Message	36
D	
Date and Time	14
Deactivation Code	43
Delayed Batch Transmission	37
Dialling a Number	22
Dialling Mode (Tone/Pulse)	18
Difficulty	66
Document (Size)	1
Document Jam	63
Drum Unit (Replacing)	80
Dual Access	24
E	
ECM (Error Correction Mode)	95
Entering Text	94
Error Messages	61
Extension Telephone	5, 43
External Telephone	7, 43
External Telephone Answering Device (TAD)	6
F	
F/T (Fax/Tel) Ring Time	26
F/T Ring Time	43
Fax Detect	27
Fax Forwarding	48
Fax Storage	48

Fax Tones and Handshake	95
Fine (Resolution)	21
Function Selection Table	10

G

Glossary	96
Grey Scale	90

H

Help	iii, 34
------------	---------

I

Important Safety Instructions	83
Inserting Spaces	94
International Calls	37

J

Job Cancel	40
JOURNAL	34
Journal Period	33

L

Lower Tray	18
------------------	----

M

Maintenance	61
Manual Dialling	30
Memory Security	40
Memory Storage	4
Menu Mode	10
Menu Selection Table	10
Multi-Line Connections	4

N

NO RESPONSE/BUSY	62
NOT ASSIGNED	62

O

One Touch Dial (Changing)	20
One Touch Dial (Storing)	19
One Touch Dialling	22
On-Screen Programming	iv
Options	9
Options Key	55
Order Form	34
OUT OF MEMORY	53
Outgoing Message of external TAD	7
Overseas Mode	37

P

PABX	4, 16
Packing and Shipping	70
Paper	92
Paper Jam	63
Paper Type	92
Pause	23
Photo (Resolution)	21
PLS OPEN COVER	62
Polling (Receive)	45
Polling (Transmit)	47
Power Cord	3
Power Save	17
Print a Report	34
Print Density	28
Product Description	90

Q

QUICK-DIAL (list)	34
-------------------------	----

R

Real Time Transmission	24
Receive Mode	25
Reception into Memory	29
Reduction (Printing)	28

Remote Access Code	49
Remote Code (Changing)	44
Remote Commands	50
Remote Retrieval	49
Reports	8, 33
Resolution	21
Ring Delay	26
Ring Volume	15

S

Safety Instructions	83
Scroll	10
Search	22, 30
Sleep Mode	17
Speaker Volume	15
Special Characters	94
Specifications	90
Speed Dial	19
Speed Dial (Changing)	20
Speed Dialling	22
Standard (Resolution)	21
Station ID	14
Storing Telephone number	19
SYSTEM SETUP	34

T

To change Remote Codes	44
Tone/Pulse	18
Toner Cartridge (Replacing)	76
TONER EMPTY	62
Toner Save	17
Trademarks	93
Troubleshooting	61

X

XMIT REPORT	33
XMIT VERIFY	34

Change Receive ModePress **9 8**

then for **TAD**, press **1**.
Fax/Tel (F/T), press **2**.
Fax, press **3**.

Exit Remote OperationPress **9 0**.**Change Remote Access Code**

- 1** Press **Menu**, **2**, **5**, **3**.
- 2** Enter the 3-digit number. The * cannot be changed.
- 3** Press **Set**.
- 4** Press **Stop/Exit**.

4

REMOTE ACCESS CARD**Using Remote Access Code**

- 1** Dial the machine phone number from a touch tone phone.
- 2** Enter your Remote Access Code (159*) after the beep.
- 3** The machine signals the kinds of messages received:
 - 1 long beep — Fax message(s)**
 - No beeps — no messages**
- 4** After 2 short beeps, enter a command.
- 5** Press **9 0** to reset the machine when you finish.
- 6** Hang up.

1

Remote Commands

Change Fax Forwarding Setting

Press **9 5**

then to **Turn Fax Forwarding off** press **1**.

Turn Fax Forwarding on press **2**.

Program Fax Forward Number

press **4**. Enter the new number of the remote fax machine where you want your fax message forwarded and then press **# #**.

Turn Fax Storage on press **6**.

Turn Fax Storage off press **7**.

Retrieve Fax

Press **9 6**

then to **Retrieve all faxes** press **2**, then enter the number of remote fax machine, and then **# #**. After the beep, hang up and wait.

Erase all fax messages press **3**.

Check the Receiving Status

Press **9 7 1**.

1 long beep — Fax message(s)

3 short beeps — no messages

At your side.
brother®

This machine is approved for use in the country of purchase only, local Brother companies or their dealers will only support machines purchased in their own countries.