



KONICA MINOLTA

bizhub 4752/4052 **QUICK GUIDE**





Table of contents

1 Introduction

1.1	Introduction	1-3
	Environmental initiatives	1-3
	ENERGY STAR®	1-4
	What is an ENERGY STAR® Product?	1-4
	Environmental benefits of power management	1-4
	Recycled Paper	1-4
	Duplex printing	1-4
1.2	Safety information	1-5
	Warning and precaution symbols	1-5
	These are some of major exemplary graphical symbols.	1-5
	Power source connection	1-6
	Installation	1-7
	Using the product	1-8
	Consumables	1-10
1.3	Regulation notices	1-11
	CE Marking (Declaration of Conformity) for users of the European Union (EU)	1-11
	FCC Part 15 - Radio Frequency Devices	1-12
	INTERFERENCE-CAUSING EQUIPMENT STANDARD (ICES-003 ISSUE 5) (for Canada users)	1-12
	Electromagnetic Interference	1-12
	GS Certification	1-13
	Laser Safety	1-13
	Internal Laser Radiation	1-13
	CDRH regulations	1-13
	For European users	1-13
	Laser safety label	1-14
	Ozone Release	1-14
	Changing replaceable lithium batteries used in products	1-14
	Acoustic noise (for European users only)	1-15
	Notification for California Customers	1-15
	Recycling batteries (for Taiwan users only)	1-15
	For EU member states only	1-15
	USB Host	1-15
	Graphic symbols used on this machine	1-16
1.4	Caution notations and labels	1-17
1.5	Special Notice to User	1-18
	For Canada	1-18
	For U.S.A.	1-18
	For Europe	1-19
1.6	Space requirements	1-20
1.7	Operation precautions	1-21
	Power source	1-21
	Operating environment	1-21
	Storage of copies	1-21
	Data stored in this machine	1-21
	Precautions for Carrying the Machine	1-22
1.8	Legal restrictions on reproduction	1-23
1.9	Trademark acknowledgements	1-24
	Copyright	1-25
	Note	1-25
1.10	Software End User License Agreement	1-26

2 User's Guides

2.1	Intended use of office MFP devices	2-3
	Intended use	2-3
	Impermissible operating conditions.....	2-3
	Exclusion of liability.....	2-3
2.2	Introduction to user's guide	2-4
2.2.1	User's Guide CD/DVD.....	2-4
	Layout of top page.....	2-4
	Operating environment	2-5
2.2.2	Target groups.....	2-5
2.2.3	Symbols and notations used in this manual	2-5
	Procedural instruction.....	2-5
	Symbols and notations	2-6
	Names and notations of applications	2-6

3 Overview of This Machine

3.1	About this machine	3-3
3.1.1	Name of parts	3-3
	Front.....	3-3
	Side/rear.....	3-4
3.1.2	Option configuration	3-5
	List of optional components	3-5
	List of other optional components.....	3-6
3.2	Power Supply	3-7
3.2.1	Power Switch and Power key locations.....	3-7
3.2.2	Turning the Power Switch ON or OFF	3-8
3.2.3	Using the Power key	3-8
	When using the Power key as a Power Save key.....	3-9
	When using the Power key as a Sub Power Off key.....	3-9
3.3	Control Panel	3-10
3.4	Operating the Touch Panel	3-12
	Tap	3-12
	Double-tap	3-12
	Flick.....	3-12
	Drag	3-13
	Pan.....	3-13
	Long-tap	3-13
	Drag & Drop	3-14
	Pinch-in / Pinch-out.....	3-14
	Rotation.....	3-15
	Displaying the Keypad	3-15
	Moving the Keypad.....	3-15
	Switching to the entry or selection screen.....	3-16
	Precautions on using the Touch Panel	3-16
3.5	Main Menu	3-17
3.6	Entering characters	3-19

4 Loading Paper

4.1	Paper	4-3
4.1.1	Confirm the available paper types	4-3
4.1.2	Confirm the available paper sizes.....	4-4
4.1.3	Precautions for Correct Operations	4-4
	Unavailable paper	4-4
	Storing paper	4-5
4.2	Loading Paper in Bypass Tray	4-6
	How to load paper into the Bypass Tray	4-6
4.3	Loading paper into Tray 1	4-8



5 Initial Settings of This Machine

5.1	Preparation for network connection (for administrators)	5-3
	Checking a LAN cable for connection	5-3
	Assigning an IP address	5-3
5.2	Preparation for fax (for administrators)	5-4
	Checking the modular cable connection	5-4
	Specifying the type of telephone line.....	5-4
	Making preparations for using the machine in a Private Branch Exchange (PBX) environment	5-4
	Selecting a receiving method.....	5-4
	Registering the sender information.....	5-4
	Set the date and time for the machine.....	5-4
5.3	Security settings (for administrators)	5-5
5.3.1	Hard Disk setting	5-5
5.3.2	Configuring [Quick Security Setting].....	5-5
5.4	Administrator Password	5-6

6 Basic Usage

6.1	Using the print function (Windows environment)	6-3
6.1.1	Printer driver.....	6-3
6.1.2	Preparation for printing (network connection)	6-3
	Checking the LAN cable connection	6-3
	Checking the network settings	6-3
	Installing the printer driver	6-4
6.1.3	Preparation for printing (USB connection)	6-5
	Changing the installation settings (Windows 7/8.1/10/Server 2008 R2/Server 2012/Server 2012 R2/Server 2016).....	6-5
	Installing the printer driver	6-6
6.1.4	Initial settings of the printer driver	6-7
6.1.5	How to print	6-7
6.2	Using the scan function	6-8
6.2.1	Available operations in the scan function	6-8
6.2.2	How to send.....	6-9
6.3	Using the fax function	6-11
6.3.1	Fax function	6-11
6.3.2	How To Send	6-12
6.3.3	Introduction of fax transmission function	6-13
6.3.4	Introduction of fax receiving function	6-14
6.3.5	Introduction of internet fax function.....	6-14
6.3.6	Introduction of IP address fax function.....	6-14
6.4	Using the copy function	6-15
6.4.1	How to copy.....	6-15
6.4.2	Introduction of copy function.....	6-17
6.5	Printing a file stored on USB memory	6-19
	Supported USB memory devices	6-19
	How to print	6-19
6.6	Registering a destination	6-21
6.6.1	Address book.....	6-21
6.6.2	Registering address books	6-21
	Registering from the Utility	6-21
	Registering from Address Book.....	6-25
	Registering from the Fax/Scan basic screen.....	6-26

7 Index





Introduction

1 Introduction

1.1 Introduction

This [Quick Guide] uses illustrations to describe operating procedures for the most commonly used functions in an easy-to-understand way.

Start by using this manual to become proficient with the useful functions that this machine offers.

For details on the various functions, refer to the User's Guides on the User's Guide CD/DVD included with this machine.

In order to operate the machine safely and properly, be sure to read the safety information on page 1-5 of this manual before use.

In addition, this manual contains the following information. Be sure to read the manual before using the machine.

- Items that must be observed to use the machine safely
- Information regarding product safety
- Precautions when using the machine
- Descriptions on trademarks and copyrights

The illustrations and screens used in this manual may appear slightly different from views of the actual equipment and screens.

Tips

- Please keep this manual as well as the attached CD/DVD in a safe place where you can access them easily.

Environmental initiatives

The company continuously strives to reduce the negative environmental impacts of all stages of its business operations.

As part of such activities, the company is implementing resource-saving steps by reducing the number of pages in the User's Guide.

For the information necessary to operate the machine, please refer to the bundled User's Guide CD/DVD (HTML format). This guide has an excellent search function.

Functions such as keyword search and filtering by purpose are very useful to help users find what they need to know.

ENERGY STAR®



As an ENERGY STAR® Partner, this machine meets the ENERGY STAR® Guidelines for energy efficiency.

What is an ENERGY STAR® Product?

An ENERGY STAR® product has a special feature that allows it to automatically switch to a "low-power mode" after a period of inactivity. An ENERGY STAR® product uses energy more efficiently, saves you money on utility bills and helps protect the environment.

Environmental benefits of power management

Electricity consumption of a device depends on both its properties and the way of using the device.

Suitable power management setting offers you resource saving usage way. By setting the time to go into power saving modes (e.g. sleep mode) shorter (or optimal), electricity consumption can be reduced.

Recycled Paper

This product can print on recycled paper and environmental stewardship initiatives certified paper which complies with European standard EN 12281 as well as virgin paper. In addition it can print on lighter paper, 64g/m² for example. Using such light paper contributes to resources-saving.

Duplex printing

With a product which has a duplex unit, you can print on both sides of paper automatically.

Using this function leads to reducing consumption of natural resources and your cost.

Attached printer driver provides this duplex printing function as initial setting in your computer (The setting can be changed after installation manually).

1.2 Safety information

This section contains detailed instructions on the operation and maintenance of this machine. To achieve optimum utility of this device, all operators should carefully read and follow the instructions in this manual.

Please read the following section before connecting the machine to the supply. It contains important information related to user safety and preventing equipment problems.

Make sure that you observe all of the precautions that appear in different sections of this manual.

Reference



- Some parts of the contents of this section may not correspond with the purchased product.

Warning and precaution symbols









Be sure to observe the safety precautions.

This manual contains the instructions that should be strictly observed at all times to prevent injury to yourself and other persons as well as damage to property.

Injuries and damage that might be caused by using the product improperly are classified according to the following symbols.









Pictorial indication	Description
 WARNING	Improper handling can cause serious injury or death.
 CAUTION	Improper handling can cause minor injury or damage to houses and property.

These are some of major exemplary graphical symbols.



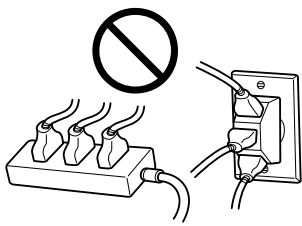
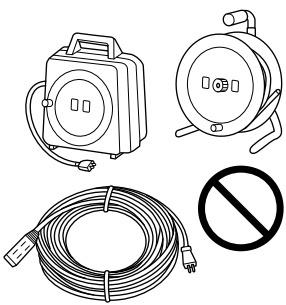

Graphic symbols	Descriptions	Graphic symbols	Descriptions	Graphic symbols	Descriptions
	General prohibition		Do not disassemble		Do not touch
	General instruction		Ground/Earth		Unplug from outlet
	General precaution		High temperature		Electrical shock hazard

Power source connection

WARNING

Descriptions	Graphic symbols
<p>Do not use any power cord other than the one supplied in the package or attached on the products. If a power cord is not supplied, use only the power cord and plug that are specified in the user documentation. Failure to use this cord could result in a fire or electrical shock. If the power cord supplied in the package cannot be used in the country where this product was sold, use a power cord that meets the following conditions or contact your Technical Representative.</p> <ul style="list-style-type: none"> • The power cord has voltage and current rating appropriate for the rating plate on this machine. • The power cord meets regulatory requirements for the area. • The power cord is provided with grounding pin/terminal. 	
<p>Do not use the power cord to other products. Failure to do that could result in a fire or electrical shock.</p>	
<p>Do not scratch, abrade, place a heavy object on, heat, twist, bend, step on, pull on, or damage the power cord. Use of a damaged power cord (exposed core wire, broken wire, etc.) could result in a fire or breakdown. Should any of these conditions be found, immediately turn OFF the power switch, unplug the power cord from the power outlet, and then call your authorized service representative.</p>	
<p>Do not use the power source voltage other than being specified on the machine. Failure to do that could result in a fire or electrical shock.</p>	
<p>Do not use a multiple outlet adapter to connect any other appliances or machines. Use of a power outlet for more than the marked current value could result in a fire or electrical shock.</p>	
<p>Do not use an extension cord. Use of an extension cord could cause a fire or electric shock. If the power cord furnished with the product is not long enough to be plugged into a wall outlet, contact your Technical Representative.</p>	
<p>Do not unplug and plug in the power cord with a wet hand, as an electrical shock could result.</p>	
<p>Plug the power cord all the way into the power outlet. Failure to do this could result in a fire or electrical shock.</p>	
<p>Make sure to ground this product. (Connect the power cord to an electrical outlet that is equipped with a grounding terminal.) Failure to do so and an unlikely event of leakage could result in a fire or electrical shock.</p>	

⚠ CAUTION





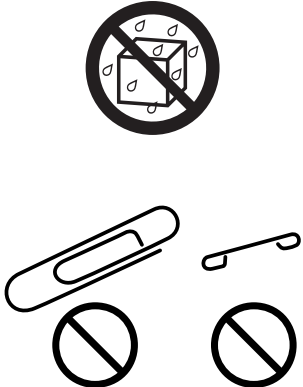
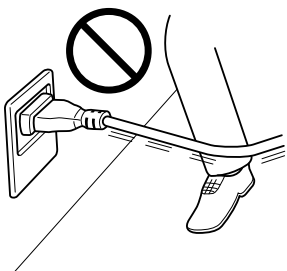

Descriptions	Graphic symbols
The outlet must be near the equipment and easily accessible. Otherwise you can not pull out the power plug when an emergency occurs.	
Do not place any objects around the power plug, as the power plug may be difficult to pull out when an emergency occurs.	
Do not tug the power cord when unplugging. Pulling on the power cord could damage the cord, resulting in a fire or electrical shock.	
Remove the power plug from the outlet more than one time a year and clean the area between the plug terminals. Dust that accumulates between the plug terminals may cause a fire.	

Installation





⚠ WARNING

Descriptions	Graphic symbols
Keep this bag away from babies and children. Do not use in cribs, beds, carriages, or playpens. The thin film may cling to nose and mouth and prevent breathing. This bag is not a toy.	
Do not place a flower vase or other container that contains water, or metal clips or other small metallic objects on this product. Spilled water or metallic objects dropped inside the product could result in a fire, electrical shock, or breakdown. Should a piece of metal, water, or any other similar foreign matter get inside the product, immediately turn OFF the power switch, unplug the power cord from the power outlet, and then call your Technical Representative or your authorized service representative.	
Make sure that the power cord is placed on a site in which no person would step on or trip over it. Stepping on or tripping over the power cord could heat the power cord, resulting in a fire or electric shock.	

⚠ CAUTION

Descriptions	Graphic symbols
<p><If instructed to use fixing legs> When the product has been installed, fix the product using the fixing legs. Not using the fixing legs could cause the product to move or topple over.</p>	
<p>Do not place the product in a dusty place, or a site exposed to soot or steam, near a kitchen table, bath, or a humidifier. A fire, electrical shock, or breakdown could result.</p>	
<p>Do not place this product on an unstable or tilted bench, or in a location subject to a lot of vibration and shock. It could drop or fall, causing personal injury or mechanical breakdown.</p>	
<p>Do not let any object plug the ventilation holes of this product. Heat could accumulate inside the product, resulting in a fire or malfunction.</p>	
<p>Whenever moving this product, be sure to disconnect the power cord and other cables. Failure to do this could damage the cord or cable, resulting in a fire, electrical shock, or breakdown.</p>	
<p>When moving this product, always hold it at the locations specified in the User's Guide or other documents. If the unit is moved while held at locations other than those specified, it may fall, causing severe personal injury.</p>	

Using the product**⚠ WARNING**

Descriptions	Graphic symbols
<p>Do not modify this product, as a fire, electrical shock, or breakdown could result. If the product employs a laser, the laser beam source could cause blindness.</p>	
<p>Do not attempt to remove the covers and panels which have been fixed to the product. Some products have a high-voltage part or a laser beam source inside that could cause an electrical shock or blindness.</p>	
<p>Do not keep using this product, if this product becomes inordinately hot or emits smoke, or unusual odor or noise. Immediately turn OFF the power switch, unplug the power cord from the power outlet, and then call your Technical Representative or your authorized service representative. If you keep on using it as is, a fire or electrical shock could result.</p>	
<p>Do not keep using this product, if this product has been dropped or its cover damaged. Immediately turn OFF the power switch, unplug the power cord from the power outlet, and then call your Technical Representative or your authorized service representative. If you keep on using it as is, a fire or electrical shock could result.</p>	
<p>Do not use flammable sprays, liquids, or gases inside or near this machine. Do not clean the inside of this machine using a flammable gas duster. A fire or explosion could result.</p>	

⚠ WARNING

Descriptions

Graphic symbols

<If an RFID module (limited only to 13.56 MHz) for use in inside-the-machine proximity communication or electromagnetic induction heating (IH) technology (limited only to 20.05 kHz to 100 kHz) is being used>
 This machine generates a weak magnetic field.
 If you experience any unusual symptoms with your implantable medical equipment (cardiac pacemaker, etc.) while near the machine, move away from the machine and see a doctor immediately.
 Please call your Technical Representative or your authorized service representative if you do not understand the purchased product corresponds or not.



<If a non-contact IC card reader is being used>
 If you use an implantable medical equipment (cardiac pacemaker, etc.), do not bring the IC card reader close from the implant within 12 cm at all times.
 The radio waves may affect implantable medical equipment (cardiac pacemaker, etc.) operations.



⚠ CAUTION

Descriptions

Graphic symbols

Using this product in a poorly ventilated room for a long time or producing a large volume of copies or prints may cause the odor of exhaust air from the machine. Ventilate the room well.



The inside of this product has areas subject to high temperature, which may cause burns.
 When checking the inside of the unit for malfunctions such as a paper misfeed, do not touch the locations (around the fusing unit, etc.) which are indicated by a "Caution HOT" caution label. A burn could result.



Unplug the product when you will not use the product for long periods of time.



When using the machine, do not look at the light of the lamp for a prolonged time. Eyestrain could result.



Do not use stapled paper, conductive paper (such as silver paper or carbon paper) or treated heat-sensitive/inkjet paper, otherwise a fire may result.



Consumables

WARNING

Descriptions

Do not throw toner or a container that contains toner (e.g., toner cartridge, developing unit and Waste Toner Box) into an open flame. The hot toner may scatter and cause burns or other damage.

Graphic symbols



CAUTION

Descriptions

Do not leave toner-related parts (e.g., toner cartridge, developing unit and Waste Toner Box) within easy reach of children. Licking any of these parts or ingesting toner could damage your health.

Graphic symbols



Do not store toner-related parts (e.g., toner cartridge, developing unit and Waste Toner Box) near devices susceptible to magnetism, such as precision equipment and data storage devices, otherwise they may malfunction. They could cause these products to malfunction.



Do not force open the toner-related parts (e.g., toner cartridge, developing unit and Waste Toner Box). If toner tumbles from the toner bottle, take utmost care to avoid inhaling it or even getting skin contact.



If toner lands on your skin or clothing, wash thoroughly with soap and water.



If you inhale toner, move to a place with fresh air and gargle with a lot of water repeatedly. Should you get symptoms such as coughing, seek medical advice.



If you get toner into your eyes, immediately rinse them with running water for over 15 minutes. Seek medical advice if irritation persists.



If you swallow toner, rinse out your mouth and drink a few glasses of water. Seek medical advice if necessary.



Never touch the electrical contacts of the units (e.g., toner cartridge and developing unit), as an electrostatic discharge may damage the product.



Before handling, see the user documentation for the safety information.



<If instructed to replace the fusing unit>

The fusing section is extremely hot. Before replacing the fusing unit, be sure to open doors and covers of the machine. Then, leave the machine to stand idle for a specified period of time and make sure that the fusing section has cooled down to room temperature. Failure to follow these instructions could result in a burn.



1.3 Regulation notices

CE Marking (Declaration of Conformity) for users of the European Union (EU)

Hereby, Konica Minolta declares that the radio equipment types mentioned on the front cover of this manual or/and in clause 1.2 are in compliance with Directive 2014/53/EU.

The full text of the EU declaration of conformity is available at the following internet address:

"<https://www.konicaminolta.eu/en/business-solutions/support/download-center.html>".

Choose your product and open the section "Safety Documents".

Maximum radio-frequency power transmitted in the frequency band (EIRP):

Module Name, Option	Frequency Band	Radiation Power
UK-216 includes approved Wireless module, MODEL DAUB-KM66:	2.4 GHz	Max. 20 dBm
	5 GHz	Max. 23 dBm
EK-P06 includes approved Wireless module, MODEL MBH7BLZ02:	2.4 GHz	Max. 3 dBm
AU-201S Authentication Unit:	13.56 MHz	Max. -27 dBm

Note: 5 GHz may not be available

This radio equipment is restricted to indoor use only. Outdoor use is prohibited.

This restriction applies to all the countries listed in the table below.



AT	BE	BG	CH	CY	CZ	DE	DK	EE
EL	ES	FI	FR	HR	HU	IE	IS	IT
LI	LT	LU	LV	MT	NL	NO	PL	PT
RO	SE	SI	SK	TR	UK			

FCC Part 15 - Radio Frequency Devices

For United States Users

FCC: Declaration of Conformity

Product Type	Multifunction Printer
Product Name	bizhub 4752, bizhub 4052
Options	(1) FS-P02, PF-P15, PF-P16, EK-P05, EK-P06, EK-P07, KP-101, AU-102, AU-201S, FK-517, LK-102 v3, LK-104 v3, LK-106, LK-107, LK-108, LK-111, LK-114, LK-115 v2, SK-501, DK-P02, UK-219---- (for bizhub 4752) (2) FS-P02, PF-P15, PF-P16, EK-P05, EK-P06, EK-P07, KP-101, AU-102, AU-201S, FK-517, LK-102 v3, LK-104 v3, LK-106, LK-107, LK-108, LK-111, LK-114, LK-115 v2, SK-501, DK-P02, UK-219---- (for bizhub 4052)

This device complies with Part 15 of the FCC Rules

Operation is subject to the following two conditions:

- (1) This device may not cause harmful interference, and
- (2) this device must accept any interference received, including interference that may cause undesired operation.

NOTE:

This equipment has been tested and found to comply with the limits for a Class B digital device, pursuant to Part 15 of the FCC Rules. These limits are designed to provide reasonable protection against harmful interference in a residential installation. This equipment generates, uses and can radiate radio frequency energy and, if not installed and used in accordance with the instructions, may cause harmful interference to radio communications. However, there is no guarantee that interference will not occur in a particular installation. If this equipment does cause harmful interference to radio or television reception, which can be determined by turning the equipment off and on, the user is encouraged to try to correct the interference by one or more of the following measures:

- Reorient or relocate the receiving antenna.
- Increase the separation between the equipment and receiver.
- Connect the equipment into an outlet on a circuit different from that to which the receiver is connected.
- Consult the dealer or an experienced radio/TV technician for help.

⚠ WARNING

- The design and production of this unit conform to FCC regulations, and any changes or modifications must be registered with the FCC and are subject to FCC control. Any changes made by the purchaser or user without first contacting the manufacturer will be subject to penalty under FCC regulations.
- This device must be used with a shielded interface cable. The use of non-shielded cables is likely to result in interference with radio communications and is prohibited under FCC rules.

INTERFERENCE-CAUSING EQUIPMENT STANDARD (ICES-003 ISSUE 5) (for Canada users)

This Class B digital apparatus complies with Canadian ICES-003.

Cet appareil numérique de la classe B est conforme à la norme NMB-003 du Canada.

This device must be used with a shielded interface cable.

The use of non-shielded cables is likely to result in interference with radio communications and is prohibited under ICES-003.

Electromagnetic Interference

This product must be used with a shielded interface cable.

The use of non-shield cables is likely to result in interference with radio communications and is prohibited under CISPR 22 and local rules.

GS Certification

This device is not intended for use in the direct field of view at visual display workplaces. To avoid incoming reflexions at visual display workplaces this device must not be placed in the direct field of view.

Das Gerät ist nicht für die Benutzung im unmittelbaren Gesichtsfeld am Bildschirmarbeitsplatz vorgesehen. Um störende Reflexionen am Bildschirmarbeitsplatz zu vermeiden, darf dieses Produkt nicht im unmittelbaren Gesichtsfeld platziert werden.

Laser Safety

This is a digital machine which operates using a laser. There is no possibility of danger from the laser provided the machine is operated according to the instructions in the manuals.

Since radiation emitted by the laser is completely confined within protective housing, the laser beam cannot escape from the machine during any phase of user operation.

This machine is certified as a Class 1 laser product per IEC 60825-1: 2014: This means the machine does not produce hazardous laser radiation.

Internal Laser Radiation

Maximum average radiation power: 19.8 μ W at the laser aperture of the print head unit.

Wavelength: 650-670 nm

This product employs a Class 3B laser diode that emits an invisible laser beam.

The laser diode and the scanning polygon mirror are incorporated in the print head unit.

The print head unit is NOT A FIELD SERVICE ITEM:

Therefore, the print head unit should not be opened under any circumstances.

CDRH regulations

This machine is certified as a Class 1 Laser product under Radiation Performance Standard according to the Food, Drug and Cosmetic Act of 1990. Compliance is mandatory for Laser products marketed in the United States and is reported to the Center for Devices and Radiological Health (CDRH) of the U.S. Food and Drug Administration of the U.S. Department of Health and Human Services (DHHS). This means that the device does not produce hazardous laser radiation.

The label shown on page 1-14 indicates compliance with the CDRH regulations and must be attached to laser products marketed in the United States.

⚠ WARNING

Use of controls, adjustments or performance of procedures other than those specified in this manual may result in hazardous radiation exposure.

- This is a semiconductor laser. The maximum power of the laser diode is 15 mW and the wavelength is 650-670 nm.
-

For European users

⚠ WARNING

Use of controls, adjustments or performance of procedures other than those specified in this manual may result in hazardous radiation exposure.

- This is a semiconductor laser. The maximum power of the laser diode is 15 mW and the wavelength is 650-670 nm.
-

Laser safety label

A laser safety label is attached to the outside of the machine, as shown below.

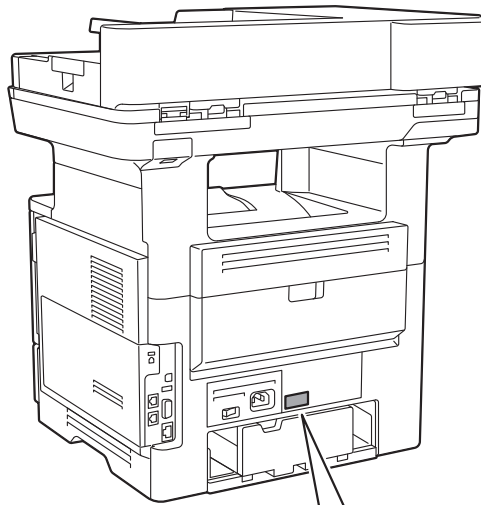

complies with 21CFR 1040.10 and 1040.11
except for deviations pursuant to laser notice no. 50,
dated June 24, 2007.
or/and

CLASS 1 LASER PRODUCT
LASER KLASSE 1 PRODUKT
APPAREIL À LASER DE CLASSE 1
PRODUCTO LASER DE CLASE 1
1등급레이저 제품

Ozone Release

Locate the Machine in a Well-Ventilated Room

A negligible amount of ozone is generated during normal operation of this machine. An unpleasant odor may, however, be created in poorly ventilated rooms during extensive machine operations. For a comfortable, healthy and safe operating environment, it is recommended that the room be well ventilated.

Placer l'appareil dans une pièce largement ventilée

Une quantité d'ozone négligable est dégagée pendant le fonctionnement de l'appareil quand celui-ci est utilisé normalement. Cependant, une odeur désagréable peut être ressentie dans les pièces dont l'aération est insuffisante et lorsque une utilisation prolongée de l'appareil est effectuée. Pour avoir la certitude de travailler dans un environnement réunissant des conditions de confort, santé et de sécurité, il est préférable de bien aérer la pièce où se trouve l'appareil.

Changing replaceable lithium batteries used in products

⚠ CAUTION

- RISK OF EXPLOSION IF BATTERY IS REPLACED BY AN INCORRECT TYPE. DISPOSE OF USED BATTERIES ACCORDING TO THE USER'S GUIDE.

Acoustic noise (for European users only)

Der höchste Schalldruckpegel beträgt 70 dB(A) oder weniger gemäß EN ISO 7779.

Notification for California Customers

This product uses a CR Lithium Battery which contains perchlorate material.

This perchlorate warning applies to perchlorate-containing lithium batteries sold or distributed in California, USA.

"Perchlorate Material - Special handling may apply, See www.dtsc.ca.gov/hazardouswaste/perchlorate."

Recycling batteries (for Taiwan users only)

根據地方規定處理使用的電池。



This symbol means: Do not dispose of this product together with your household waste!

Please refer to the information of your local community or contact our dealers regarding the proper handling of end-of-life electric and electronic equipments. Recycling of this product will help to conserve natural resources and prevent potential negative consequences for the environment and human health caused by inappropriate waste handling.



For EU member states only















This product complies with RoHS (2011/65/EU) Directive.

USB Host

Connect USB devices (Memory, Authentication, Hub etc.) devices directly to the USB host. If an extension cable is used, electromagnetic interference could occur.

Graphic symbols used on this machine

These are some of major exemplary graphical symbols.

Graphic symbols	Descriptions	Graphic symbols	Descriptions	Graphic symbols	Descriptions
	"ON" position		"OFF" position		STAND-BY
	push-push type switches		Ground/Earth (Protective bonding terminal)		Ground/Earth (Protective earthing)
	CLASS II EQUIPMENT		Class II equipment with functional earthing		Functional earthing
	General precaution		High temperature		Electrical shock hazard
	CAUTION moving fan blade		CAUTION DOUBLE POLE / NEUTRAL FUSING		

1.4 Caution notations and labels

Safety precaution notations and labels appear on this machine at the following positions. Be very careful that an accident does not occur when operations such as removing paper jams and staple jams are performed.

⚠ WARNING

Do not burn used toner cartridges. Toner expelled from the fire is dangerous.

⚠ CAUTION

The area around the fusing unit is extremely hot. Touching any part other than those indicated may result in burns.

⚠ WARNING

Do not burn the used imaging unit. Toner expelled from the fire is dangerous.

⚠ CAUTION

The area around the fusing unit is extremely hot. Touching any part other than those indicated may result in burns.

⚠ CAUTION

- Do not remove caution labels or notations. If any caution label or caution notation is soiled, please clean to make legible. If you cannot make them legible, or if the caution label or notation is damaged, please contact your service representative.

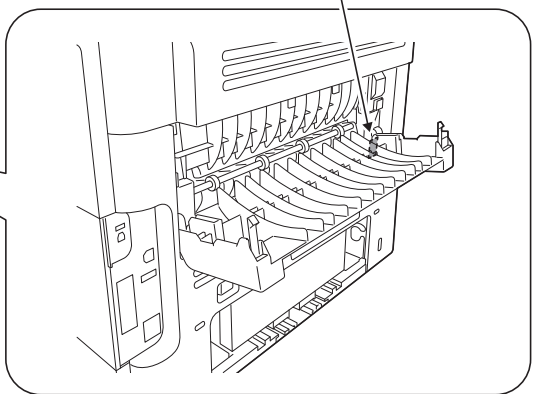
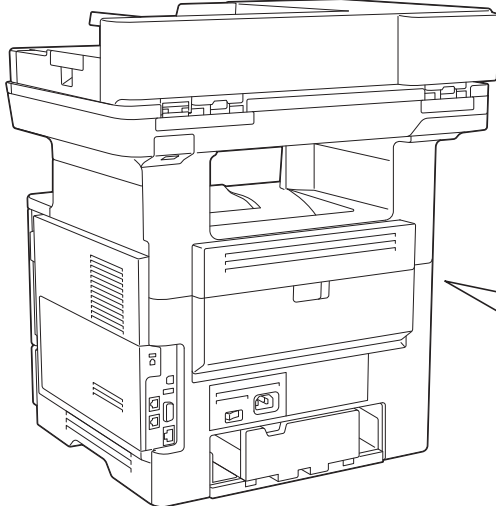
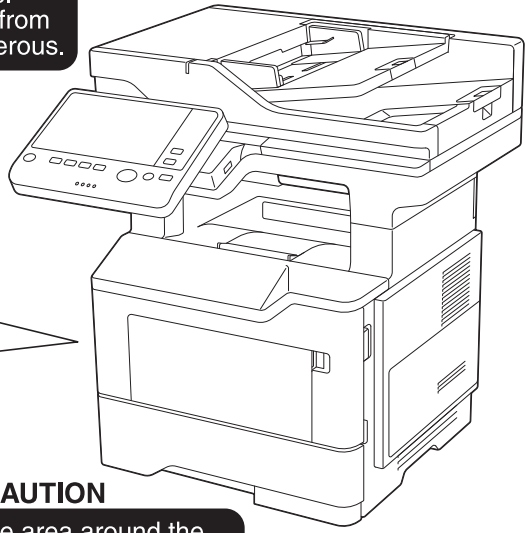
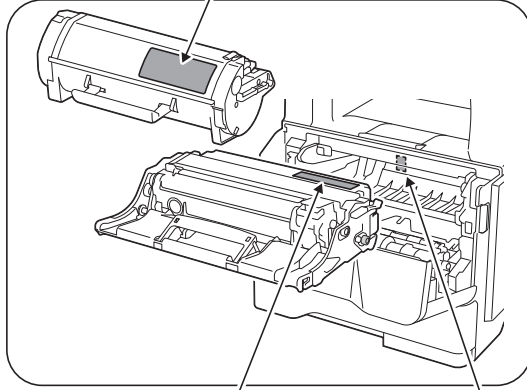

- Do not remove caution labels or notations. If any caution label or caution notation is soiled, please clean to make legible. If you cannot make them legible, or if the caution label or notation is damaged, please contact your service representative.

1.5 Special Notice to User

For Canada

This product meets the applicable Innovation, Science and Economic Development Canada technical specifications.

Le présent produit est conforme aux spécifications techniques applicables d'Innovation, Sciences et Développement économique Canada.

The Ringer Equivalence Number (REN) indicates the maximum number of devices allowed to be connected to a telephone interface. The termination of an interface may consist of any combination of devices subject only to the requirement that the sum of the RENs of all the devices not exceed five.

L'indice d'équivalence de la sonnerie (IES) sert à indiquer le nombre maximal de dispositifs qui peuvent être raccordés à une interface téléphonique. La terminaison d'une interface peut consister en une combinaison quelconque de dispositifs, à la seule condition que la somme des IES de tous les dispositifs n'exécède pas cinq.

For U.S.A.

FCC PART 68 REQUIREMENTS:

This equipment complies with Part 68 of the FCC rules and the requirements adopted by the ACTA. On the cover of this equipment is a label that contains, among other information, a product identifier in the format US:AAAEQ##TXXXX. If required, this information must be provided to the telephone company.

This equipment uses certification jack USOC RJ11C.

A plug and jack used to connect this equipment to the premises wiring and telephone network must comply with the applicable FCC Part 68 rules and requirements adopted by the ACTA.

A compliant telephone cord and modular plug is provided with this product. It is designed to be connected to a compatible modular jack that is also compliant. See installation instructions for details.

The REN is used to determine the number of devices that may be connected to a telephone line. Excessive RENs on a telephone line may result in the devices not ringing in response to an incoming call. In most but not all areas, the sum of RENs should not exceed five (5.0).

To be certain of the number of devices that may be connected to a line, as determined by the total RENs, contact the local telephone company. For products approved after July 23, 2001, the REN for this product is part of the product identifier that has the format US: AA AEQ##TXXXX. The digits represented by ## are the REN without a decimal point (e.g., 03 is a REN of 0.3). For earlier products, the REN is separately shown on the label.

If this equipment causes harm to the telephone network, the telephone company will notify you in advance that temporary discontinuance of service may be required. But if advance notice isn't practical, the telephone company will notify the customer as soon as possible. Also, you will be advised of your right to file a complaint with the FCC if you believe it is necessary.

The telephone company may make changes in its facilities, equipment, operations or procedures that could affect the operation of the equipment. If this happens the telephone company will provide advance notice in order for you to make necessary modifications to maintain uninterrupted service.

If trouble is experienced with this equipment, for repair or warranty information, please contact the Konica Minolta dealer location where you purchased this equipment. If the equipment is causing harm to the telephone network, the telephone company may request that you disconnect the equipment until the problem is resolved.

Connection to party line service is subject to state tariffs. Contact the state public utility commission, public service commission or corporation commission for information. If your home has specially wired alarm equipment connected to the telephone line, ensure the installation of this equipment does not disable you alarm equipment. If you have questions about what will disable alarm equipment, consult your telephone company or a qualified installer.

The Telephone Consumer Protection Act of 1991 makes it unlawful for any person to use a computer or other electronic device, including FAX machines, to send any message unless such message clearly contains in a margin at the top or bottom of each transmitted page or on the first page of the transmission, the date and time it is sent and an identification of the business or other entity, or other individual sending the message and the telephone number of the sending machine or such business, other entity, or individual.

(The telephone number provided may not be a 900 number or any other number for which charges exceed local or long-distance transmission charges.)

In order to program this information into your FAX machine, you should complete the following steps: See [Sending by Renaming the Sender ([Fax Header Settings])], of the User's Guide [Fax].

WARNING/CAUTION Explained

⚠ WARNING

- The exclamation point within an equilateral triangle followed by the word "Warning" is intended to alert the user to the possibility that a disregard for the warning may result in fatal hazards or critical injuries. Be sure to focus your attention on the Warning headings when reading the User's Guide.

⚠ CAUTION

- The exclamation point within an equilateral triangle followed by the word "Caution" is intended to alert the user to the possibility that a disregard for the caution may result in minor injuries or in physical damage. Be sure to focus your attention on the Caution headings when reading the User's Guide.
-

For Europe

The Facsimile has been confirmed to meet the standards (or requirements) ETSI for pan-European single terminal connection to the public switched telephone network (PSTN).

1.6 Space requirements

To ensure that machine operation, consumables replenishing, part replacement, and regular maintenance can easily be performed, adhere to the recommended space requirements detailed below.

Item	Specifications
Dimensions [W] × [D] × [H]	19-1/4 inches (489 mm) × 19 inches (482 mm) × 22-1/16 inches (561 mm) (Main unit and ADF)
Space Requirements ([W] × [D] × [H])	26-5/16 inches (669 mm) × 34-15/16 inches (886.8 mm) × 53-9/16 inches (1361 mm) * This shows the dimensions when the ADF and Bypass Tray are opened.

1.7 Operation precautions

To ensure the optimum performance of this machine, observe the precautions described below.

Power source

The power source requirements are as follows.

- Use a power source with as little voltage or frequency fluctuations as possible.
- Voltage fluctuation: Maximum + 6%/- 10%
- Frequency fluctuation: Maximum \pm 3 Hz (at 50 Hz/60 Hz)

Operating environment

The environmental requirements for correct operation of the machine are as follows.

- Temperature: 50°F (10°C) to 86°F (30°C) with fluctuations of no more than 18°F (10°C) within an hour
- Humidity: 15% to 85% with fluctuations of no more than 10% within an hour

Storage of copies

To store copies, follow the recommendation listed below.

- Copies that are to be kept for a long time should be kept where they are not exposed to light in order to prevent them from fading.
- Adhesive that contains solvent (e.g., spray glue) may dissolve the toner on copies.
- Color copies have a thicker layer of toner than normal black-and-white copies. Therefore, when a color copy is folded, the toner at the fold may peel off.

Data stored in this machine

For the machine with hard disk, it is suggested to delete all data stored in all hard disk areas using the overwrite all data function to prevent leakage of data prior to transfer or disposal of the machine, or returning of the leased machine.

For details of the overwrite all data function, refer to the User's Guide. Contact your service representative before deleting data.

It is recommended to backup HDD periodically as the measures for HDD defect. For the detail information of HDD backup, contact your service representative.

Precautions for Carrying the Machine

This machine weighs approximately 52-15/16 lb (24.0 kg), including consumables. Two people are always required to lift the machine.

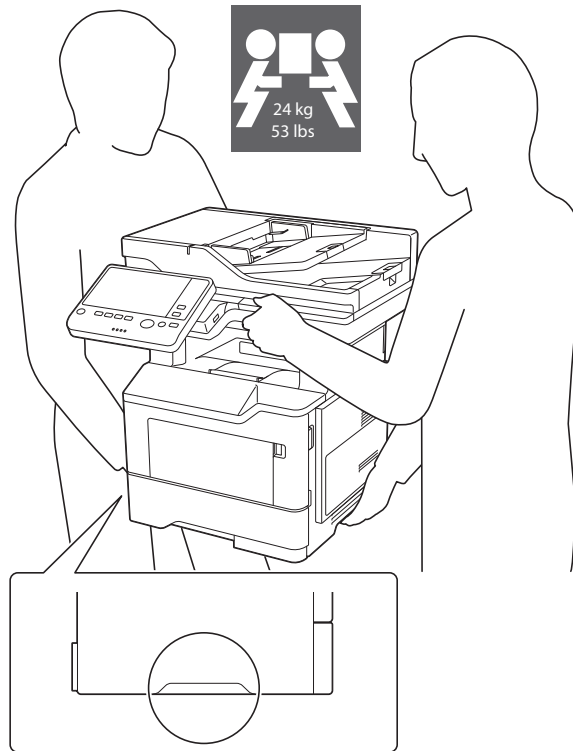

1.8 Legal restrictions on reproduction

Certain types of originals must never be reproduced with the purpose or intent to pass reproductions of such originals off as the originals.

The following is not a complete list, but is meant to be used as a guide to responsible reproduction.

<Financial Instruments>

- Personal checks
- Traveler's checks
- Money orders
- Certificates of deposit
- Bonds or other certificates of indebtedness
- Stock certificates

<Legal Originals>

- Food stamps
- Postage stamps (canceled or uncanceled)
- Checks or drafts drawn by government agencies
- Internal revenue stamps (canceled or uncanceled)
- Passports
- Immigration papers
- Motor vehicle licenses and titles
- House and property titles and deeds

<General>

- Identification cards, badges, or insignias
- Copyrighted works without permission of the copyright owner

In addition, it is prohibited under any circumstances to reproduce domestic or foreign currencies, or works of art without permission of the copyright owner.

When in doubt about the nature of an original, consult with legal counsel.

NOTICE

This machine provides the forgery prevention function in order to prevent financial instruments from being reproduced illegally.

We appreciate your understanding that printed images may infrequently have some noise or image data may not be stored under certain circumstances due to this forgery prevention function.

1.9 Trademark acknowledgements

KONICA MINOLTA, the KONICA MINOLTA logo, Giving Shape to Ideas, PageScope, and bizhub are registered trademarks or trademarks of KONICA MINOLTA, INC.

Mozilla and Firefox are trademarks of the Mozilla Foundation.

Microsoft, Windows, Windows 7, Windows 8.1, and Windows 10 are either registered trademarks or trademarks of Microsoft Corporation in the United States and/or other countries.

PowerPC is a trademark of IBM Corporation in the United States, or other countries, or both.

Citrix®, XenApp®, XenDesktop® and XenServer® are registered trademarks of Citrix Systems, Inc. and/or one or more of its subsidiaries, and may be registered in the United States Patent and Trademark Office and in other countries.

Apple, Safari, iPad, iPhone, iPod touch, Macintosh, Mac OS, OS X, macOS and Bonjour are trademarks of Apple Inc., registered in the U.S. and other countries. AirPrint and the AirPrint logo are trademarks of Apple Inc.



CUPS and CUPS logo are trademarks of Apple Inc.

Google, Google Chrome, Android, and Google Cloud Print are registered trademarks or trademarks of Google Inc.

Mopria®, the Mopria® Logo and Mopria® Alliance logo are registered trademarks and service marks of Mopria Alliance, Inc. in the United States and other countries. Unauthorized use is strictly prohibited.

Adobe, the Adobe logo, Acrobat and PostScript are either registered trademarks or trademarks of Adobe Systems Incorporated in the United States and/or other countries.

This [Sublicensee Product] contains Adobe® Reader® LE software under license from Adobe Systems Incorporated, Copyright © 1995-2009 Adobe Systems Incorporated. All rights reserved. Adobe and Reader are trademarks of Adobe Systems Incorporated.

Ethernet is a registered trademark of Xerox Corporation.

PCL is a registered trademark of Hewlett-Packard Company Limited.

This machine and PageScope Box Operator are based in part on the work of the Independent JPEG Group.

Compact-VJE

Copyright 1986-2009 Yahoo Japan Corp.

RC4® is a registered trademark or trademark of EMC Corporation in the United States and/or other countries.

RSA and BSAFE are registered trademarks or trademarks of EMC Corporation in the United States and other countries.



License information

[This product/Product name] includes RSA BSAFE® Cryptographic software from EMC Corporation.

Advanced Wnn

"Advanced Wnn"© OMRON SOFTWARE CO., Ltd. 2006 All Rights Reserved.

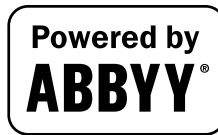

ABBYY and FineReader are registered trade marks of ABBYY Software House.

ThinPrint is a registered trademark or trademark of Cortado AG in Germany and other countries.

QR Code is a registered trademark of DENSO WAVE INCORPORATED.

Wi-Fi, the Wi-Fi CERTIFIED logo, Wi-Fi Alliance, Wi-Fi Direct, Wi-Fi Protected Setup, the Wi-Fi Protected Set-up logo, WPA, and WPA2 are either registered trademarks or trademarks of the Wi-Fi Alliance.



FeliCa is a registered trademark of Sony Corporation.

MIFARE is a registered trademark of NXP Semiconductors.

Bluetooth is a registered trademark of Bluetooth SIG, Inc.

All other product and brand names are trademarks or registered trademarks of their respective companies or organizations.

Copyright

KONICA MINOLTA, INC. maintains the copyright of the printer drivers.

© 2017 KONICA MINOLTA, INC. All Rights Reserved.

Note

User's Guide may not be reproduced in part or in full without permission.

KONICA MINOLTA, INC. will not be held liable for any incidents caused by using this printing system or User's Guide.

Information included in User's Guide is subject to change without notice.

1.10 Software End User License Agreement

PLEASE READ CAREFULLY THE LICENSE AGREEMENT BELOW BEFORE OPENING THE PACKAGE OF THIS SOFTWARE ("SOFTWARE"), DOWNLOADING, INSTALLING OR USING THE SOFTWARE. OPENING THE PACKAGE, OR DOWNLOADING, INSTALLING OR USING THE SOFTWARE SHALL BE DEEMED YOUR LAWFUL ACCEPTANCE OF THE TERMS AND CONDITIONS BELOW. IF YOU DO NOT AGREE TO THEM, DO NOT DOWNLOAD, INSTALL, USE THE SOFTWARE, NOR OPEN THE PACKAGE.

1. COPYRIGHT AND INTELLECTUAL PROPERTY RIGHTS

This is a license agreement and not an agreement for sale. KONICA MINOLTA, INC. ("KONICA MINOLTA") owns, or has been licensed from other owners ("KONICA MINOLTA Licensor"), copyrights and other intellectual property rights of the Software, and any and all rights and title to the Software and any copy made from it are retained by KONICA MINOLTA or KONICA MINOLTA Licensor. In no event, this Agreement shall be deemed to assign any copyright and/or any intellectual property rights of the Software from KONICA MINOLTA or KONICA MINOLTA Licensor to you. The Software is protected by copyright laws and international treaty provisions.

2. LICENSE

KONICA MINOLTA hereby grants to you a non-exclusive and limited license, and you may:

- (i) install and use the Software only on your computer(s) connected with a product for which this Software is designed;
- (ii) allow users of the computers described above to use the Software, provided that you assure that all such users comply with the terms of this Agreement;
- (iii) use the Software only for your own customary business or personal purpose;
- (iv) make one copy of the Software only for backup purpose in the support of the normal and intended use of the Software;
- (v) transfer the Software to other party by transferring a copy of this Agreement and all documentation along with the Software, provided that (a) you must, at the same time, either transfer to such other party or destroy all your other copies of the Software, (b) such transfer of possession terminates your license from KONICA MINOLTA, and (c) you must assure that such other party has agreed to accept the terms and conditions of this Agreement. If such other party does not accept such terms and conditions then you shall not transfer any copy of the Software.

3. RESTRICTIONS

(1) You shall not without the written consent of KONICA MINOLTA:

- (i) use, copy, modify, merge or transfer copies of the Software except as provided herein;
 - (ii) reverse engineer, reverse assemble, reverse compile or any other way analyze the Software;
 - (iii) sublicense, rent, lease or distribute the Software or any copy thereof; or
 - (iv) remove, use, or alter any trademark, logo, copyright or other proprietary notices, legends, symbols or labels in the Software.
- (2) You agree that you will not export the Software in any form in violation of any applicable laws and regulations regarding export control of any country.

4. DISCLAIMER OF WARRANTIES

(1) If the Software is furnished on CD-ROM(s) or other tangible object that is used for storage of digital data (hereinafter collectively "Storage Medium"), KONICA MINOLTA warrants the Storage Medium to be free from the defects in material and workmanship under normal use, for a period of ninety (90) days from the date of delivery to you. WITH THE EXCEPTION OF THE FOREGOING EXPRESS WARRANTIES APPLICABLE TO STORAGE MEDIUM ONLY, THE SOFTWARE IS PROVIDED TO YOU "AS IS" WITHOUT ANY WARRANTIES WHATSOEVER. KONICA MINOLTA, ITS AFFILIATE COMPANIES AND KONICA MINOLTA LICENSOR DISCLAIM ALL WARRANTIES WITH REGARD TO THE SOFTWARE, EXPRESS OR IMPLIED, INCLUDING, WITHOUT LIMITATION, IMPLIED WARRANTIES OF MERCHANTABILITY, FITNESS FOR A PARTICULAR PURPOSE AND NON-INFRINGEMENT OF THIRD PARTY RIGHTS.

(2) IN NO EVENT WILL KONICA MINOLTA, ITS AFFILIATE COMPANIES NOR KONICA MINOLTA LICENSOR BE LIABLE FOR ANY LOST PROFITS, LOST DATA, OR ANY OTHER INDIRECT, SPECIAL, PUNITIVE, INCIDENTAL OR CONSEQUENTIAL DAMAGES THAT RESULT FROM USE OR INABILITY TO USE THE SOFTWARE INCLUDING WITHOUT LIMITATION, DAMAGES FOR LOSS OF GOODWILL, COMPUTER FAILURE OR MALFUNCTION OR ANY AND ALL OTHER COMMERCIAL OR OTHER DAMAGES OR LOSSES, EVEN IF KONICA MINOLTA, ITS AFFILIATE COMPANIES OR KONICA MINOLTA LICENSOR HAS BEEN ADVISED OF THE POSSIBILITY OF SUCH DAMAGES OR FOR ANY CLAIM BY YOU BASED ON A THIRD PARTY CLAIM.

(3) The disclaimer of warranty hereunder does not affect your statutory rights. In case of the disclaimer is not allowed by applicable law, the disclaimer shall only apply to you to the maximum extent permitted by the law.

5. **TERMINATION**
You may terminate this license at any time by destroying the Software and all your copies of it. This Agreement shall also terminate if you fail to comply with any terms hereof. Upon such termination, you must immediately destroy all copies of the Software in your possession.
6. **GOVERNING LAW**
This Agreement shall be governed by the laws of Japan.
7. **SEVERABILITY**
In the event that any part or parts of this agreement shall be held illegal or null and void by any court or administrative body of competent jurisdiction, such determination shall not effect the remaining parts of this agreement and they shall remain in full force and effect as if such part or parts determined illegal or void had not been included.
8. **NOTICE TO US GOVERNMENT END USERS**
The Software is a "commercial item," as that term is defined at 48 C.F.R. 2.101 (October 1995), consisting of "commercial computer software" and "commercial computer software documentation," as such terms are used in 48 C.F.R. 12.212 (September 1995). Consistent with 48 C.F.R. 12.212 and 48 C.F.R. 227.7202-1 through 227.7202-4 (June 1995), all U.S. Government End Users shall acquire the Software with only those rights set forth herein.

Suppliers of Licensor shall be deemed third party beneficiaries of this License.

FIRMWARE UPDATES

FIRMWARE UPDATES MAY MODIFY PRINTER SETTINGS AND CAUSE COUNTERFEIT AND/OR UNAUTHORIZED PRODUCTS, SUPPLIES, PARTS, MATERIALS (SUCH AS TONERS AND INKS), SOFTWARE, OR INTERFACES TO STOP WORKING. AUTHORIZED USE OF GENUINE PRODUCTS WILL NOT BE IMPACTED.

YOU ACKNOWLEDGE THAT YOU HAVE READ THIS AGREEMENT, UNDERSTAND IT, AND AGREE TO BE BOUND BY ITS TERMS AND CONDITIONS. NEITHER PARTY SHALL BE BOUND BY ANY OTHER STATEMENTS OR REPRESENTATIONS THAT ARE INCONSISTENT WITH THE TERMS AND CONDITIONS OF THIS AGREEMENT. NO AMENDMENT TO THIS AGREEMENT IS EFFECTIVE UNLESS WRITTEN AND SIGNED BY PROPERLY AUTHORIZED REPRESENTATIVES OF EACH PARTY. BY OPENING THE PACKAGE, DOWNLOADING, INSTALLING OR USING THE SOFTWARE YOU AGREE TO ACCEPT THE TERMS OF THIS AGREEMENT.

PRINTER AGREEMENT.

Please read before opening: Opening this package, installing the printing device software, or using the products inside confirms your acceptance of these contract terms: This printer is designed to work only with genuine Konica Minolta supplies and you agree to only use genuine Konica Minolta supplies with this printer. The installed supplies inside the printer are subject to a restriction that they be used only once and returned only to Konica Minolta for remanufacturing or recycling. Supplies without this single-use term are available at www.konicaminolta.com and may be remanufactured by you, or a third-party, as the only supplies alternatives to be used with the printer.

SUPPLIES AGREEMENT.

Please read before opening: By opening this package, you accept these contract terms. The supplies inside: (1) are sold at a special price contingent upon your agreement to use the supplies only once and return the supplies only to Konica Minolta for remanufacturing or recycling after using them; and (2) will stop working after reaching end of the rated life established by Konica Minolta (a variable amount of toner may remain when replacement is required). Supplies without this single-use term are available at www.konicaminolta.com. If you do not accept these terms, return the unopened supplies to the point of purchase.

MICROSOFT CORPORATION NOTICES

1. This product may incorporate intellectual property owned by Microsoft Corporation. The terms and conditions upon which Microsoft is licensing such intellectual property may be found at <http://go.microsoft.com/fwlink/?LinkId=52369>.
2. This product is based on Microsoft Print Schema technology. You may find the terms and conditions upon which Microsoft is licensing such intellectual property at <http://go.microsoft.com/fwlink/?LinkId=83288>.



2

User's Guides

2 User's Guides

2.1 Intended use of office MFP devices

Intended use

This Multi Function Product incorporates the functionality of multiple office devices in one. It is designed to be used as an office system for the following purposes:

- Print, copy, scan and fax documents.
- Use available finishing functions such as duplexing, stapling, hole-punching and booklet creation if appropriate options are installed.
- Store scanned documents on external USB memory devices; send scanned documents to network scan destinations such as FTP, WebDAV and E-mail.

The intended use also requires that:

- The system is used within the limits of device specifications and specifications of optional components,
- All safety instructions in the related user's guides are observed,
- Legal restrictions on reproduction (see page 1-23) are observed,
- Inspection and maintenance instructions are adhered to,
- General, national and company safety provisions are observed.

Impermissible operating conditions

The system may not be operated if:

- Errors or damage have been discovered,
- Maintenance intervals have been exceeded,
- Mechanical or electrical functions do not work as they should.

Exclusion of liability

The manufacturer of the system assumes no liability for damages if the system was operated under impermissible conditions.

2.2 Introduction to user's guide

The user's guide of this product consists of this manual and the User's Guide CD/DVD.

This guide describes basic procedures required to use this machine and how to configure initial settings.

If you want to learn about more detailed functions or operation methods, refer to the User's Guide included in the User's Guide CD/DVD.

This manual also contains notes and precautions that should be followed in order to use this machine. Be sure to read "Safety information" in chapter 1 of this manual before use.

Name	Overview
Quick Guide	This manual describes basic procedures users will need to know in order to use this machine. This manual also contains notes and precautions that should be followed in order to use this machine. Please be sure to read this manual before using this machine.
User's Guide CD/DVD	This CD/DVD contains basic and detailed information on the functions of this product and also explanations of other various setting functions.

2.2.1 User's Guide CD/DVD

The User's Guide CD/DVD is provided with this machine.

Select a desired function on the top page (Home), and check the details of the function.

Selecting [Introduction] on the top page (Home) allows you to view detailed methods for using the User's Guide.

Layout of top page

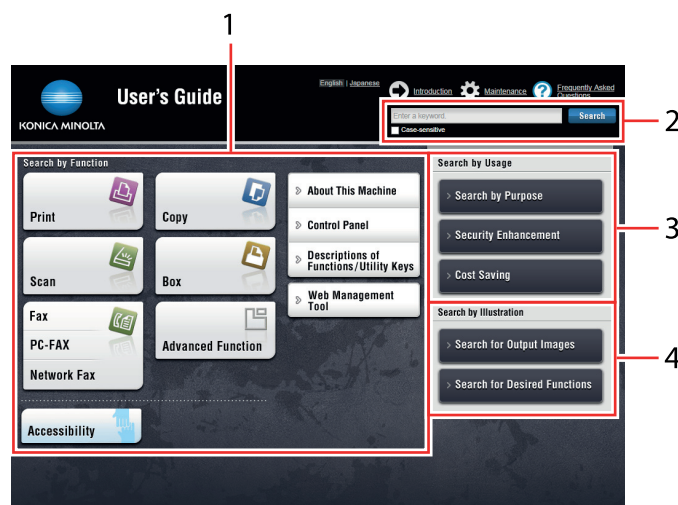

No.	Name	Description
1	[Search by Function]	Searches for desired information using functions such as printing or scanning and buttons displayed on the Touch Panel .
2	[Search]	Enter one or multiple keywords to search within the User's Guide. (Some pages are not targeted for searching.)
3	[Search by Usage]	Searches for the required operations of this machine based on the request format of "wanting to do something". This function also provides security measures against various situations and methods to realize cost reductions.
4	[Search by Illustration]	Searches for the required operations of this machine based on the output result, functions, and operation images.

Operating environment

Item	Specifications
Supported operating systems	Windows 7 (SP1), Windows 8.1, Windows 10 Mac OS 10.8/10.9/10.10/10.11/10.12
Supported Web browsers	Windows: Microsoft Internet Explorer 9.x/10.x (Desktop version)/11.x (Desktop version), Microsoft Edge, Firefox 20 or later, Google Chrome 26 or later Mac OS: Safari 6.0.3 to 10.x <ul style="list-style-type: none"> We recommend that you use the latest Web browser that is compatible with your operating system to help you use this machine more conveniently and comfortably. Check that JavaScript in your Web browser is enabled. The User's Guide uses JavaScript for the page display and search functions.
Display resolution	1024 × 768 pixels or more

2.2.2 Target groups

The user's guides (see page 2-4) are intended for the following users of the system:

Target group	Description
User	Persons using the system for its intended use (see page 2-3) as well as managing system functions and consumables according to the assigned user rights.
Administrator	Persons managing consumables, system functions, users and access rights; adjusting system settings, and establishing network connections.

Everyone who uses this system must have read and understood the related user's guides.

2.2.3 Symbols and notations used in this manual

Procedural instruction

- ✓ This check mark symbol shows a precondition of a procedure.
- 1 This format number "1" represents the first step.
- 2 This format number represents the order of serial steps.
 - This symbol indicates a supplementary explanation of a procedural instruction.

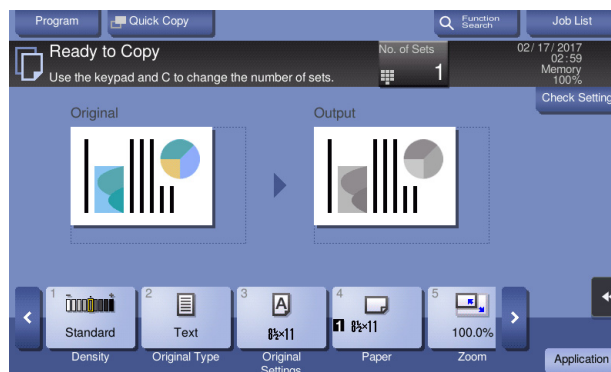

Symbols and notations

WARNING

- Improper handling can cause serious injury or death.

CAUTION

- Improper handling can cause minor injury or damage to houses and property.

NOTICE

This symbol indicates a risk that may result in damage to this machine or documents. Follow the instructions to avoid property damage.



Tips

- This symbol indicates supplemental information of a topic as well as options required to use a function.



Reference

This symbol indicates reference functions related to a topic.



Related setting

This shows the settings related to a particular topic for any user.



Related setting (for the administrator)

This shows the settings related to a topic only for administrators.

Symbols/Notations	Description
✓	This check mark symbol shows a precondition of a procedure.
→	This symbol indicates a supplementary explanation of a procedural instruction.
[]	An item enclosed by brackets [] indicates a key name on the Touch Panel or computer screen, or the name of a user's guide.
Bold text	This presents a key name, part name, product name, or option name on the Control Panel .

Names and notations of applications

This manual uses a notation for each application name as shown below.

Name	Notations used in this manual
PageScope Web Connection	Web Connection

A large, bold, black number '3' is centered within a gray square. The square is positioned to the left of the text 'Overview of This Machine'.

Overview of This Machine

3 Overview of This Machine

3.1 About this machine

3.1.1 Name of parts

Front

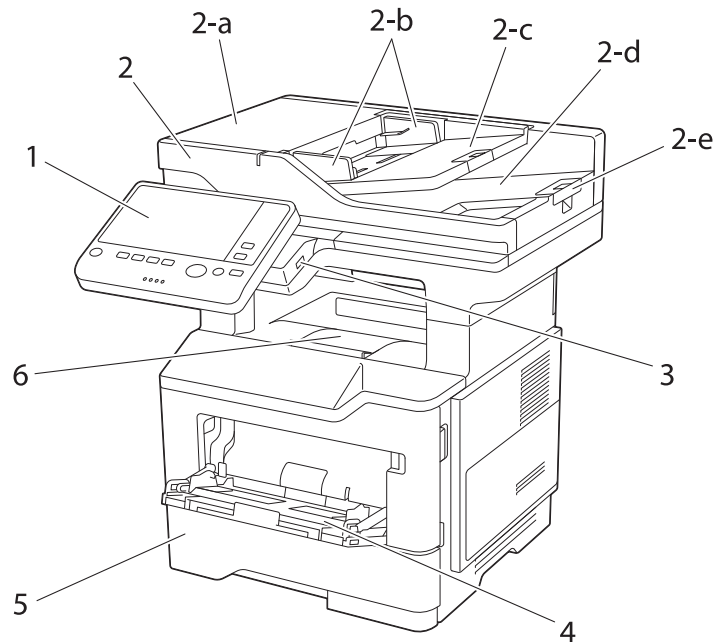

No.	Name	Description
1	Control Panel	Used to configure various settings in this machine.
2	Automatic Document Feeder (ADF)	Automatically feeds and scans originals by page. This unit also reverses and automatically scans 2-sided originals. This unit is referred to as ADF in the manual.
2-a	ADF Feed Cover	Open this cover when clearing a paper jam in the ADF .
2-b	Lateral Guide	Adjust this guide along the width of the original.
2-c	Original Tray	Load the original face up in this tray.
2-d	Original Output Tray	The scanned original is fed out onto this tray.
2-e	Document Stopper	Used to prevent the output original from falling.
3	USB Port (Type A) USB2.0/1.1	Used to connect an external memory unit (USB memory unit) to this machine.
4	Bypass Tray	Used to print data on non-standard size paper or envelopes. For details on the available types of paper, refer to [Introduction] in the User's Guide CD/DVD.
5	Tray1	Allows you to load up to 550 sheets. For details on the available types of paper, refer to [Introduction] in the User's Guide CD/DVD.
6	Output Tray	Outputs printed pages.

Side/rear

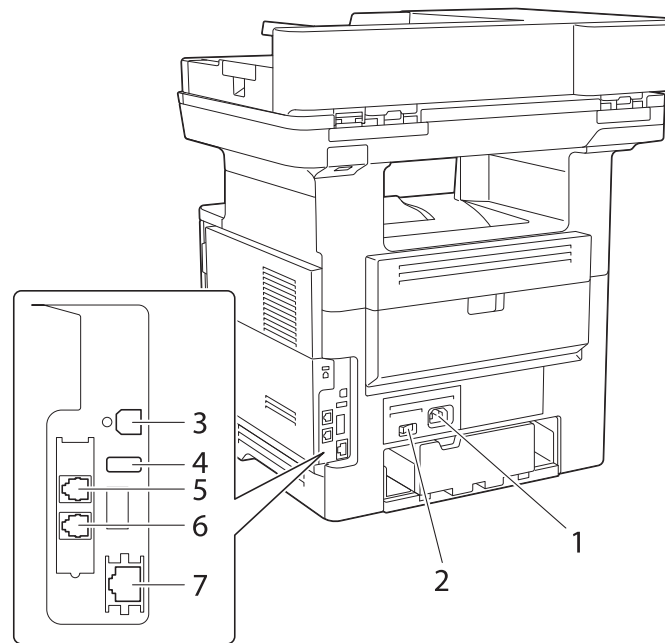

No.	Name	Description
1	Power Connection	Connect the power cord to this inlet to supply power to this machine.
2	Power Switch	Press this switch to turn the machine on or off.
3	USB Port (Type B)	Connect to this port when using this machine as a USB-connected printer.
4	USB Port (Type A)	Connect to this port when using the Authentication Unit .
5	Jack for connecting a telephone (TEL)	Used to connect a telephone cord.
6	LINE (telephone line) Jack	Used to connect a general telephone subscriber line.
7	Ethernet (LAN) Port (1000Base-T/100Base-TX/10Base-T)	Connect to this port when using this machine as a network printer or network scanner.

Tips

- The network port of this product is following No.3 and No.7. A port is activated when a network port inserts a cable.

3.1.2 Option configuration

List of optional components

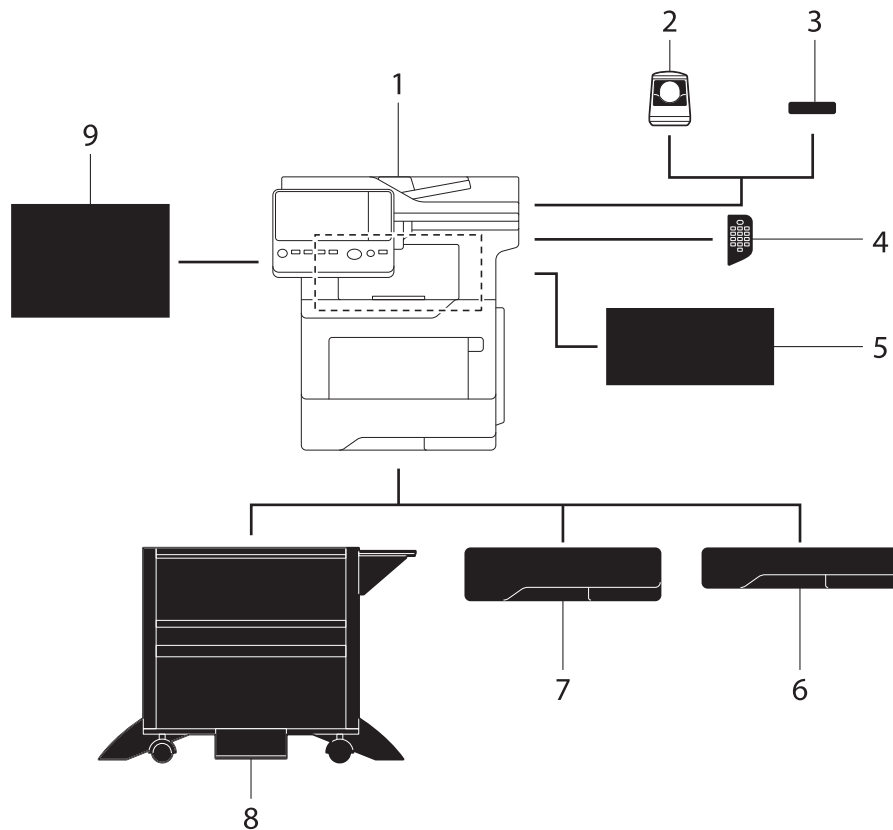

No.	Name	Description
1	Main unit	Scans the original in the scanner section, and prints a scanned image in the printer section. This unit is referred to as "machine", "main unit", or "4752/4052" in the manual.
2	Authentication Unit AU-102	Performs user authentication by scanning vein patterns in the finger. This unit is referred to as an Authentication Unit in the manual.
3	Authentication Unit AU-201S	Performs user authentication by scanning information recorded on the IC card or NFC-compatible Android terminal. This unit is referred to as an Authentication Unit in the manual.
4	Keypad KP-101	It is equipped on the side of the Control Panel . Allows you to enter numbers by using the Hardware Keypad.
5	Finisher FS-P02	Staples the printed sheets. For staples, use Staple Kit SK-501 .
6	Paper Feed Unit PF-P15	Allows you to load up to 250 sheets. Up to three levels can be attached.
7	Paper Feed Unit PF-P16	Allows you to load up to 550 sheets. Up to three levels can be attached.
8	Desk DK-P02	Used to install this machine on the floor. This unit is referred to as Desk in the manual.
9	Clean Unit CU-203	Collects small particles (UFP) generated in this machine to prevent them from escaping this machine. Clean Unit CU-203 may not be available in some areas.

List of other optional components

The following options are built into this machine and are not shown in the figure.

No.	Name	Description
1	Fax Kit FK-517	Used to operate this machine as a fax machine.
2	Local Interface Kit EK-P06	Install this unit when using the connection function with a Bluetooth LE-compatible iOS terminal. The USB port and receiving device for Bluetooth LE communication are added.
3	Local Interface Kit EK-P07	Used to add an RS-232C port.
4	i-Option LK-102 v3	Supports the PDF processing function that is one of the advanced functions.
5	i-Option LK-106	Used to add a bar code font that is one of special fonts.
6	i-Option LK-107	Used to add a unicode font that is one of special fonts.
7	i-Option LK-108	Used to add an OCR font that is one of special fonts. In the standard, the OCR-B font (PostScript) is available. Installing the i-Option LK-108 allows use of the OCR-A font (PCL).
8	i-Option LK-111	Supports the ThinPrint function that is one of the advanced functions.
9	i-Option LK-114	Supports the serverless pull printing function that is one of the advanced functions.
10	i-Option LK-115 v2	You can use TPM (Trusted Platform Module) that is one of the advanced functions. Security enhancement is realized by encrypting confidential information such as certificates and passwords of this machine.
11	Upgrade Kit UK-219	<ul style="list-style-type: none"> Install this unit when using i-Option LK-102 v3, LK-106, LK-107, LK-108, or LK-114. Install this unit when using My Address in association with My Panel Manager. This unit is referred to as Extension Memory in the manual.
12	Upgrade Kit UK-216	Allows you to use this machine in a wireless network environment. The models for North America provide Upgrade Kit UK-216 as standard.

3.2 Power Supply

3.2.1 Power Switch and Power key locations

This machine has two power switches: **Power Switch** outside the machine and **Power key** on the **Control Panel**.

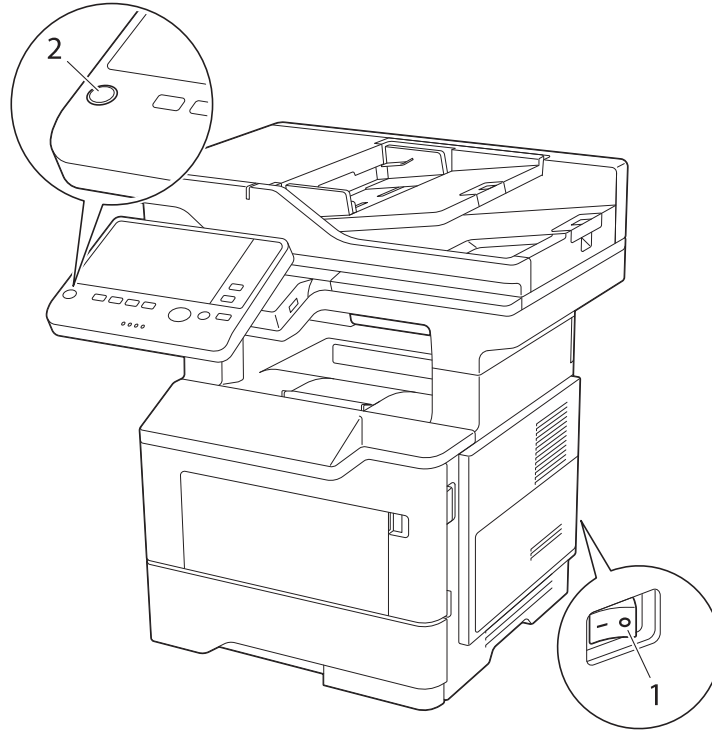

No.	Name	Description
1	Power Switch	Press this switch when turning on or off the main power of this machine or restarting this machine.
2	Power key	Press this key to switch this machine to the Power Save mode. This function reduces power consumption and has a greater power saving effect. For details, refer to page 3-8.

NOTICE

*While printing, do not turn the **Power Switch** off or press the **Power key**. Otherwise, it may lead to a paper jam.*

*If the **Power Switch** is turned off or the **Power key** is pressed while this machine is running, the system deletes the currently loaded data or communicating data as well as queued jobs.*

3.2.2 Turning the Power Switch ON or OFF

- 1 When turning the main power on, press | of the **Power Switch**.

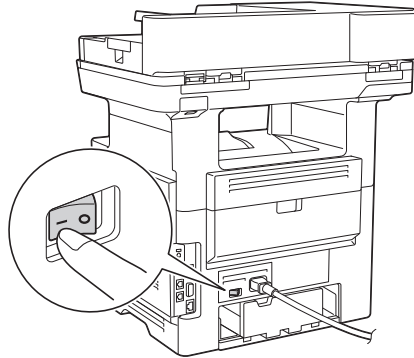

The **Start** key lights up orange, and a screen appears to show that this machine is in the process of start-up.

When the **Start** key changes to blue, this machine is ready to use.

- 2 When turning the main power off, press ○ of the **Power Switch**.

NOTICE

When restarting this machine, turn the **Power Switch** off and on again after 10 or more seconds have elapsed. Not doing so may result in an operation failure.

3.2.3 Using the Power key

- ➔ Press the **Power** key to switch this machine to the Power Save mode.

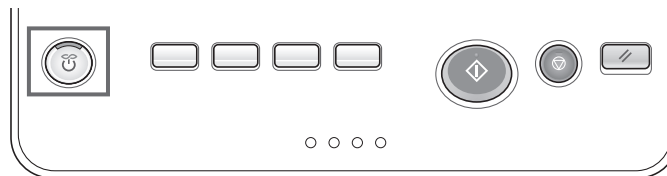

- ➔ You can select [Power Save] or [Sub Power OFF] as Power Save mode that is activated when the **Power** key is pressed.
- ➔ To configure settings: [Utility] - [Administrator Settings] - [System Settings] - [Power Supply/Power Save Settings] - [Power Save Key] (default: [Power Save])

When using the Power key as a Power Save key

When the **Power** key is pressed, the status of this machine changes as shown below. Depending on how long the **Power** key is pressed, the state of the power save mode to be activated will differ.

Power key	Status of this machine	Status of LED	Description
Short press	Low Power mode (Default)	Flash: Blue	Turns off the display of the Touch Panel to reduce power consumption. This machine returns to the normal mode when it receives data or faxes or when the user operates the Touch Panel .
	Sleep mode	Flash: Blue	Provides power-saving effect higher than Low Power mode. A time required to return to the normal mode is longer than Low Power mode. This machine returns to the normal mode when it receives data or faxes or when the user operates the Touch Panel .
Hold down	Sub Power OFF	Light up: Orange	The power saving effect is the same as that of the sleep mode. While the sub power is turned off, this machine can receive data or faxes, however, it cannot scan or print an original. If data or faxes are received while the sub power is turned off, they are printed when the machine returns to the normal mode. To enable the machine to return to the normal mode from the Sub Power Off status, press the Power key again.



Related setting (for the administrator)

- Press the **Power** key to select whether to switch to Low Power or Sleep mode.
To configure settings: [Utility] - [Administrator Settings] - [System Settings] - [Power Supply/Power Save Settings] - [Power Save Settings] (Default: [Low Power])

When using the Power key as a Sub Power Off key

When the **Power** key is pressed, the status of this machine changes as shown below. Depending on how long the **Power** key is pressed, the state of the power save mode to be activated will differ.

Power key	Status of this machine	Status of LED	Description
Short press	Sub Power OFF	Light up: Orange	This function reduces power consumption and has a greater power saving effect. While the sub power is turned off, this machine can receive data or faxes, however, it cannot scan or print an original. If data or faxes are received while the sub power is turned off, they are printed when the machine returns to the normal mode. To enable the machine to return to the normal mode from the Sub Power Off status, press the Power key again.
Hold down	ErP Auto Power OFF	Flash: Orange	This function provides a greater power saving effect than the sub power off mode, which is close to the state where the main power is turned off. In ErP Auto Power Off mode, this machine cannot receive data or faxes, and also it cannot scan or print an original. To enable the machine to return to the normal mode from the ErP Auto Power OFF status, press the Power key again.

3.3 Control Panel

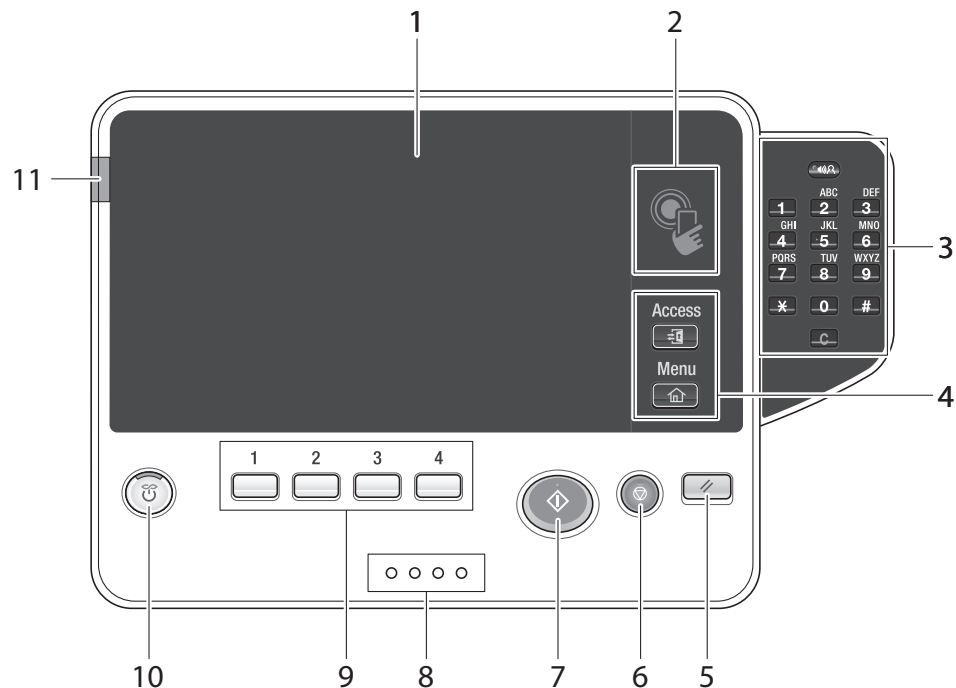

Tips

- This figure shows an optional **Keypad KP-101** installed.

No.	Name	Description
1	Touch Panel	Displays setting screens and messages. Directly press this panel to carry out operations.
2	Mobile touch area	Used to associate this machine with an NFC-compatible Android terminal. You can place an Android terminal with PageScope Mobile for Android installed on the mobile touch area to register this machine or to perform user authentication. This area is also used to associate this machine with an iOS terminal that supports Bluetooth LE. The optional Local Interface Kit EK-P06 is required to use the Bluetooth LE function. Bringing the iOS terminal closer to this machine allows you to register this machine or perform user authentication with an operation from PageScope Mobile for iPhone/iPad . For details on the association with an Android/iOS terminal, refer to [Web Management Tool] in the User's Guide CD/DVD.
3	Keypad KP-101	Keypad: Use this keypad to enter numeric values such as the number of copies or zoom ratio. This keypad is also used to select a numbered setting key. C (Clear): All the numeric values(number of pages, magnification, size, etc), which have been entered by keypad, are canceled.
4	Access	Press this key to perform authentication in the Login screen if user authentication or account track is installed on this machine. Pressing the Access key while logged in will log you out of this machine.
	Menu	Press this key to display the Main Menu. The Main Menu displays shortcut keys assigned to selected functions, enabling you to quickly access a desired function. For details on the main menu, refer to page 3-17.
5	Reset	Press this key to reset the settings you entered or changed on the Control Panel .

No.	Name	Description
6	Stop	Press this key to temporarily stop an active copy, scan, or print job. <ul style="list-style-type: none"> • To restart, press the Start key. • To delete, select a target job in the currently stopped screen, then tap [Delete].
7	Start	Press this key to start an operation such as copying, scanning, faxing, or printing. <ul style="list-style-type: none"> • Lights up blue: This machine is ready to start operating. • Lights up orange: This machine is not ready to start operating. If this indicator lamp lights up orange, check whether any warning or message is displayed on the Touch Panel.
8	Data Indicator	Flashes or lights up to indicate the data receiving status on this machine. <ul style="list-style-type: none"> • Flash in blue: Receiving a data. • Lights up blue: Accumulating data.
9	1 - 4	Press each key to switch the display of the Touch Panel to a function assigned to a Register key. <ul style="list-style-type: none"> • By default, Register key 1 is assigned to [Enlarge Display], 2 to [Guidance], 3 to [10 Keypad], and 4 to [Preview]. • A function to be assigned to a Register key can be changed to suit your environment. For details, refer to [Control Panel] in the User's Guide CD/DVD.
10	Power key	Press this key to switch this machine to the Power Save mode. For details on how to use the Power key, refer to page 3-8.
11	Warning Indicator	Indicates the status of this machine by the lamp color, flashing, or a lamp lighting up. <ul style="list-style-type: none"> • Flash in orange: Warning • Lights up orange: The machine has stopped.

3.4 Operating the Touch Panel

Tap

Lightly touch the screen with your finger, then remove your finger from the screen immediately.

This action is available when selecting or determining a menu.



Double-tap

Lightly touch the screen with your finger twice in succession.

Used to retrieve detailed information, to enlarge a thumbnail or preview image, and to open a User Box.

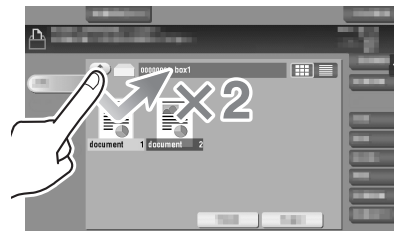

Flick

Make a slight fillip while sliding your finger on the screen.

Used to scroll the destination/job list or to feed a page in the Main menu screen/Preview screen.

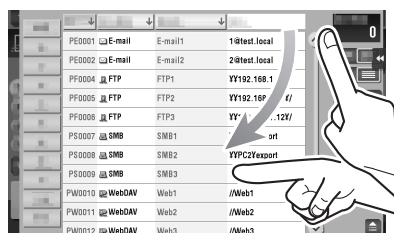

Drag

To move the scroll bar or document, place your finger on it and move your finger.

Used to move the scroll bar or document.

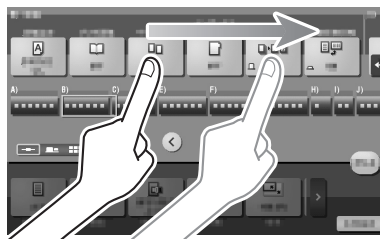

Pan

Slide your finger parallel in a front-to-back and side-to-side direction on the screen.

Used to move to the intended display location if data spans multiple screens.

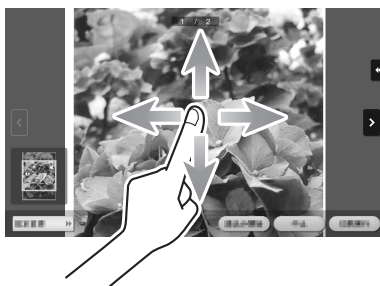

Long-tap

Hold down the document by the finger.

Used to display the icon related to the document.

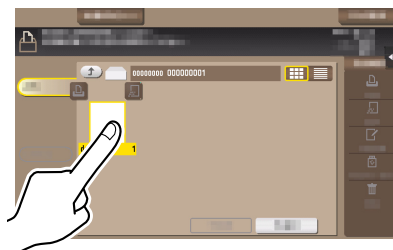

Drag & Drop

Slide your finger to the intended place and release it while a document is selected.

Used to move the document to the intended place.

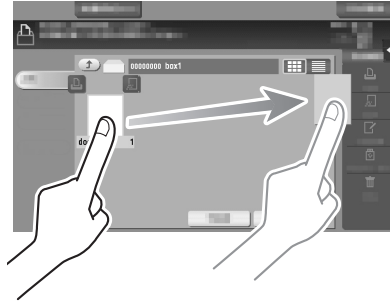

Pinch-in / Pinch-out

Place two fingers on the screen and then open or close them.

Used to enlarge or reduce a preview image.



Related setting

- When Zoom Display Setting is enabled, you can enlarge the entire panel display up to 200% using the pinch-out operation.
To configure settings: [Utility] - [User Settings] - [Custom Display Settings] - [Accessibility Settings] ([No] is specified by default.)

Rotation

Place two fingers on the screen and then rotate them.

Used to rotate a preview image.

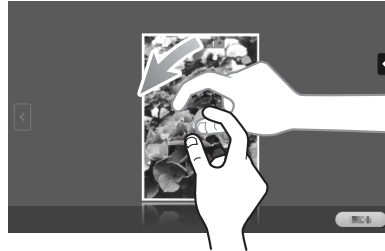

Displaying the Keypad

Tap a number or input area on the screen to display the **Keypad**.

Used to enter numerals.



Moving the Keypad

Touch the top of the **Keypad** with your finger and move it as desired.

Used to move the position to display the **Keypad**.

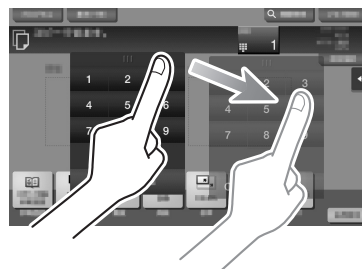

Switching to the entry or selection screen

Tap a target input area or icon to switch to the entry or selection screen.

Used to switch into the Select screen to enter text or select a registered item.



Precautions on using the Touch Panel

This machine features a capacitance-base touch panel. Note the following points when operating the **Touch Panel**.

- Use your finger or a **Stylus Pen** available commercially. Note that the **Touch Panel** will not respond appropriately if you operate it using your nail or a pen tip instead of your finger or the **Stylus Pen**.
- Applying a strong force to the **Touch Panel** will damages the **Touch Panel**, and potentially cause a breakage.
- When operating the **Touch Panel**, do not press on it using excessive force or with a pointed object such as a mechanical pencil.
- Be careful not to operate **Touch Panel** with wet fingers. It may cause **Touch Panel** to be improperly operated.
- If you operate the **Touch Panel** with a gloved finger, the **Touch Panel** will not respond normally. You should operate it with a bare finger or using the **Stylus Pen**.
- Note that the **Touch Panel** may not respond normally if the distance between the user and fluorescent light is 19-11/16 inches (500 mm) or less when you operate the **Touch Panel**.
- You must not use the Touch Panel near equipment that generates electrical noises such as an electric generator or air conditioner. Otherwise a malfunction may be caused by an influence of electrical noises.

3.5 Main Menu

Press the **Menu** key on the **Control Panel** to display the main menu. You can customize the keys to be displayed on the main menu freely to suit your requirements.

The main menu can be extended to three screens as necessary. It can show 12 shortcut keys in each screen, and up to 25 shortcut keys in three screens. [Utility] is displayed fixed on the lower right of the first page.

If shortcut keys of frequently-used functions are arranged on the main menu, it helps you quickly access a target function.

Furthermore, the background of the main menu can be changed according to your preference.

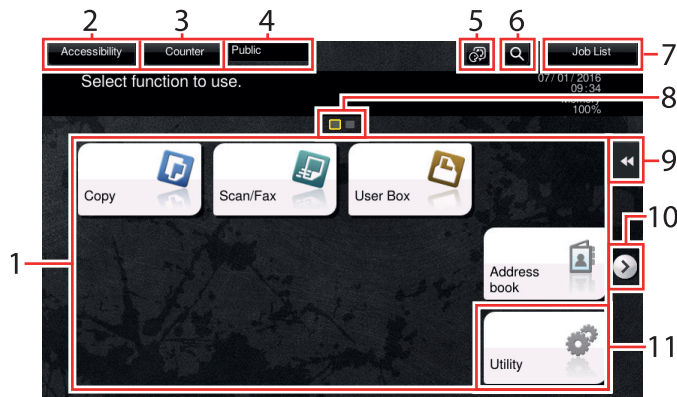

No.	Name	Description
1	Main menu keys	Display shortcut keys assigned to any function. Shortcut keys can be customized freely to suit your requirements. By default, [Copy], [Scan/Fax], [User Box], [Address book], and [Utility] are arranged on the main menu. ([Utility] is fixed.) <ul style="list-style-type: none"> In some areas, [Quick Security] is located on the main menu by default. For details on [Quick Security], refer to [Descriptions of Functions/Utility Keys] in the User's Guide CD/DVD.
2	[Accessibility]	Tap this button to configure the operating environment of the Control Panel , for example, by adjusting the Touch Panel or changing keying sounds. For details, refer to [Accessibility] in the User's Guide CD/DVD.
3	[Counter]	The total number of pages printed by this machine will be displayed while being summarized by each function.
4	User/Account Name	This area displays the name of the current login user or the account track name when User Authentication or Account Track is enabled. When User Authentication and Account Track are used together, the user name is displayed.
5	[Language]	Tap this button to temporarily change the language to be displayed on the panel. <ul style="list-style-type: none"> This option is displayed when [Temporary Change Language Setting] is set to [ON]. To configure settings: [Utility] - [Administrator Settings] - [System Settings] - [Custom Display Settings] - [Temporary Change Language Setting]
6	[Function Search]	Tap this button to search for copy settings or fax/scan settings to go to the target function screen from the search result.
7	[Job List]	Tap this button to display current or standby jobs. If necessary, you can check job logs or print a communication report. This list displays the operation status of the current job when it is running.
8	Page Indicator	Allows you to check which page is currently displayed when main menu keys are assigned to multiple pages.
9	Slide Menu	This menu is a menu that slides out from the edge of the screen and is displayed when the user taps the menu display tab key.

No.	Name	Description
10	Page switching key	Tap this key to switch pages when main menu keys are assigned to multiple pages. Pages can also be switched by dragging or flicking the screen.
11	[Utility]	Tap this button to configure settings of this machine or check the use status of this machine.

3.6 Entering characters

When entering characters to register an address or program, use the keyboard screen displayed on the Touch Panel.

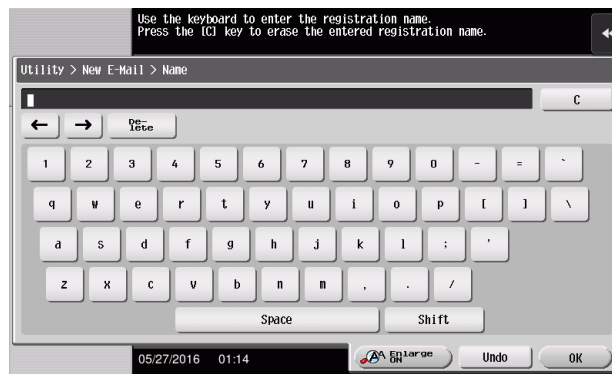

Item	Description
Keyboard	Tap the keys of characters you want to enter.
[C]	Tap this key to delete a character or value you entered.
[←]/[→]	Tap this key to move the cursor.
[Delete]	Tap this key to delete characters you entered one by one.
[Shift]	Tap this key to enter uppercase letters or symbols.
[Enlarge ON]	Tap this key to enlarge the keyboard. <ul style="list-style-type: none"> To release the enlargement, tap [Enlarge OFF].
[Cancel]	Text entry is interrupted and the page returns to the previous screen. The character or value you entered is deleted.
[Undo]	Tap this key to delete a character or value you entered.
[OK]	Define the entered character or numeric values.



Loading Paper

4 Loading Paper

4.1 Paper

4.1.1 Confirm the available paper types

Paper type	Paper weight	Paper capacity
Plain paper Recycled paper Single Side Only ^{*2} Special Paper ^{*3} Colored Paper ^{*5} User Paper 1 ^{*6} User Paper 2 ^{*6}	15-15/16 lb to 23-15/16 lb (60 g/m ² to 90 g/m ²)	Bypass Tray: 100 sheets ^{*1} Tray1: 550 sheets ^{*1}
Letterhead ^{*4}	15-15/16 lb to 23-15/16 lb (60 g/m ² to 90 g/m ²)	Bypass Tray: 100 sheets Tray1: 550 sheets
Thick 1 User Paper 3 ^{*6}	24-3/16 lb to 31-15/16 lb (91 g/m ² to 120 g/m ²)	Bypass Tray: 20 sheets Tray1: 550 sheets
Thick 1+ User Paper 4 ^{*6}	32-3/16 lb to 41-3/4 lb (121 g/m ² to 157 g/m ²)	Bypass Tray: 20 sheets
Thick 2 User Paper 5 ^{*6}	42 lb to 57-7/16 lb (158 g/m ² to 216 g/m ²)	Bypass Tray: 20 sheets
Postcards	-	Bypass Tray: 20 sheets
Envelopes	-	Bypass Tray: 10 sheets
Label sheets	-	Bypass Tray: 30 sheets Tray1: 550 sheets

^{*1} Available for 20 lb (75 g/m²).

^{*2} Paper on which you will not print on both sides (for example, when something is already printed on the front side).

^{*3} Fine and other special paper.

^{*4} Paper where company names, preset text, and others are already printed.

^{*5} Colored paper.

^{*6} Paper that is registered as one of frequently used paper types.

NOTICE

Paper other than plain paper is referred to as special paper. When loading special paper into the paper tray, specify the correct paper type. Otherwise, it may result in a paper jam or image error.



Tips

- For paper weight and media adjustment settings, contact your service representative.
- When printing on the reverse side of a sheet printed on one side, load paper into the **Bypass Tray**, and select [Duplex 2nd Side] in the paper setting, improving a reduction of the printing image quality. [Duplex 2nd Side] is available when plain paper, Thick 1, Thick 1+, or Thick 2 is selected to be printed from the **Bypass Tray**.

4.1.2 Confirm the available paper sizes

Paper feed port	Allowable sizes
Bypass Tray	8-1/2 × 14, 8-1/2 × 12-11/16, 8-1/2 × 11, 8 × 10-1/2, 8 × 10, 7-1/4 × 10-1/2, 5-1/2 × 8-1/2 A4, B5, A5, B6, A6 4 × 6, A6 card, double postcard, envelope (B5, C6, DL, Com10, Monarch, Japanese Western-style 3, long form 3, long form 4) 8 × 13*, 16K Width: 3 inches to 8-1/2 inches (76.2 mm to 215.9 mm), Length: 5 inches to 14 inches (127 mm to 355.6 mm)
Tray1	8-1/2 × 14, 8-1/2 × 12-11/16, 8-1/2 × 11, 8 × 10-1/2, 7-1/4 × 10-1/2, 5-1/2 × 8-1/2 A4, B5, A5, B6, A6 8 × 13

* There are five types of foolscap: 8-1/2 × 13-1/2, 8-1/2 × 13, 8-1/4 × 13, 8-1/8 × 13-1/4, and 8 × 13. Any one of these sizes is selectable. For details, contact your service representative.

Tips

- All paper sizes have a printable area, excluding 3/16 ± 1/16 inches (4.2 ± 2.0 mm) from the edges of the paper for printing, and 3/16 ± 1/16 inches (4.0 ± 2.0 mm) from the edges of the paper for copying. When configuring a user setting of the page size using the application, specify the paper size within the printable area so that the optimal result is obtained.
- On an envelope, it is only possible to print on the front (address) side. Also, the result of printing on the seal overlapping part on the front side cannot be assured. The area that cannot be assured varies depending on envelope types.
- The page margin setting is determined depending on your application. If the default paper size or margin is selected, there may be some part of the paper that is not able to be printed on. To obtain the optimal result, configure the custom setting so that an image is included in the printable area of this machine.

4.1.3 Precautions for Correct Operations

Unavailable paper

Do not load the following paper into the tray. Not observing these precautions may lead to reduced print quality, a paper jam or damage to the machine.

- Paper that has been printed on with a heat-transfer printer or an inkjet printer
- Folded, curled, wrinkled, or torn paper
- Paper that has been left unwrapped for a long period of time
- Damp paper, perforated paper, or paper with punched holes
- Extremely smooth or extremely rough paper, or paper with an uneven surface
- Treated paper such as carbon-backed paper, thermal paper, pressure-sensitive paper, or iron-on transfer paper
- Paper that has been decorated with foil or embossing
- Paper of a non-standard shape (paper that is not rectangular)
- Paper that is bound with glue, staples or paper clips
- Paper with labels attached
- Paper with ribbons, hooks, buttons, etc., attached
- Envelopes that have glue or release paper on the flaps or the flap-covered part of the body
- Paper with different paper quality (roughness) on the front and back sides
- Paper that is too thin or too thick
- Paper containing static electricity
- Acidic paper
- Other types of unavailable paper

Storing paper

Store paper in a cool, dark location with little humidity. If paper contains moisture, a paper jam may occur.

Store the paper flat, not on its edge. Curled paper may cause a paper jam.

4.2 Loading Paper in Bypass Tray

How to load paper into the Bypass Tray

When selecting a paper size other than for paper trays, use the **Bypass Tray**.

NOTICE

To use the **Bypass Tray**, load paper and specify the paper size and paper type.

Do not load the following paper into the **Bypass Tray**. Doing so may cause a paper jam or damage to the machine.

- Folded, torn or creased paper, or bundles of sheets of different sizes

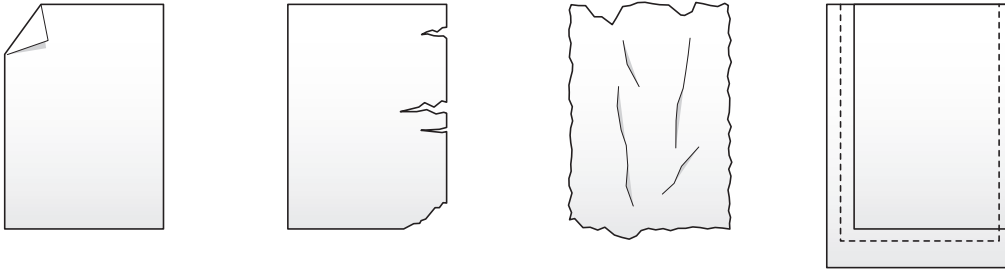

- 1 Open the **Bypass Tray**.

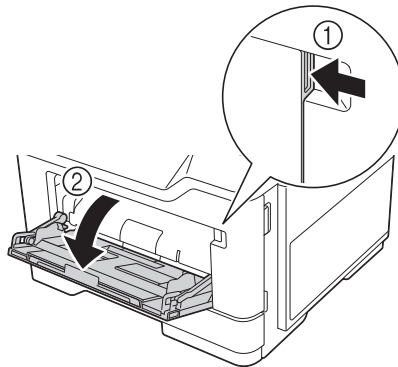

- 2 Pull out the extension guide of the **Bypass Tray**.

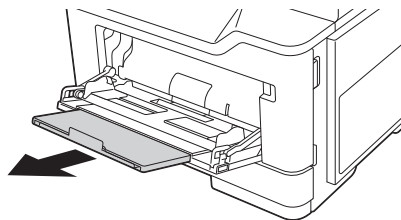

- 3 Slide the **Lateral Guide** to fit the size of the loaded paper.

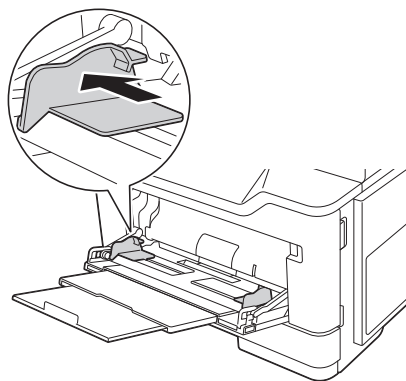

- 4 Load paper into the tray with the print side facing up.
→ Insert paper into the tray until their edges are pressed against the back.

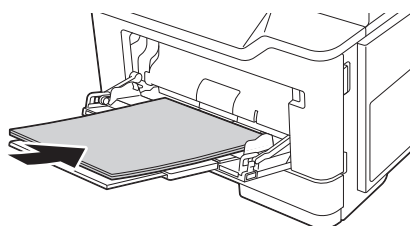

- For details on the available paper sizes, refer to page 4-4.
→ For details on how to load postcards, envelopes, and letterhead paper, refer to [Introduction] in the User's Guide CD/DVD.

NOTICE

Do not load an excessive number of sheets such that the top of the stack is higher than the upper-limit indicator guide.

If paper is curled, flatten it before loading it.

- 5 Slide the **Lateral Guide** to fit the size of the loaded paper.
6 Change the paper type and paper size on the **Control Panel**.
→ To configure settings: [Copy] - [Paper]

4.3 Loading paper into Tray 1

- ✓ **Tray2, Tray3, and Tray4** are available when the optional **Paper Feed Unit** is installed on this machine. The procedure for loading paper is common between **Tray1** to **Tray4**.

NOTICE

To prevent the machine from becoming unstable, feed paper individually into each tray. While paper is loaded into one tray, all the other trays must be closed.

- 1 Pull out **Tray1**.

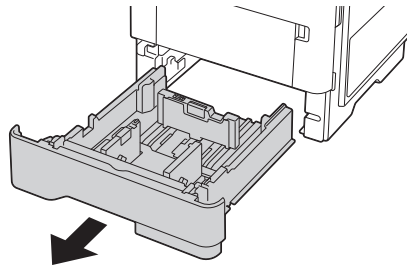

- 2 Pinch the paper guide tab, then slide the **Lateral Guide** to fit the size of the paper to be loaded.
→ After moving the vertical **Lateral Guide**, slide the lock tab (3) to lock the **Lateral Guide**. Whether or not the guide plate is locked can be ascertained via the lock/unlock mark.

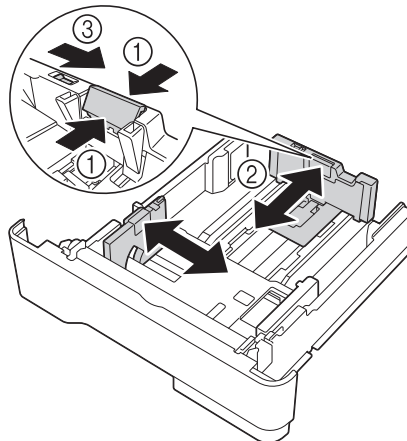

- 3 Load paper into the tray with the print side facing down.
 - When loading long paper such as A4, letter-size, or legal-size paper, pinch the vertical paper guide tab, and slide the paper guide backward to suit the paper length.
 - If legal-size paper is loaded, the vertical paper guide tab protrudes from the tray base, and paper may become dusty as a result. To prevent paper from becoming dusty, purchase and mount a dust cover. For details, contact your service representative.
 - When loading A6-size paper, pinch the vertical paper guide tab, and slide the paper guide to the A6-size position in the center of the tray.
 - Check that the horizontal **Lateral Guide** and vertical **Lateral Guide** match the paper sizes shown on the bottom of the tray.
 - Do not move paper in the tray.

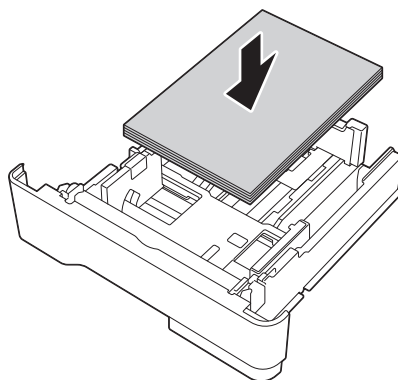

- For details on the available paper sizes, refer to page 4-4.
- For details on how to load letterhead paper, refer to [Introduction] in the User's Guide CD/DVD.

NOTICE

Do not load an excessive number of sheets such that the top of the stack is higher than the upper limit indicator mark.

If paper is curled, flatten it before loading it.

- 4 Slide the **Lateral Guide** to fit the size of the loaded paper.
- 5 Close **Tray1**.
- 6 Change the paper type and paper size on the **Control Panel**.
 - To configure settings: [Copy] - [Paper]

5

Initial Settings of This Machine

5 Initial Settings of This Machine

5.1 Preparation for network connection (for administrators)

Checking a LAN cable for connection

Check that a LAN cable connected to the network is connected to the LAN port of this machine.

For details on the cable connection port, refer to page 3-4.

Assigning an IP address

If this machine has a fixed IP address, manually enter the IP address, subnet mask, and default gateway address.

In the **Control Panel**, select [Utility] - [Administrator Settings] - [Network Settings] - [TCP/IP Setting] - [IPv4 Settings], then configure the following settings.

Settings	Description
[IP Application Method]	To manually enter the IP address, select [Manual Input]. To automatically obtain the IP address using DHCP, select [Auto Input], then specify the auto input method. [Auto Input] is specified by default.
[IP Address]	Enter the fixed IP address assigned to the machine.
[Subnet Mask]	Enter the subnet mask.
[Default Gateway]	Enter the default gateway.

Tips

- To check the IP address assigned to this machine, select [Utility]-[Device Information].

5.2 Preparation for fax (for administrators)



Tips

- To use the fax functions, the optional **Fax Kit** is required.

Checking the modular cable connection

Check that a modular cable is connected between the LINE port and the appropriate telephone line.

For details on the cable connection port, refer to page 3-4.

Specifying the type of telephone line

Specify the type (dialing method) of telephone line to which this machine is to be connected. The dialing method must be correctly specified to ensure communications.

To configure settings: [Utility] - [Administrator Settings] - [Fax Settings] - [Line Parameter Setting] - [Dialing Method]

Making preparations for using the machine in a Private Branch Exchange (PBX) environment

When you use this machine in a PBX environment, register an outside line number.

To configure settings: [Utility] - [Administrator Settings] - [Fax Settings] - [PBX Connection Setting]

Selecting a receiving method

Methods of receiving faxes include the following: This machine receives faxes automatically, and the user receives faxes manually. Set the receiving method to your environment.

To configure settings: [Utility] - [Administrator Settings] - [Fax Settings] - [Line Parameter Setting] - [Receive Mode]

Registering the sender information

Register the name of this machine and the company name (sender name) as well as the fax number of the machine.

The information you registered is added to faxes to be sent and output to faxes as a sender record when being printed on receiving machines.

To configure settings: [Utility] - [Administrator Settings] - [Fax Settings] - [Header Information]

Set the date and time for the machine

Set the date and time in this machine to have them printed on sent and received faxes. The date and time you set will be the reference time for the Timer TX that enables communication at a preset time.

To configure settings: [Utility] - [Administrator Settings] - [System Settings] - [Date/Time Settings]

5.3 Security settings (for administrators)

5.3.1 Hard Disk setting

To encrypt the data saved on the hard disk of this machine to protect it, specify the hard disk encryption setting.

Because the hard disk will be formatted when the hard disk encryption setting is specified, the data saved on the hard disk will be deleted. Therefore, we recommend that you finish an HDD encryption setting before using this machine.

To configure settings: [Utility] - [Administrator Settings] - [Security Settings] - [Storage Management Settings] - [HDD Encryption Setting]



Related setting (for the administrator)

- When enabling the enhanced security mode to use this machine, you need to configure an HDD encryption setting. For details on the enhanced security mode, refer to [Descriptions of Functions/Utility Keys] in the User's Guide CD/DVD.

5.3.2 Configuring [Quick Security Setting]

[Quick Security Setting] provides a collection of settings to enhance security performance of this machine.

In order to use this machine securely, we recommend that you change the administrator password to one that complies with the password rules and specify the settings for [Quick Security Setting] in advance. By default, the security warning screen is displayed if the administrator password remains set to the default or the password rules are not satisfied.

Tap [Quick Security] on the main menu to display the [Quick Security Setting] screen. For details on the settings, refer to [Descriptions of Functions/Utility Keys] in the User's Guide CD/DVD.



Related setting (for the administrator)

- In some areas, [Quick Security] is located on the main menu by default. However, if [Administrator Password] in [Quick Security Setting] screen was changed from the default setting and [Password Rules] is set to [Enable], the [Quick Security] will not be displayed on the main menu. To display the key again, specify the setting in the following location.

To configure settings: [Utility] - [Administrator Settings] - [System Settings] - [Custom Display Settings] - [Main Menu Default Settings]

5.4 Administrator Password

The administrator password is set to [1234567812345678] by factory default.

Change the administrator password periodically.

If the administrator password is lost, contact your service representative.

A large, bold, black number '6' is centered within a gray square. The square is positioned to the left of the text 'Basic Usage'.

Basic Usage

6 Basic Usage

6.1 Using the print function (Windows environment)

This section describes how to configure print settings in Windows environment.



Reference

For details on how to configure print settings in Mac OS environment, refer to [Print] in the User's Guide CD/DVD.

6.1.1 Printer driver

Before using this machine as a printer, you need to install the printer driver on your computer.

The following types of printer drivers are available. Select the printer driver that meets your printing aims.

Printer driver	Page description language	Description
PCL driver	PCL6	This is a standard driver for printing general office documents. Among the three drivers, this driver provides the fastest printing speed.
PS driver	PostScript 3 Emulation	This driver is effective for high-definition printing of data created in PostScript-supporting application software from Adobe or other vendors. This driver is often used in graphics and light printing applications where good color reproducibility is important.
XPS driver	XPS	Driver compatible with XML Paper Specification (XPS). This driver has several advantages, including high-quality reproduction of translucence.

6.1.2 Preparation for printing (network connection)

Checking the LAN cable connection

Check that a LAN cable is connected to the LAN port of this machine.

For details on the cable connection port, refer to page 3-4.

Checking the network settings

Check that an IP address is assigned to this machine. Tap [Utility] - [Device Information], and check that an IP address is displayed.



Reference

If no IP address is displayed, you need to set up the network. For details, refer to page 5-3.

Installing the printer driver

Use the installer to install the printer driver on your computer.

- ✓ Administrator privileges are required to perform this task.
- 1** Insert the printer driver DVD into the DVD drive of the computer.
 - Make sure that the installer starts, and then go to Step 2.
 - If the installer does not start, open the printer driver folder on the DVD, double-click [Setup.exe] (in the 32-bit environment) or [Setup64.exe] (in the 64-bit environment), and then go to Step 3.
 - If the [User Account Control] window appears, click [Continue] or [Yes].
- 2** Click [Printer Install].
- 3** Read the license agreement, then click [AGREE].
- 4** Select your machine from [Product/Model], then click [Next].
- 5** Select [Install printers/MFPs], then click [Next].
 - In [Preference for IPv4] or [Preference for IPv6], you can specify the preferred address when a printer is detected using both the IPv4 address and IPv6 address.Connected printers are detected.
- 6** Select this machine, then click [Next].
 - If this machine is not detected, restart it.
 - You do not need to change the printing method from [Normal Printing] (Port 9100) unless otherwise specified by the administrator. This guide describes how to configure the [Normal Printing] (Port 9100) setting.
 - As a printing method, you can select [Normal Printing], [Internet Printing] (IPP), or [Secure Printing] (IPPS). For details on the printing method, refer to [Print] in the User's Guide CD/DVD.
 - Among the connected printers, only the target model is automatically detected and displayed. If multiple target models are displayed, check the IP addresses.
You can check the IP address of this machine in the screen that is displayed by tapping [Utility] - [Device Information].
 - If the connection to this machine cannot be recognized, it is not displayed in the list. In such a case, select [Specify the Printer/MFP Except for the Above. (IP Address, Host Name...)], and manually specify the IP address and host name of this machine.
- 7** Select the check box of the printer driver you want to install, then click [Next].
 - For features of each printer driver, refer to page 6-3.
 - In [Print Type Default Setting], you can select whether to install the driver that has 2-sided printing specified as the default, or to install the driver that has 1-sided printing specified as the default. By default, the driver that has 2-sided printing specified as the default is installed.
- 8** Check the items to be installed, and click [Install].

- 9 Change the printer name or print a test page if necessary, then click [Finish].

This completes the installation process of the printer driver.

Settings	Description
[Review]	Displays the installed components for checking.
[Rename Printer]	Changes this machine name if necessary.
[Property]	Sets the optional operating environment of this machine.
[Print Setting]	Changes the default print settings of this machine if necessary.
[Print Test page]	If necessary, print a test page to check that printing process works correctly.



Reference

When you finish installing the printer driver, configure the default settings of the printer driver. For details, refer to page 6-7.

6.1.3 Preparation for printing (USB connection)

Changing the installation settings (Windows 7/8.1/10/Server 2008 R2/Server 2012/Server 2012 R2/Server 2016)

In Windows 7/8.1/10/Server 2008 R2/Server 2012/Server 2012 R2/Server 2016, change the PC settings before installing the printer driver.

- 1 Open the [Control Panel] window.
 - In Windows 8.1/10/Server 2012/Server 2012 R2/Server 2016, while pressing the [Windows]  key, press the [X] key, and then click [Control Panel] in the displayed menu.
 - In Windows 7/Server 2008 R2, click the Start menu, then click [Control Panel].
- 2 Click [System and Security] - [System].
- 3 Click [Advanced system settings] on the menu to the left.
The [System Properties] screen appears.
- 4 In the [Hardware] tab, click [Device Installation Settings].
- 5 Select [No, let me choose what to do], select [Never install driver software from Windows Update.], then click [Save Changes].
 - After you have installed the printer driver, change the setting back to [Yes, do this automatically (recommended)].
- 6 Click [OK] to close the [System Properties] window.

Installing the printer driver

Use the installer to install the printer driver on your computer.

✓ Administrator privileges are required to perform this task.

- 1 Connect a USB cable to the USB port of this machine.
 - For details on the cable connection port, refer to page 3-4.
 - If a wizard screen appears to add new hardware, click [Cancel].
- 2 Insert the printer driver DVD into the DVD drive of the computer.
 - Make sure that the installer starts, and then go to Step 3.
 - If the installer does not start, open the printer driver folder on the DVD, double-click [Setup.exe] (in the 32-bit environment) or [Setup64.exe] (in the 64-bit environment), and then go to Step 4.
 - If the [User Account Control] window appears, click [Continue] or [Yes].
- 3 Click [Printer Install].
- 4 Read the license agreement, then click [AGREE].
- 5 Select your machine from [Product/Model], then click [Next].
- 6 Select [Install printers/MFPs], then click [Next].
Printers being connected via USB ports are detected.
- 7 Select this machine, then click [Next].
- 8 Select the check box of the printer driver you want to install, then click [Next].
 - For features of each printer driver, refer to page 6-3.
 - In [Print Type Default Setting], you can select whether to install the driver that has 2-sided printing specified as the default, or to install the driver that has 1-sided printing specified as the default. By default, the driver that has 2-sided printing specified as the default is installed.
- 9 Check the items to be installed, and click [Install].
- 10 Change the printer name or print a test page if necessary, then click [Finish].
This completes the installation process of the printer driver.

Settings	Description
[Review]	Displays the installed components for checking.
[Rename Printer]	Changes this machine name if necessary.
[Property]	Sets the optional operating environment of this machine.
[Print Setting]	Changes the default print settings of this machine if necessary.
[Print Test page]	If necessary, print a test page to check that printing process works correctly.



Reference

When you finish installing the printer driver, configure the default settings of the printer driver. For details, refer to page 6-7.

6.1.4 Initial settings of the printer driver

When you use this machine for the first time, configure the printer driver so that it contains information such as what options are installed in this machine and whether authentication settings have been configured.

- 1 Display the printer window.
 - In Windows 8.1/10, while pressing the [Windows] (⊞) key, press the [X] key, and then click [Control Panel] - [Hardware and Sound] - [View devices and printers] in the displayed menu.
 - In Windows Server 2012/Server 2012 R2/Server 2016, while pressing the [Windows] (⊞) key, press the [X] key, and then click [Control Panel] - [Hardware] - [View devices and printers] in the displayed menu.
 - In Windows 7/Server 2008 R2, click the Start menu, then click [Devices and Printers].
 - In Windows Server 2008, click the Start menu, then click [Control Panel] - [Hardware and Sound] - [Printers].
- 2 Open the printer properties.
 - In Windows 7/8.1/Server 2008 R2/Server 2012/Server 2012 R2/Server 2016, right-click the icon of the installed printer, and from [Printer properties], click the displayed printer name.
 - In Windows Server 2008, right-click the icon of the installed printer, then click [Properties].The [Properties] screen appears.
- 3 In the [Configure] tab, configure the information such as what options are installed in this machine and whether authentication settings have been configured.
 - By default, [Auto] in [Obtain Settings...] is enabled. The information on this machine is automatically obtained and reflected to [Device Option].
 - If the [Auto] of [Obtain Settings...] is disabled and if you click [Obtain Device Information], the current information of this machine is obtained and reflected on the [Device Option].
 - If communication with this machine fails, set the [Device Option] manually. Select an item to change from the list, and set a value in the [Setting].
- 4 Click [OK].

6.1.5 How to print

- 1 Open data of the original using the application software. From the [File] menu, select [Print].
- 2 In [Printer Name] (or [Select Printer]) make sure that the desired printer has been selected.
 - The [Print] dialog box varies depending on the application software.
- 3 Specify the print range and the number of copies to print.
- 4 Click [Properties] (or [Preferences]) to change the print settings of the printer driver, if necessary.
 - The print settings you have changed here return to the default values when you exit the application software.
 - For details on the print settings of the printer driver, refer to [Print] in the User's Guide CD/DVD.
- 5 Click [Print].

Printing is executed.

6.2 Using the scan function

6.2.1 Available operations in the scan function

The scanned original data can be sent to a computer or server, and saved on the hard disk (User Box) of this machine.

The Scan-to-Send Function provides the following sub-functions.

Function	Description
Scan to E-mail	Sends a converted file to any E-mail address as an E-mail attachment.
SMB Send	Sends a converted file to a shared folder of a computer. To use this function, specify your computer or file server as a destination.
FTP Send	Sends a converted file to the FTP server. This function is useful when transferring a file through the FTP server.
WebDAV Send	Sends a converted file to the WebDAV server. This function is useful when transferring a file through the WebDAV server.
Save in User Box	Saves the original data scanned by this machine in a User Box of this machine. The original data saved in a User Box can be sent to a shared folder or sent as an E-mail attachment.
WS scan	Imports original data by issuing a scan instruction from a computer without configuring complicated system settings, or sends original data scanned by this machine to a computer. This function is supported by Windows.
TWAIN scan	Converts original data scanned by this machine into a file, and imports it from a computer on the network using applications compatible with a TWAIN device.
Scan server sending	Sends a converted file to a scan server. When receiving a file, a scan server sends it as an E-mail attachment based on a workflow, or saves it in a shared folder of a computer.
Panel Link Scan	Sends the original data scanned on this machine to the storage of the terminal or the Google Drive. This function, which is the Panel Link function of bizhub Remote Access , is available when this machine is remotely operated from an Android/iOS terminal.



Reference

It may be necessary to make the following settings prior to use the Scan Function. For details on how to use each function, refer to [Scan] in the User's Guide CD/DVD.

6.2.2 How to send

- 1 Load the original.

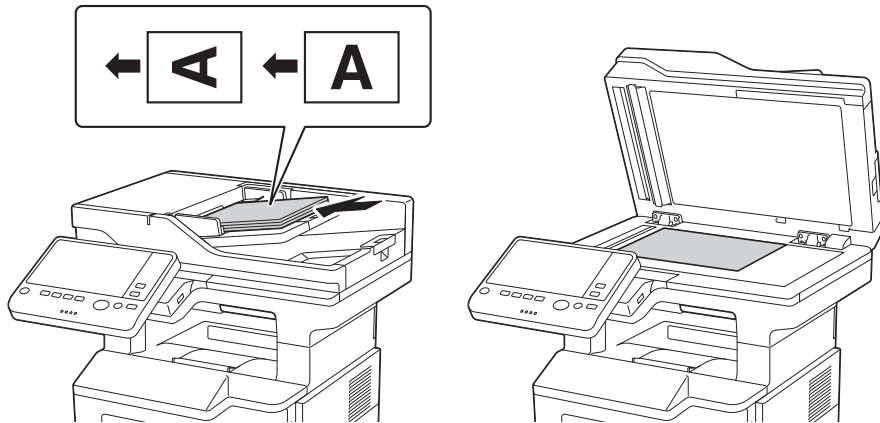

- 2 Tap [Scan] or [Scan/Fax].



- 3 Specify the destination.

- You can select the desired destination from the pre-registered destination list, or directly enter destination information. For details on how to register a destination, refer to page 6-21.
- Specifying multiple destinations carries out computer sending and fax transmission simultaneously.

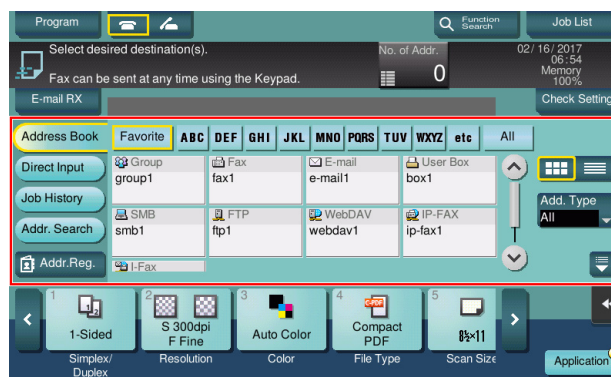

- 4 Specify the size of the original to be scanned.
 - The size of the original can be specified in [Scan Size] (default: [8-1/2 × 11] (inch area)/[A4] (centimeter area)). If you fail to set the original size correctly, the image may be cut off.
- 5 Configure Scan option settings as necessary.
 - For details on option settings, refer to [Scan] in the User's Guide CD/DVD.
- 6 Press the **Start** key.
 - If necessary, tap [Check Setting] before sending, and check the specified destination and settings.
 - To redo operations for specifying destinations or option settings, press the **Reset** key.



Transmission begins.

- If you press the **Stop** key while scanning an original, the scanning process stops, and a list of stopped jobs appears. To cancel scanning of the original, delete inactive jobs from the list.

6.3 Using the fax function

6.3.1 Fax function

The Fax is a communication function that uses a telephone line to send scanned originals (paper) or to receive data sent from remote machines. This machine has various features for fax operations, including those enabling the user to change scan settings according to the original and to save incoming faxes in a User Box.

The following describes the precautions for using the fax functions.

- To use the fax functions, the optional **Fax Kit** is required.
- This machine can connect to the following telephone lines.
 - Subscribed telephone lines (including facsimile communication networks)
 - PBX (Private Branch Exchange, 2-wire)
- Fax data cannot be sent or received in color.
- You cannot connect a business phone as an external telephone.
- If a digital dedicated line is multiplexed in an enterprise network, fax transmission speed may be limited, or the Super G3 fax may not be available.
- Communication error may occur on rare occasions due to the factory default setting. This is because the multiplex device limits the frequency band of the line to the utmost limit based on the assumption that the line is intended for voice communication. Also, these restrictions differ depending on the device that make up the network. For details, contact your network administrator.



Reference

To use the fax function, the operating environment must be configured on this machine in advance. For details, refer to page 5-4.

6.3.2 How To Send

- 1 Load the original.

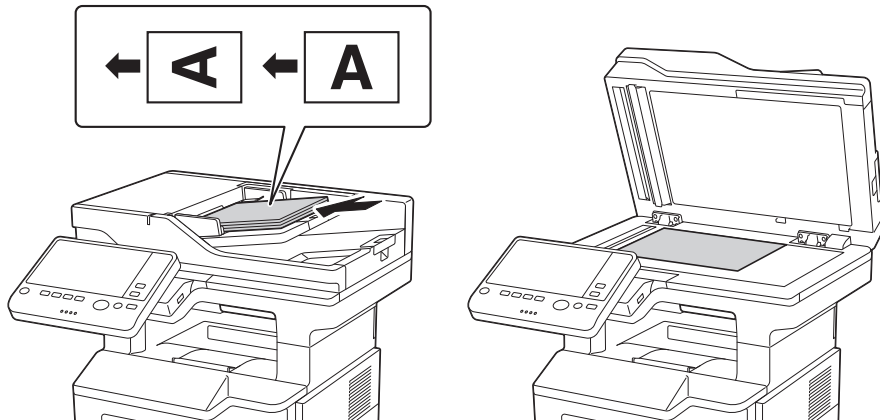

- 2 Tap [Scan/Fax].



- 3 Enter a fax number.

- You can select the desired destination from the pre-registered destination list, or directly enter destination information. For details on how to register a destination, refer to page 6-21.
- Specifying multiple destinations carries out computer sending and fax transmission simultaneously.



- 4 Specify the size of the original to be scanned.
 - The size of the original can be specified in [Scan Size] (default: [8-1/2 × 11] (inch area)/[A4] (centimeter area)). If you fail to set the original size correctly, the image may be cut off.
- 5 Configure the option settings for fax transmission as necessary.
 - For details on optional settings, refer to [Fax] in the User's Guide CD/DVD.
- 6 Press the **Start** key.
 - Tap [Check Setting] before sending, and check the destination and settings as necessary.
 - To redo operations for specifying destinations or option settings, press the **Reset** key.



- If the screen to confirm the specified destination or settings appears, check the contents, then tap [Send].
 - If the keyboard screen appears, enter the specified password, then tap [Send]. For the password, contact the administrator of this machine.
- Transmission begins.
- If you press the **Stop** key while scanning an original, the scanning process stops, and a list of stopped jobs appears. To redo scanning of the original, delete the job from the list of inactive jobs.

6.3.3 Introduction of fax transmission function

This section describes convenient fax transmission functions. For details on how to use each function, refer to [Fax] in the User's Guide CD/DVD.

Function	Overview
Timer TX	Timer TX automatically starts sending at a specified time if the time is pre-specified.
Check Dest. & Send	Check Dest. & Send checks the fax number specified for the fax transmission against the destination fax number (CSI) and sends the fax only when they match.
F-Code TX	F-Code TX specifies the F code (SUB address and sending ID) to send a fax. Confidential communication and relay distribution are available. <ul style="list-style-type: none"> • The confidential communication function is designed to communicate with specific people using a Confidential RX User Box that requires a registered number and a password. • The Relay Distribution function sends a fax to a relay machine, which distributes the received fax to a pre-registered group of destinations.
Quick Memory TX	Fax transmission starts concurrently with scanning one page. The total number of pages transmitted can be entered in the sender record.
International Transmission Mode	This function reduces the transmission speed (the information transfer speed) for sending a fax. It is useful when sending a fax to areas where communication conditions are poor.
Password TX	Password TX sends a fax with a password. It is used to send faxes to a device on which fax peers are restricted by passwords (a device with Closed Network RX enabled).
Polling TX	Polling TX stores a file beforehand on the internal hard disk and sends it out upon a request for reception (polling request) from the recipient.

6.3.4 Introduction of fax receiving function

This section describes the convenient fax receiving functions. For details on how to use each function, refer to [Fax] in the User's Guide CD/DVD.

Function	Overview
In-memory proxy reception	When the machine cannot print a received fax due to paper jam or exhaustion of consumables, this function stores the received fax in memory until this machine is ready to print.
TSI Routing	This function automatically sorts incoming faxes into preset boxes or redirects them to shared folders in computers or E-mail addresses based on the fax numbers of the senders.
Forward TX	This function transfers a received fax to a pre-specified destination.
Memory RX	This function saves a received fax to the Memory RX User Box of this machine. You can check the contents of the received fax and print out only the required one.
Confidential RX	This function is designed for communications with specific people using a Confidential User Box that requires a registered number and a password.
Relay RX	This function sends a fax to a relay machine, which distributes the received fax to a pre-registered group of destinations.
Closed Network RX	Closed Network RX restricts the peers by passwords.
Polling RX	Polling RX receives a polling file saved in a sending machine as instructed from this machine.
PC-Fax RX	This function automatically saves a received fax to the Memory RX User Box or a User Box specified in F-Code (SUB Address). The saved fax can be printed or downloaded, if necessary.
Night RX	Night RX prohibits printing of faxes received in the pre-specified nighttime zone.

6.3.5 Introduction of internet fax function

Internet fax is a function used to send and receive fax via enterprise network and Internet.

The same network as the one used by the computers is used to transmit faxes. Therefore, you can send and receive faxes to/from distant locations without having to worry about high communication costs or sending a large number of pages.

For details on the Internet fax function, refer to [Network Fax] in the User's Guide CD/DVD.

6.3.6 Introduction of IP address fax function

IP Address Fax is a function that sends and receives faxes within a limited network such as an intranet.

Specify an IP address for the destination. This function uses the same network as a computer, offering lower communication expenses than those incurred for normal fax transmission.

In addition to IP address, you can also use a host name and E-mail address to specify the destination.

For details on the IP address fax function, refer to [Network Fax] in the User's Guide CD/DVD.

Tips

- To use the IP Address Fax function, the optional **Fax Kit** is required.

6.4 Using the copy function

6.4.1 How to copy

- 1 Load the original.

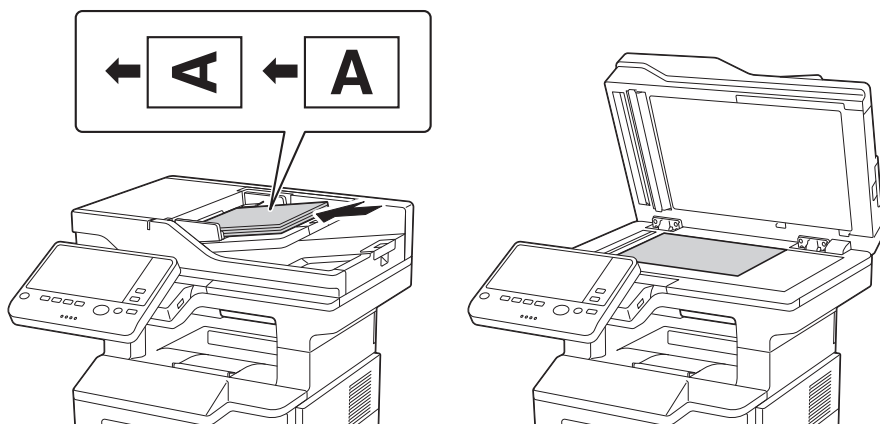

- 2 Tap [Copy].

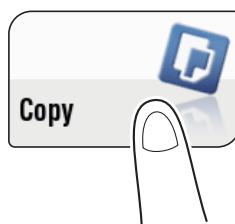

- 3 Specify the size of the original to be scanned.
 - The size of the original can be specified in [Original Settings] (default: [8-1/2 × 11] (inch area)/[A4] (centimeter area)). If you fail to set the original size correctly, the image may be cut off.

- 4 If necessary, configure copy settings.
 - The setting change is reflected on the image of [Output]. Therefore, you can configure the settings while checking the output image.
 - To reconfigure settings, press the **Reset** key.

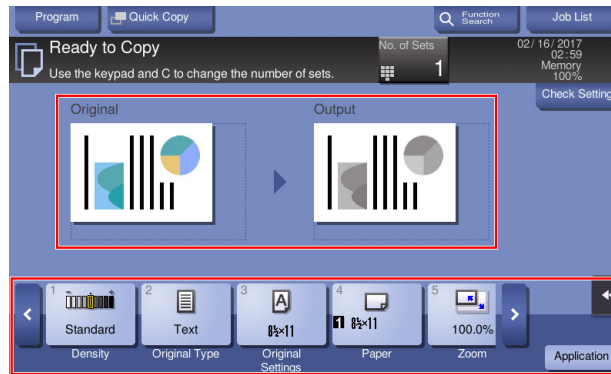

- For details on copy settings, refer to page 6-17.

- 5 If necessary, specify the number of copies using the **Keypad**.
 - Tapping [No. of Sets] displays the **Keypad**.
 - Pressing the **10 Keypad** key (default: Register key 3) displays the **Keypad** on the **Touch Panel**, enabling you to enter numeric values.
 - To change the number of copies, tap [C] (Clear).
- 6 Press the **Start** key.
 - If desired, tap [Check Setting] before starting a copy, and check the settings.



The original is scanned and copy begins.

- If you press the **Stop** key while scanning or printing an original, processing is stopped, and a list of inactive jobs is displayed. To cancel the operation, delete the stopped jobs from the list.
- If [Ready to accept another job.] appears while printing a job, you can scan the next original.

6.4.2 Introduction of copy function

This section describes the convenient copy functions. For details on how to use each function, refer to [Copy] in the User's Guide CD/DVD.

Function	Overview
[Interrupt]	If you urgently want to make a copy, even if the machine is printing an original, you can interrupt the active job and make an intruder copy.
Proof Copy	Before beginning actual copying, do a single test copy and check it is acceptable. When making a large number of copies, use the proof copy function to prevent a large number of copy errors from occurring.
[Density]	Adjust the density of a copy image.
[Original Type]	Select the optimum settings for the original to copy it in the optimum image quality.
[Original Settings]	Select the size of the original to be scanned.
[Paper]	Select the paper size and type for copying. You can also change the size and type settings of the paper loaded in paper trays.
[Zoom]	Copy an original image enlarged or reduced by an arbitrary zoom ratio.
[Duplex/Combine]	Copy an original onto both sides of the paper. A multi-page original can be reduced and copied on the same side of a single sheet of paper.
[Finishing]	<ul style="list-style-type: none"> [Group/Sort]: Select whether to sort the output sheets or group them when printing multiple sets of copies. [Staple]: Staple each set of copies at a corner. To use this function, the optional Finisher is required.
[Book Original]	You can copy two-page spreads such as books and catalogs separately into the left and right pages, or copy as one page.
[Page Separation]	Copy two-page spreads, such as a catalog with the staples removed, separately into the left and right pages.
[Separate Scan]	If the number of original sheets is so large that they cannot be loaded into the ADF at the same time, you can load them in several batches and handle them as one job.
[Bkgd. Removal]	Adjust the density of the background area when copying originals with colored background (newsprints, recycle paper, etc.) or originals that are so thin that text or images on the back would be scanned.
[Text Enhancement]	Either of photos or text is enhanced when text is superimposed over photos (figure, graph, etc.).
[Neg-/Pos. Reverse]	Copy the original with the density (gradations) and color of the image inversed. The finished image looks like a negative print photo.
[Image Adjustment]	Copy after adjusting the image quality (contrast, copy density).
[Booklet]	The pages in the original data are arranged and spread in a booklet format and printed on both sides of sheets.
[Page Margin]	You can add a margin for binding copied sheets. Set a binding position and a margin for each page.
[Image Shift]	You can fine tune the image position by shifting it in a horizontal or vertical direction according to the paper size.
[Mirror Image]	Copy the original image by reversing its left and right, like a reflection image on the mirror.
[Image Repeat]	Copy an original image repeatedly copied onto the same side of a single sheet.
[Image Adjust]	Copy while placed at the center of paper with the original size unchanged.
[Cover Sheet]	You can insert a cover sheet before the first page or after the last page of the text.
[Insert Sheet]	You can insert a sheet that is of a different type from other pages (such as color and thick papers) for a specified page.
[Insert Image]	The original scanned using the Original Glass is inserted after the page you have specified in the original scanned using the ADF .

Function	Overview
[Chapters]	When an original is copied onto both sides of sheets of paper, the first page of each chapter is always printed on the front side of paper.
[Date/Time]	Add a date and time to make a copy.
[Page Number]	Add page and chapter numbers on copied sheets.
[Stamp]	Text such as "PLEASE REPLY" and "DO NOT COPY" are printed on the first page or all pages.
[Stamp Repeat]	Stamp such as "Copy" and "Private" are printed on the entire page.
[Header/Footer]	Add the date, time and any other desired text in the top and bottom margins (header/footer) of the specified page.
[Watermark]	Add text such as "COPY" or "Confidential" in the center of each page in a tint color to make a copy.
[Overlay]	The original image scanned in the first page is overlaid on the originals scanned in the subsequent pages.
[Registered Overlay]	In [Register Overlay Image], register original images to the hard disk of this machine as overlay image. You can call a registered overlay image and compose it on an original that is scanned later.
[Copy Protect]	Text such as "Copy" and "Private" are printed in the background pattern as concealed text.
[Frame Erase]	Erases the four sides of the original by the same width amount. You can also specify the width to be erased for each side.
[Non-Image Area Erase]	When making copies with the ADF open and the original placed on the Original Glass , the machine detects the outline of the original and erases shadows outside the original.
[Save in User Box]	Save original images in the hard disk (user box) of this machine. You can also save an original in a user box and print at the same time.
[Program Jobs]	Originals are scanned with different settings for each set, and copied collectively.
[Card Shot]	When you want to copy cards, you can arrange the front and back sides of the card on the same side of a single page and print them onto one sheet.

6.5 Printing a file stored on USB memory

Supported USB memory devices

USB memory devices that have the following specifications can be connected to this machine.

Item	Requirement
Interface	Compatible with USB Version 2.0/1.1 interface
Format type	Formatted in FAT32
Security	Securities such as data encryption and password lock shall be released, or the security function shall be turned Off.
Memory size	No upper limit. <ul style="list-style-type: none"> Some USB memory devices may not be supported. A USB memory device, which is recognized as multiple drives, cannot be used.

Tips

Note the following points when connecting a USB memory device to this machine.

- Use the USB connector on the side that is near the **Control Panel**.
- Do not disconnect the USB memory device while saving a file to the device or printing a file saved in the device.
- Do not use USB devices (such as hard disk unit and a USB switching hub) except for a USB memory.
- Do not connect or disconnect the USB memory when the hourglass is being displayed in the **Control Panel** while this machine is active.
- Do not disconnect the USB memory directly after connecting it.

How to print

Any of PDF, Compact PDF, JPEG, TIFF, XPS, Compact XPS, OOXML (.docx/.xlsx/.pptx), and PPML (.ppml/.vdx/.zip) format files can be printed out.

Tips

- You can also print out encrypted PDF and outline PDF files.
- A 1200-dpi resolution file is printed in the 600 × 600-dpi resolution.

- 1 Connect a USB memory device to the USB port of this machine.

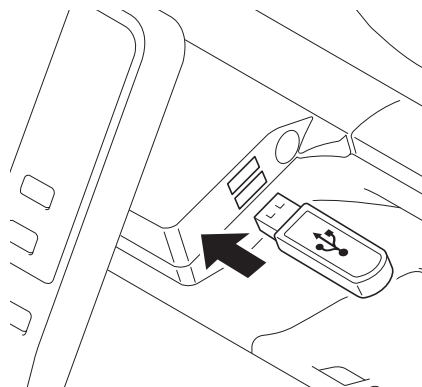

NOTICE

When this machine is starting up, do not insert or remove the USB memory device to/from the USB port.

2 Tap [Print a document from External Memory].

→ You can also print files by selecting the User Box mode and by tapping [System] - [External Memory].

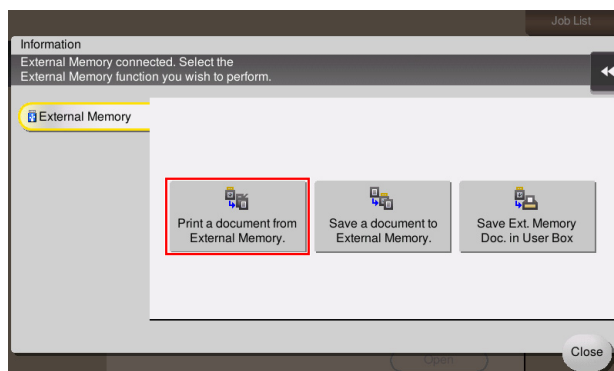

3 Select a file to print, then tap [Print].

→ You can directly enter the path to the file folder in the [File Path] field.

→ Tap [Top] to move upward.

→ Tap [Open] to open the folder and move downward.

→ Tap [Details] to display and check the detailed file information.

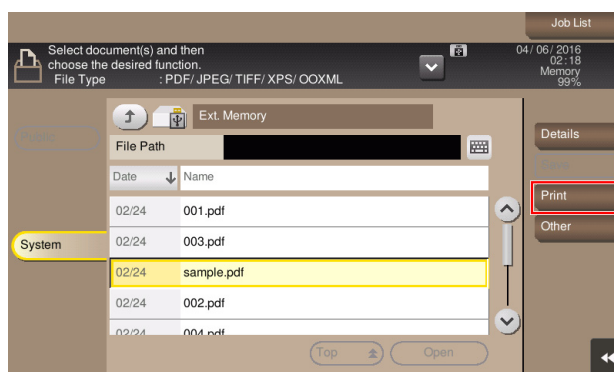

4 Set print options if necessary.

→ For details on optional settings, refer to [User Box] in the User's Guide CD/DVD.

5 Press the **Start** key.

Printing starts.

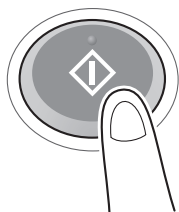

6 When printing is complete, remove the USB memory device from the port of this machine.

6.6 Registering a destination

6.6.1 Address book

Registering a frequently used destination on this machine will save you the trouble of having to enter it each time you send data. A destination registered on this machine is called an Address Book.

You can register up to 2000 one-touch destinations in the address book. The destination types that can be registered are E-mail address, computer name, etc. depending on the transmission mode.



Reference

Address books can also be registered using **Web Connection**. For details on how to register, refer to [Web Management Tool] in the User's Guide CD/DVD.

6.6.2 Registering address books

Registering from the Utility

- 1 Tap [Utility], then select [One-Touch/User Box Registration].
- 2 Select [Create One-Touch Destination] - [Address Book (Public)].
- 3 Select the type of destinations to register, then tap [New].
- 4 Configure respective items, then tap [OK].

Common settings	Description
[No.]	Use the Keypad to enter the registration number for a one-touch destination. If no number is entered, the smallest number available is assigned to the destination.
[Name]	Enter the registration name for the one-touch destination. You can enter up to 24 characters.
[Sort Character]	Enter the same name as the one registered. You can enter up to 24 characters. You can sort destinations by registration name.
[Index]	Select a search text. Destinations are displayed on the top screen in the fax/scan mode as sorted by index specified here. For a frequently used destination, specify the index characters and select [Favorites] at the same time. This allows you to find it more easily.

The registered content of [Fax]

Settings	Description
[Fax Number]	<p>Enter a destination fax number.</p> <ul style="list-style-type: none"> • When you use this machine in a PBX environment, tap [Outside] ([E-] appears). A registered outside line number is automatically inserted. • When you use this machine in a PBX environment, tap [Pause] following the outside line number ([P] appears) to ensure the dialing is successful. • If you want to send out a push signal over the dial line, tap [Tone] ([T] appears). • Tap [-] to separate a dial number. It does not affect the dialing of the number.
[Line Settings]	<p>If necessary, specify how to send a fax to a destination you want to register. You may change the settings you made here before sending a fax.</p> <ul style="list-style-type: none"> • [Overseas TX]: Used to send a fax to areas where communication conditions are poor. Faxes are sent at a lower speed. • [ECM OFF]: ECM is an error correction mode defined by ITU-T (International Telecommunication Union - Telecommunication Standardization Sector). Fax machines equipped with the ECM feature communicate with each other, confirming that the sent data is free of errors. This prevents image blurring caused by telephone line noise. The communication time can be reduced by setting ECM to OFF for transmission. However, an image error or communication error may occur depending on the specified communication time value, so change the value to suit conditions. • [V34 OFF]: V.34 is a communication mode used for super G3 fax communication. When the remote machine or this machine is connected to a telephone line via PBX, however, you may not establish a communication in the super G3 mode depending on telephone line conditions. In this case, it is recommended that you turn the V.34 mode off to send data. • [Check Dest. & Send]: When using the Check Dest. And Send function, select [Yes]. The fax number specified for fax is checked against the destination fax number (CSI) and the fax is sent only when they match.

The registered content of [E-Mail]

Settings	Description
[E-Mail Address]	<p>Enter the E-mail address as a destination.</p> <p>If prefixes and suffixes are registered, you can recall a registered domain name etc. to complement entry.</p>

The registered content of [PC (SMB)]

Settings	Description
[User ID]	<p>Enter the name of a user who has privileges to access the folder specified in [File Path] (using up to 64 characters).</p> <ul style="list-style-type: none"> • For workgroup user, only type in only the user name. Entry example: "User01" • For domain user, type in user-name@domain-name. Entry example: "User01@abc.local"
[Password]	Enter the password of the user specified in [User ID].
[Host Address]	<p>Enters the destination computer name (host name) or IP address (using up to 253 bytes).</p> <ul style="list-style-type: none"> • Example of computer name (host name) entry: "HOME-PC" • Example of IP address (IPv4) entry: "192.168.1.1" • Example of IP address (IPv6) entry: "fe80::220:6bff:fe10:2f16"
[Check Connection]	Check whether or not the host name you entered in [Host Address] exists.
[File Path]	<p>Enter the shared folder name of the computer specified in [Host Address] (using up to 255 bytes). The shared folder name is generally referred to as a share name.</p> <ul style="list-style-type: none"> • Entry example: "scan" <p>When specifying a folder in the shared folder, insert a symbol, "\", between folder names.</p> <ul style="list-style-type: none"> • Entry example: "scan\document"

Settings	Description
[Host Name Search]	<p>Searches for the host name to be applied to [Host Address]. To search for the host name, specify a group name.</p> <ul style="list-style-type: none"> [Group Name]: Displays the name of the group to which the user belongs by default. To change the group name, tap [Change], then enter the group name (using up to 15 characters). After entering the group name, specify search conditions, then tap [Search]. [Host Name]: Enter the target host name (using up to 15 characters). After entering the host name, specify search conditions, then tap [Search].
[Reference]	<p>On the Touch Panel, search for a computer to send a file to, and select a target shared folder.</p> <p>When the authentication screen appears, enter the name and password of a user who has privileges to access the selected folder. After authentication, [Host Address] or [File Path] is entered automatically.</p> <p>The Reference function may fail under the following conditions.</p> <ul style="list-style-type: none"> If 512 or more workgroups or computers are on the network (subnet) connected to this machine, this function may fail. This function is not available in the IPv6 environment.

The registered content of [FTP]

Settings	Description
[Host Address]	<p>Enter the host name or IP address of the destination FTP server (using up to 253 bytes).</p> <ul style="list-style-type: none"> Example of host name entry: "host.example.com" Example of IP address (IPv4) entry: "192.168.1.1" Example of IP address (IPv6) entry: "fe80::220:6bff:fe10:2f16"
[File Path]	<p>Enter the name of a destination folder in the FTP server specified in [Host Address] (using up to 127 bytes).</p> <ul style="list-style-type: none"> Entry example: "scan" <p>When specifying a folder in the FTP folder, insert a symbol, "/", between the folder names.</p> <ul style="list-style-type: none"> Entry example: "scan/document" <p>When not specifying a file path, enter only "/".</p> <ul style="list-style-type: none"> Entry example: "/"
[User ID]	<p>If authentication is required in the destination FTP server, enter the available user name to log in (using up to 64 characters).</p>
[Password]	<p>Enter the password of the user specified in [User ID].</p>
[anonymous]	<p>When authentication is not required in the destination FTP server, select [ON]. [OFF] is specified by default.</p>
[PASV]	<p>When the PASV mode is used in your environment, select [ON]. [OFF] is specified by default.</p>
[Proxy]	<p>When a proxy server is used in your environment, select [ON]. [OFF] is specified by default.</p>
[Port No.]	<p>If necessary, change the port number.</p> <p>In normal circumstances, you can use the original port number. [21] is specified by default.</p>

The registered content of [WebDAV]

Settings	Description
[User ID]	Enter the name of a user who has privileges to access the folder specified in [File Path] (using up to 64 characters).
[Password]	Enter the password of the user specified in [User ID].
[Host Address]	Enter the host name or IP address of the destination WebDAV server (using up to 253 bytes). <ul style="list-style-type: none"> • Example of host name entry: "host.example.com" • Example of IP address (IPv4) entry: "192.168.1.1" • Example of IP address (IPv6) entry: "fe80::220:6bff:fe10:2f16"
[File Path]	Enter the name of a destination folder in the WebDAV server specified in [Host Address] (using up to 142 bytes). <ul style="list-style-type: none"> • Entry example: "scan" When specifying a folder in the WebDAV folder, insert a symbol, "/", between the folder names. <ul style="list-style-type: none"> • Entry example: "scan/document"
[Proxy]	When a proxy server is used in your environment, select [ON]. [OFF] is specified by default.
[SSL Setting]	When SSL is used in your environment, select [ON]. [OFF] is specified by default.
[Port No.]	If necessary, change the port number. In normal circumstances, you can use the original port number. [80] is specified by default.

The registered content of [IP Address Fax]

Settings	Description
[Destination]	Enter the destination IP address or host name. <ul style="list-style-type: none"> • Example of IP address (IPv4) entry: "192.168.1.1" • Example of IP address (IPv6) entry: "fe80::220:6bff:fe10:2f16" • Example of host name entry: "host.example.com" (Also enter a domain name.) You can also specify a destination by E-mail address. To specify a destination by E-mail address, enter the destination IP address or host name following "ipaddrfax@". To enter an IP address following the @ symbol, put the IP address in brackets "[]". <ul style="list-style-type: none"> • Example of IP address (IPv4) entry: "ipaddrfax@[192.168.1.1]" To enter an IP address (IPv6), enter "IPv6:" following left bracket "[". <ul style="list-style-type: none"> • Example of IP address (IPv6) entry: "ipaddrfax@[IPv6:fe80::220:6bff:fe10:2f16]" To enter a host name following the @ symbol, brackets "[]" are unnecessary. <ul style="list-style-type: none"> • Example of host name entry: "ipaddrfax@host.example.com"
[Port Number]	If necessary, change the port number. In normal circumstances, you can use the original port number. [25] is specified by default.
[Destination Machine Type]	Select whether the recipient machine supports color print. [Monochrome] is specified by default.

The registered content of [Internet Fax]

Settings	Description
[E-Mail Address]	Enter the E-mail address as a destination. If prefixes and suffixes are registered, you can recall a registered domain name etc. to complement entry.
[RX Ability (Destination)]	Select the specifications of original data that the recipient machine can receive in [Compression Type], [Paper Size] and [Resolution].

Tips

- To check the settings for a registered destination, select its registered name, then tap [Check Job Set.].
- To change the settings for a registered destination, select its registered name, then tap [Edit].
- To delete a registered destination, select its registered name, then tap [Delete].
- To use the [Fax] or [IP Address Fax] function, the optional **Fax Kit** is required.

Registering from Address Book

- 1 Tap [Address book] on the main menu.



- 2 Tap [New].

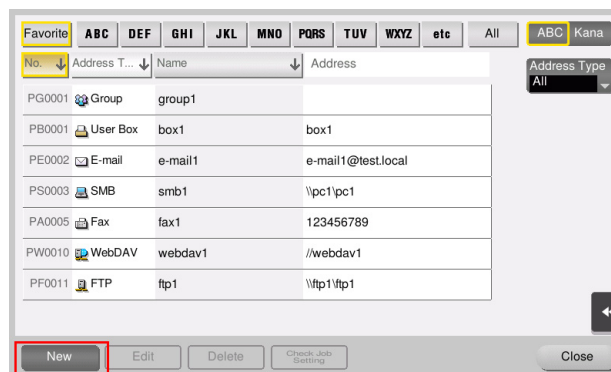

- 3 Select the type of the destination you want to register from [Address Type].
- 4 Enter destination information, then tap [Register].
 - The registered information is the same as that to be registered from the Utility. For details, refer to page 6-21.

Registering from the Fax/Scan basic screen

- 1 Tap [Scan/Fax].



- 2 Tap [Address Reg.].



- 3 Tap [New], then tap the type of the destination you want to register.

- 4 Enter destination information, then tap [Register].

→ The registered information is the same as that to be registered from the Utility. For details, refer to page 6-21.

7

Index

7 Index

A

Address Book 6-21

B

Bypass Tray 4-6

C

Control Panel 3-10

Copy Function 6-15

How to Copy 6-15

Introduction of Copy Function 6-17

D

Destination Registration 6-21

E

Entering Characters 3-19

F

Fax Function 6-11

Introduction of Receiving Function 6-14

Introduction of Transmission Function 6-13

Overview 6-11

Preparation 5-4

I

Internet Fax Function 6-14

IP Address Fax Function 6-14

K

Keypad 3-15

L

Loading Paper

Bypass Tray 4-6

Tray 1 4-8

M

Main Menu 3-17

N

Name of parts 3-3

Front 3-3

Side/rear 3-4

Network Setting 5-3

O

Option Configuration 3-5

P

Paper

Available Paper Sizes 4-4

Available Paper Types 4-3

Storing Paper 4-5

Unavailable Paper 4-4

Power Supply 3-7

Power Key 3-8

Power Switch 3-8

Preparation

Fax 5-4

Network Setting 5-3

Print (Network Connection) 6-3

Print (USB Connection) 6-5

Print Function 6-3

How to Print 6-7

Printer Driver 6-3

Initial Settings 6-7

Install (Network Connection) 6-3

Install (USB Connection) 6-5

S

Scan Function

How to Send 6-9

Overview 6-8

T

Text Entry 3-16

Touch Panel

Operation 3-12

Precautions for Correct Operations 3-16

Tray 1 4-8

U

USB Memory 6-19

How to Print 6-19

User's Guides 2-4

