



Online User's Guide

ADS-2200

ADS-2700W

Table of Contents

Before You Use Your Brother Machine	1
Definitions of Notes	2
Trademarks	3
Important Note	4
Introduction to Your Brother Machine	5
About This Machine	6
Set Up Your Scanner.....	7
Control Panel Overview	8
Touchscreen LCD Overview.....	10
Paper Handling	13
Document Specifications.....	14
Acceptable Documents	15
Unacceptable Documents	16
Carrier Sheet Recommendations	20
Notes for Using Carrier Sheets	21
Load Documents	22
Load Standard Size Documents.....	23
Load Business Cards	25
Load a Plastic Card	26
Load Documents Longer than Standard Size	27
Load Non-standard Size Documents	28
Load Receipts, Clippings, Photos, and Other Documents	30
Scan	32
Before Scanning.....	33
Scan Using the Scan Button on Your Brother Machine	34
Save Scanned Documents on Your Computer.....	35
Save Scanned Documents to a USB Flash Drive	38
Send Scanned Data to an Email Server.....	42
Set Up the Address Book	44
Scan to FTP	47
Scan to SFTP	51
Scan to Network	55
Web Services for Scanning on Your Network (Windows® 7, Windows® 8 and Windows® 10).....	59
Scan Options Using the Touchscreen	63
Restrict Scan Functions from External Devices	64
Scan from Your Computer (Windows®)	65
Scan Using Nuance™ PaperPort™ 14 or Other Windows® Applications	66
Scan Using Windows® Photo Gallery or Windows® Fax and Scan	73
Scan from Your Computer (Mac).....	77
Scan Using Brother iPrint&Scan	78
Scan Using TWAIN-Compliant Applications (Mac).....	79
Scan Using Apple Image Capture (ICA Driver)	82
Network	86
Supported Basic Network Features	87

Network Management Software and Utilities	88
Learn about Network Management Software and Utilities	89
Additional Methods of Configuring Your Brother Machine for a Wireless Network	90
Before Configuring Your Brother Machine for a Wireless Network.....	91
Configure Your Machine for a Wireless Network Using the One-Push Method of Wi-Fi Protected Setup™ (WPS).....	92
Configure Your Machine for a Wireless Network Using the PIN Method of Wi-Fi Protected Setup™ (WPS).....	93
Configure Your Machine for a Wireless Network Using the Machine's Control Panel Setup Wizard .	95
Use Wi-Fi Direct®	97
Advanced Network Features.....	107
Synchronize Time with the SNTP Server Using Web Based Management	108
Technical Information for Advanced Users.....	113
Wireless LAN Error Codes	114
Security	115
Lock the Machine Settings	116
Setting Lock Overview.....	117
Network Security Features.....	120
Secure Function Lock 3.0.....	121
Manage Your Network Machine Securely Using SSL/TLS.....	125
Send an Email Securely	129
Troubleshooting	131
Error and Maintenance Messages	132
Error and Maintenance Indications	136
Service Call Indications	138
Document Jam	139
If You Are Having Difficulty with Your Machine	141
Scanning and Other Problems	142
Network Problems	146
Check the Serial Number	154
Reset Your Brother Machine	156
Reset the Usage Counters.....	157
Routine Maintenance	158
Clean Your Brother Machine	159
Clean the Outside of the Machine	160
Clean the Scanner and Rollers	162
Replace Supplies	165
Supplies.....	166
Check Supplies Replacement Cycle	167
Replace the Pick Up Roller	169
Replace the Brake Roller	171
Pack and Ship Your Brother Machine	173
Machine Settings.....	175
Change Machine Settings from the Control Panel.....	176
In the Event of Power Failure (Memory Storage).....	177
Change the General Settings from the Control Panel.....	178
Save Your Favorite Settings as a Shortcut.....	180



Change Machine Settings from Your Computer.....	183
Change Machine Settings Using Web Based Management	184
Change the Machine Settings Using Remote Setup	188
Appendix.....	197
Specifications	198
Enter Text on Your Brother Machine	203

Before You Use Your Brother Machine

- [Definitions of Notes](#)
- [Trademarks](#)
- [Important Note](#)

Definitions of Notes

We use the following symbols and conventions throughout this User's Guide:

 CAUTION	CAUTION indicates a potentially hazardous situation which, if not avoided, may result in minor or moderate injuries.
IMPORTANT	IMPORTANT indicates a potentially hazardous situation which, if not avoided, may result in damage to property or loss of product functionality.
NOTE	NOTE specifies the operating environment, conditions for installation, or special conditions of use.
	Tips icons indicate helpful hints and supplementary information.
Bold	Bold style identifies buttons on the machine's control panel or computer screen.
<i>Italics</i>	Italicized style emphasizes an important point or refers you to a related topic.
Courier New	Courier New font identifies messages shown on the machine's LCD.

Related Information

- [Before You Use Your Brother Machine](#)

Trademarks

Brother is either a trademark or a registered trademark of Brother Industries, Ltd.

Microsoft, Windows, Windows Server, Internet Explorer, Word, Excel and PowerPoint are either registered trademarks or trademarks of Microsoft Corporation in the United States and/or other countries.

Apple, Mac, Safari, iPad, iPhone, iPod touch and OS X and Safari are trademarks of Apple Inc., registered in the United States and other countries.

Nuance and PaperPort are trademarks or registered trademarks of Nuance Communications, Inc. or its affiliates in the United States and/or other countries.

Wi-Fi®, Wi-Fi Alliance® and Wi-Fi Direct® are registered trademarks of Wi-Fi Alliance®.

WPA™, WPA2™, Wi-Fi Protected Setup™ and Wi-Fi Protected Setup™ logo are trademarks of Wi-Fi Alliance®.

Android and Google Play are trademarks of Google, Inc. Use of these trademarks are subject to Google Permissions.

Adobe is a registered trademark or trademark of Adobe Systems Incorporated in the United States and/or other countries.

Each company whose software title is mentioned in this manual has a Software License Agreement specific to its proprietary programs.

Any trade names and product names of companies appearing on Brother products, related documents and any other materials are all trademarks or registered trademarks of those respective companies.



Related Information

- [Before You Use Your Brother Machine](#)

Important Note

- Go to your model's **Manuals** page on the Brother Solutions Center at support.brother.com, select your model number, and download your model's other manuals, including the *Quick Setup Guide*.
- Check support.brother.com for Brother driver and software updates.
- To keep your machine performance up to date, check support.brother.com for the latest firmware upgrade. Otherwise, some of your machine's functions may not be available.
- Do not use this product outside the country of purchase as it may violate the wireless telecommunication and power regulations of that country.
- Not all models are available in all countries.
- In this *User's Guide*, the illustrations of the ADS-2700W are used unless otherwise specified.
- The screens in this *User's Guide* are for illustration purposes only and may differ from the actual screens.
- Unless otherwise specified, the screens in this manual are from Windows® 7 and macOS v10.10.x. Screens on your computer may vary depending on your operating system.
- If the LCD messages, control panel button names, and other indications are different depending on the country, the indications for each country will be shown.
- The contents of this guide and the specifications of this product are subject to change without notice.



Related Information

- [Before You Use Your Brother Machine](#)

Introduction to Your Brother Machine

- [About This Machine](#)
- [Set Up Your Scanner](#)
- [Control Panel Overview](#)
- [Touchscreen LCD Overview](#)

About This Machine

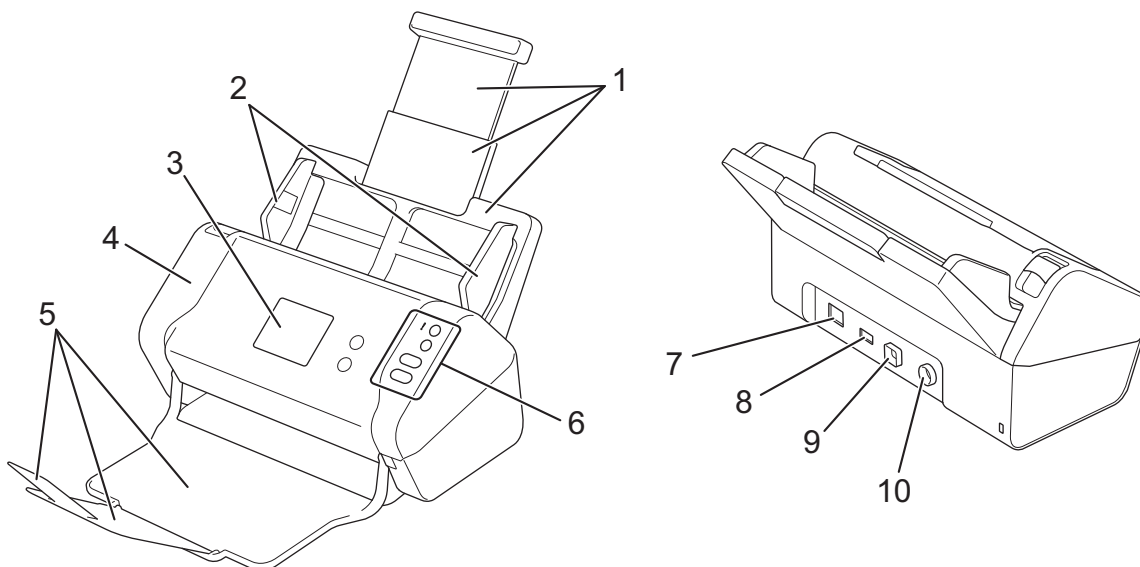

1. **Extendable Automatic Document Feeder (ADF)**
2. **Paper Guides**
3. **Touchscreen LCD (ADS-2700W)**
4. **Front Cover**
5. **Extendable Output Tray**
6. **Control Panel**
7. **Ethernet Cable Port (ADS-2700W)**
8. **USB 2.0 Port (for connecting a USB flash drive)**
9. **Hi-Speed USB 2.0 Port (for connecting to a computer)**
10. **AC Adapter Connector**



Related Information

- [Introduction to Your Brother Machine](#)

Set Up Your Scanner

1. Pull the Extendable Tray from the ADF.

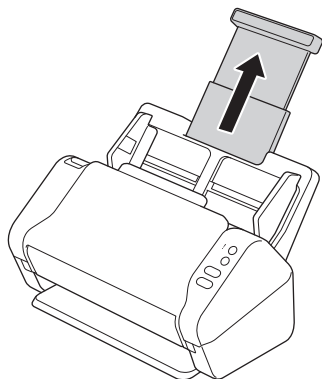

2. Open the Output Tray and extend it to match the length of the document pages.

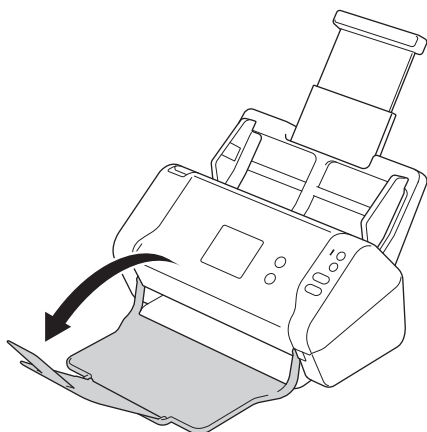

If the Output Tray is even slightly longer than the document size, pages may not be in their original order when you retrieve them from the Output Tray.

CAUTION

Do not use the ADF as a handle to carry the scanner.



Related Information

- [Introduction to Your Brother Machine](#)

Control Panel Overview

ADS-2200

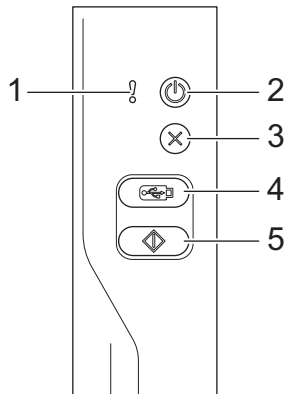

1. Error Indicator (with LED)

Blinks when the machine detects an error.

2.  (Power On/Off) (with LED)

Press  to turn on the machine.

Press and hold  to turn off the machine.

3.  (Stop)

Press to stop or cancel your current action and return to Ready Mode.

4.  (Scan to USB)

Press to scan to a USB flash drive.

5.  (Scan to PC)

Press to scan to the computer.

ADS-2700W

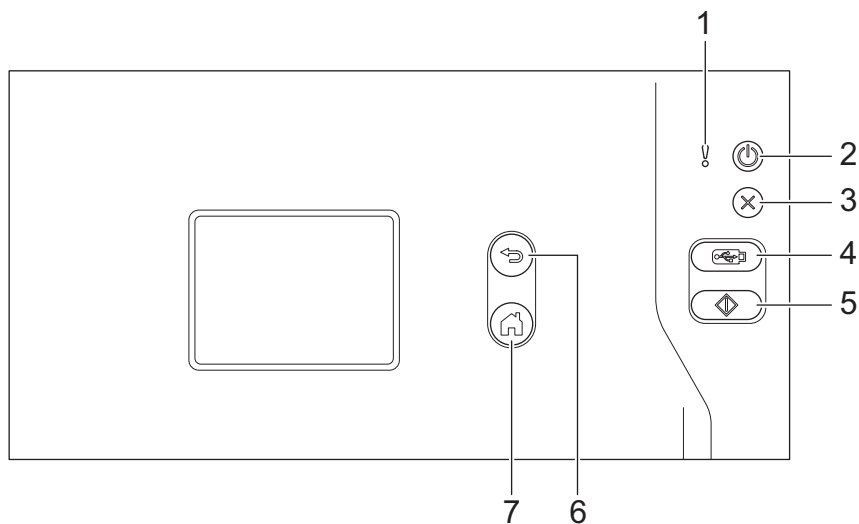

1. Error Indicator (with LED)

Blinks when the machine detects an error.

2. (Power On/Off) (with LED)

Press  to turn on the machine.

Press and hold  to turn off the machine. The touchscreen displays [Shutting Down] and stays on for a few seconds before turning off.

3. (Stop)

Press to stop or cancel your current action and return to Ready Mode.

4. (Scan to USB)

Press to scan to a USB flash drive.

5.

Press to execute the scan function assigned to the first shortcut.

6. (Back)

Press to go back to the previous screen or menu.

7. (Home Button)

Press to return to the Home Screen and Ready Mode.

8. Touchscreen LCD

Access the menus and options by pressing the touchscreen.



Related Information

- [Introduction to Your Brother Machine](#)
- [Add Shortcuts](#)

Touchscreen LCD Overview

Related Models: ADS-2700W

Home screen

There are two Home screens that you can access by pressing ◀ or ▶.

The following screens display the machine's status when the machine is idle:

Home Screen 1

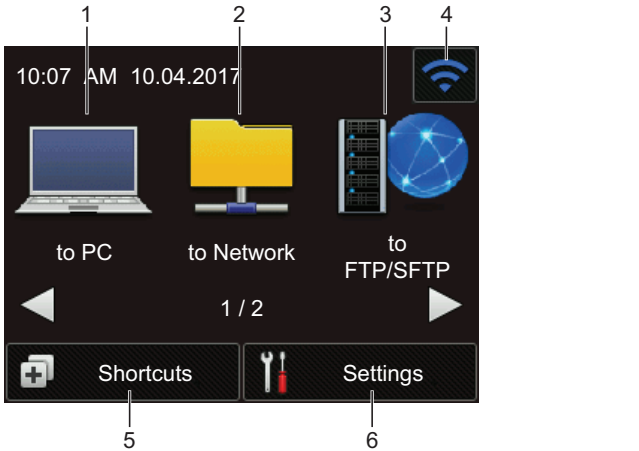
 <p>The screenshot shows Home Screen 1 with the following elements:<ul style="list-style-type: none">1: 'to PC' button with a laptop icon.2: 'to Network' button with a folder icon.3: 'to FTP/SFTP' button with a server rack icon.4: Wireless status icon in the top right corner.5: 'Shortcuts' button in the bottom left.6: 'Settings' button in the bottom right.The screen also displays the time '10:07 AM' and the date '10.04.2017' at the top left, and a '1 / 2' indicator at the bottom center.</p>	<p>Home Screen 1 provides access to Scan to PC, Scan to Network, and Scan to FTP/SFTP operations.</p>
--	---

Home Screen 2

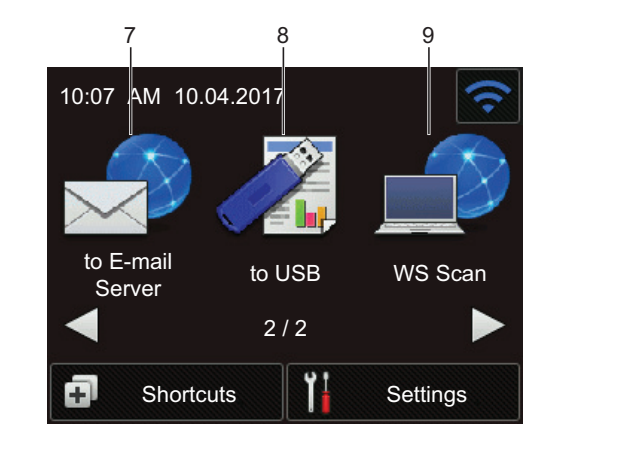
 <p>The screenshot shows Home Screen 2 with the following elements:<ul style="list-style-type: none">7: 'to E-mail Server' button with an envelope icon.8: 'to USB' button with a USB drive icon.9: 'WS Scan' button with a laptop icon.Wireless status icon in the top right corner.'Shortcuts' button in the bottom left.'Settings' button in the bottom right.The screen also displays the time '10:07 AM' and the date '10.04.2017' at the top left, and a '2 / 2' indicator at the bottom center.</p>	<p>Home Screen 2 provides access to Scan to E-mail Server, Scan to USB, and WS Scan operations.</p>
--	---

1. [to PC]
Press to access the Scan to PC function.
2. [to Network]
Press to access the Scan to Network function.
3. [to FTP/SFTP]
Press to access the Scan to FTP/SFTP function.

4.  (Wireless Status)

A four-level indicator on the Ready Mode screen displays the current wireless signal strength when using a wireless connection.

0	1	2	Max

You can configure wireless settings by pressing the Wireless Status button.

5. ([Shortcuts])

Press [Shortcuts] and then , to create Shortcuts for frequently-used operations such as Scan to PC, Scan to E-mail, Scan to USB, or other functions.

You can quickly scan using the options set as Shortcuts.

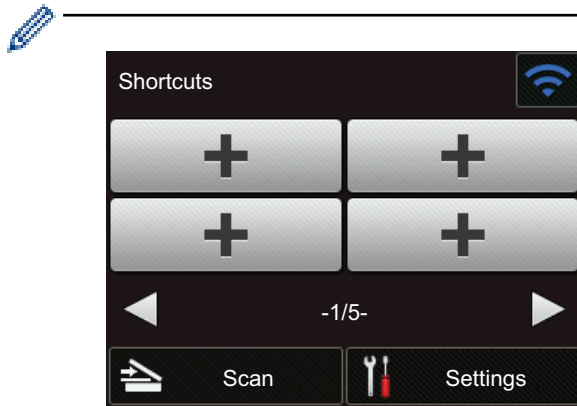

To display the other Shortcuts screens, press ◀ or ▶.

Five Shortcut screens are available with up to four Shortcuts on each tab. A total of 20 Shortcuts can be created.

6. ([Settings])

Press to access the Settings menu.

7. [to Email Server]

Press to access the Scan to E-mail Server function.

8. [to USB]

Press to access the Scan to USB function.

9. [WS Scan]

Press to access the WS Scan function.

-
- The warning icon appears when there is an error or maintenance message; press to return to Ready Mode.
 - This product adopts the font of ARPHIC TECHNOLOGY CO., LTD.

Settings Menu

Press ([Settings]) to check and access all the machine's settings.

- [General Setup]

Press to access the Settings menu.

- [Shortcut Settings]

Press to set Shortcuts. This option is unavailable and cannot be selected if you have not added Shortcuts.

- [Network]

Press to access Network settings.

- [Machine Info.]

Press to check the machine's information.

- [Initial Setup]

Press to access the [Date & Time], [Reset], and [Local Language] menus.



Related Information

- [Introduction to Your Brother Machine](#)
-

Paper Handling

- [Document Specifications](#)
- [Load Documents](#)

Document Specifications

- [Acceptable Documents](#)
- [Unacceptable Documents](#)
- [Carrier Sheet Recommendations](#)
- [Notes for Using Carrier Sheets](#)

Acceptable Documents

Do not load documents of varying page thickness or paper quality at the same time.

Standard Paper

Width	2 in. to 8.5 in. (51 mm to 215.9 mm)	
Length	2 in. to 14.0 in. (51 mm to 355.6 mm)	
Weight	0.11 lb to 0.46 lb (50 g/m ² to 209 g/m ²)	
Thickness	3.15 mil to 10.63 mil (0.06 mm to 0.26 mm) To scan thinner documents, use the Carrier Sheet (not included).	
Maximum Number of Pages	Up to 50 pages	
Standard Paper Size	A4	8.3 in. x 11.7 in. (210 mm x 297 mm)
	A5	5.8 in. x 8.3 in. (148 mm x 210 mm)
	A6	4.1 in. x 5.8 in. (105 mm x 148 mm)
	B5	7.2 in. x 10.1 in. (182 mm x 257 mm)
	B6	5 in. x 7.2 in. (128 mm x 182 mm)
	Legal	8.5 in. x 14 in. (215.9 mm x 355.6 mm)
	Mexican Legal	8.5 in. x 13.38 in. (215.9 mm x 339.9 mm)
	India Legal	8.46 in. x 13.58 in. (215 mm x 345 mm)
	Letter	8.5 in. x 11 in. (215.9 mm x 279.4 mm)
	Executive	7 1/4 in. x 10 1/2 in. (184.1 mm x 266.7 mm)
Folio	8 1/2 in. x 13 in. (215.9 mm x 330.2 mm)	

Plastic Card

Size (ISO)	3.37 in. x 2.13 in. (85.6 mm x 54 mm)
Material	Plastic (PET)
Type	Plastic card such as driver's license or store card
Thickness	Up to 52 mil (1.32 mm) (with embossing) Up to 43 mil (1.10 mm) (without embossing)
Maximum Number of Cards	One card



A plastic card can be scanned and saved to your computer as an image file. Configure the scanning application settings and then enable **Plastic Card Mode**.



Related Information

- [Document Specifications](#)

Unacceptable Documents

The following types of documents may not be scanned successfully:

- Documents with a carbon sheet attached
- Documents written in pencil
- Documents of uneven thickness, such as envelopes
- Documents with large wrinkles or curls
- Documents that use tracing paper
- Documents that use coated paper
- Photographs (photographic paper)
- Documents printed on perforated paper
- Documents printed on unusually-shaped paper (not square or rectangle)
- Documents with photos, notes, or stickers affixed to them
- Documents that use carbonless paper
- Documents that use loose-leaf paper or any paper with holes in it
- Documents with paper clips or staples
- Documents with wet ink
- Fabrics, metallic sheets, or overhead projector sheets
- Glossy or mirrored media
- Documents that exceed recommended thicknesses

IMPORTANT

- Carbonless papers contain chemical substances that may damage the rollers (for example, the Pick Up Roller). If paper jams occur frequently, clean the Brake Roller and Pick Up Roller. The life of the Brake Roller and Pick Up Roller may be reduced compared to scanning paper with high wood content.
- When scanning paper with high wood content, the life of the Brake Roller and Pick Up Roller may be reduced compared to scanning wood-free paper.
- The Brake Roller and Pick Up Roller may become damaged when a photo or sticky note on the document touches these parts during scanning.
- The surface of the document may be damaged when scanning glossy papers such as photographs.
- The damage caused by using any unacceptable documents with your Brother machine may not be covered under warranty.



Related Information

- [Document Specifications](#)
- [Area Not to be Perforated](#)
- [Scan a Mixed Batch](#)
- [Clean the Scanner and Rollers](#)

Area Not to be Perforated

An error may occur if your document has punched holes in the area shaded in light blue in the following figure:

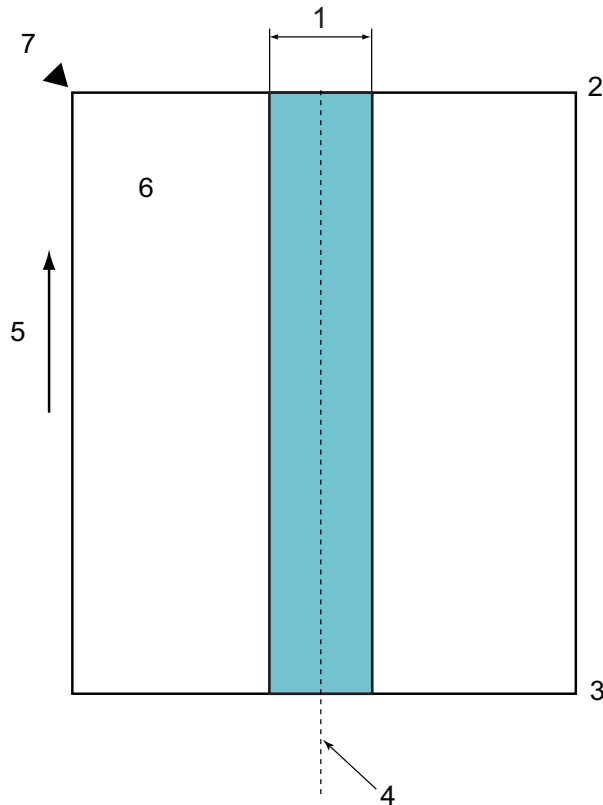

1. 1.77 in. (45 mm)
2. Top
3. Bottom
4. Center
5. Feed direction
6. Front side
7. Reference point



This condition applies when the document is set in the center of the Pick Up Roller.



Related Information

- [Unacceptable Documents](#)

Scan a Mixed Batch

The following conditions apply when scanning a mixed batch of documents with different paper weights, friction coefficients, or sizes. Make sure to test a few sheets first to check if the documents can be scanned.

Paper direction

Align the direction of the paper fiber with the feed direction.

Paper weight

Use the following paper weights: 0.11 lb to 0.46 lb (50 g/m² to 209 g/m²)

Friction coefficient

We recommend using the same type of paper from the same manufacturer. When papers of different manufacturers/brands are mixed, it affects the feeding performance as the difference in the friction coefficient increases.

We recommend using friction coefficients between 0.35 and 0.6 (reference value for paper friction coefficient).

Document position

Use paper sizes that fit the 1.77 in. (45 mm) width of the Pick Up Roller in the center.

Paper size

When you scan a mixed batch with different sizes, not feeding the documents straight may cause problems, such as paper jams or part of the image to appear missing.

We recommend checking the documents thoroughly before scanning and also checking the image if the document was skewed.



When scanning a mixed batch with different sizes, documents are more likely to skew while feeding because the Paper Guides do not touch every sheet.

Documents that cannot be scanned in a mixed batch

The following types of documents cannot be mixed in the same batch:

- Carbonless paper
- Bond paper
- Perforated documents
- Thermal paper
- Carbon-backed paper
- OHP film
- Tracing paper
- Synthetic paper
- Bent or damaged documents
- Thin paper (less than 40 g/m²)

How to scan a mixed batch

Load your document in the ADF in descending order of paper size with the largest at the back and the smallest at the front.



If you are loading a paper business card, load it horizontally.

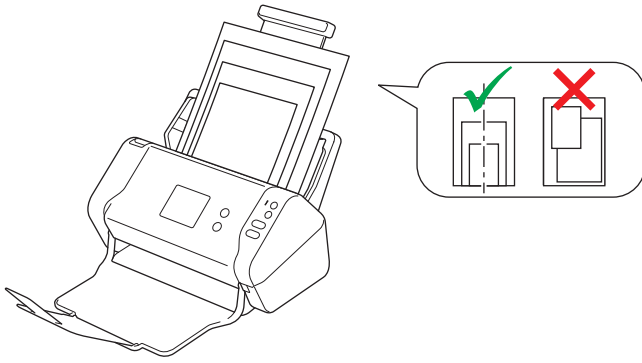

Related Information

- [Unacceptable Documents](#)
-

Carrier Sheet Recommendations

Brother recommends using a Carrier Sheet (not included) to scan the following documents:

- Documents with a carbon sheet attached
- Documents written in pencil
- Documents narrower than 2 in. (51 mm)
- Documents shorter than 2.76 in. (70 mm)
- Pages thinner than 3 mil (0.08 mm)
- Documents of uneven thickness, such as envelopes
- Documents with large wrinkles or curls
- Bent or damaged documents
- Documents that use tracing paper
- Documents that use coated paper
- Photographs (photographic paper)
- Documents printed on perforated paper
- Documents printed on unusually-shaped paper (not square or rectangle)
- Documents with photos, notes, or stickers attached to them
- Documents that use carbonless paper
- Documents that use loose-leaf paper or any paper with holes in it

CAUTION

To avoid cutting yourself, do not slide or scrape your hand or fingers along the edge of the Carrier Sheet.

IMPORTANT

- To avoid warping the Carrier Sheet, do not place the Carrier Sheet in direct sunlight or in an area subject to high temperatures and high humidity.
- To avoid damaging the Carrier Sheet, do not bend or pull it. Do not use a damaged Carrier Sheet, as it may produce incorrect scan results.

Related Information

- [Document Specifications](#)
- [Supplies](#)

Notes for Using Carrier Sheets

- To avoid document jams, do not load the Carrier Sheet (not included) upside down. See the instructions printed on the Carrier Sheet itself for more information.
- To avoid document jams, do not put several small documents into the Carrier Sheet at the same time. Insert only one document into the Carrier Sheet at a time.
- Do not write on the Carrier Sheet, as the writing may be seen in scanned documents. If the Carrier Sheet becomes dirty, wipe it with a dry cloth.
- Do not leave documents in the Carrier Sheet for extended periods of time; the printing on the documents may bleed through onto the Carrier Sheet.
- **If you use any of the Unacceptable Documents and damage your Brother machine, it may not be covered under warranty.**



Related Information

- [Document Specifications](#)
 - [Supplies](#)
-

Load Documents

The ADF can hold up to 50 pages and feeds each sheet individually. Use 20 lb (80 g/m²) paper and always fan the pages before placing them in the ADF.

IMPORTANT

- Make sure documents with ink or correction fluid are completely dry.
- DO NOT pull on the document while it is feeding.
- DO NOT use paper that is curled, wrinkled, folded, ripped, stapled, paper-clipped, pasted, or taped.
- DO NOT use cardboard or fabric.

-
- [Load Standard Size Documents](#)
 - [Load Business Cards](#)
 - [Load a Plastic Card](#)
 - [Load Documents Longer than Standard Size](#)
 - [Load Non-standard Size Documents](#)
 - [Load Receipts, Clippings, Photos, and Other Documents](#)

Load Standard Size Documents

1. Adjust the Paper Guides (1) to fit the width of your document.

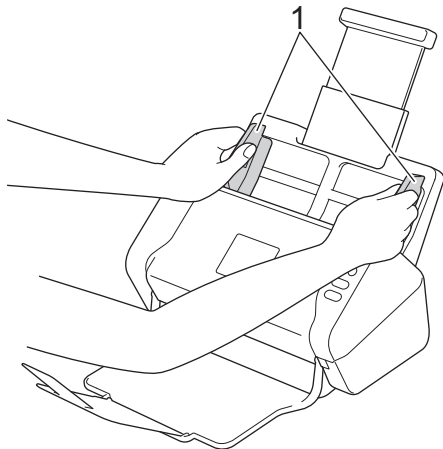

2. Fan the pages several times along both the long edge and the short edge.

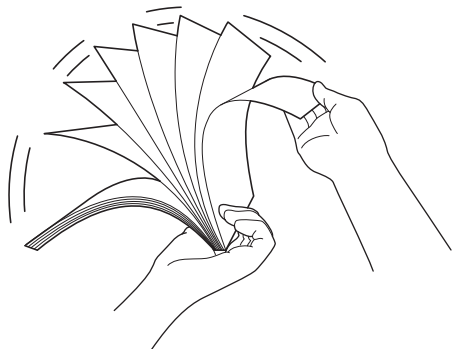

3. Align the edges of the pages.

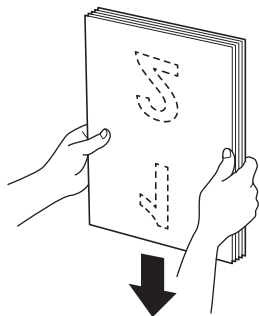

4. Place your document, *face down, top edge first* in the ADF between the Paper Guides until you feel it touch the inside of the machine. Feed thin pages slowly and carefully to keep the edge from being folded.

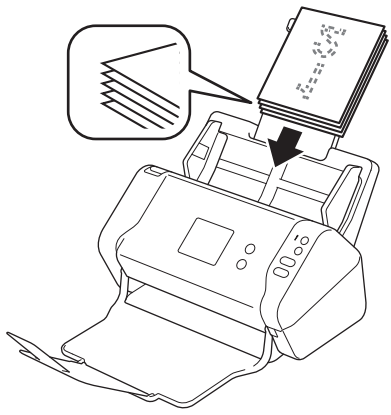

Related Information

- [Load Documents](#)

Load Business Cards

1. Adjust the Paper Guides (1) to fit the width of your document.

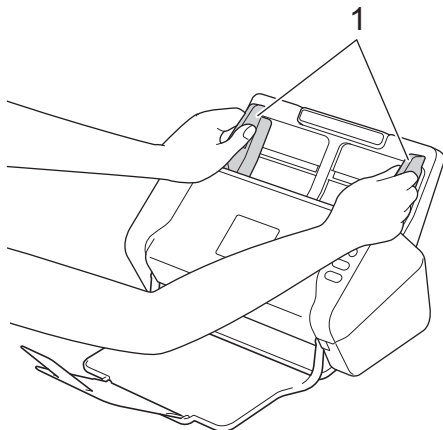

2. Place the card, *face down*, *top edge first* in the ADF between the Paper Guides until you feel it touch the inside of the machine.

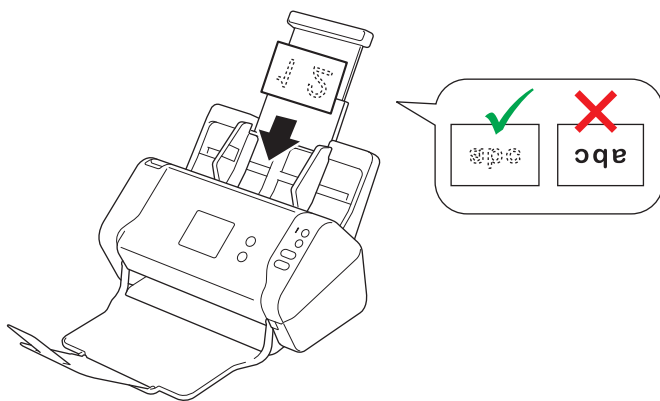

You can load up to 25 business cards (total thickness less than 0.2 in. (5 mm) at a time).



Related Information

- [Load Documents](#)

Load a Plastic Card

1. Adjust the Paper Guides (1) to fit the width of your document.

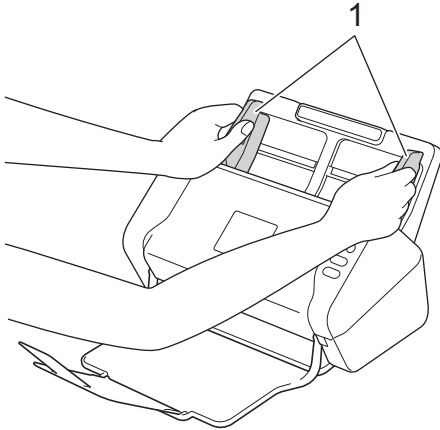

2. Place the card, *face down*, *top edge first* in the ADF between the Paper Guides until you feel it touch the inside of the machine.

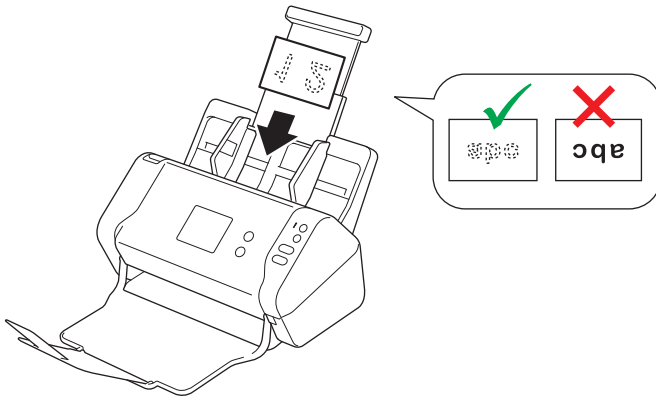

- Load only one plastic card at a time.
- Certain types of plastic cards may be scratched when scanned.
- Rigid cards may not be fed correctly.
- If the surface of the card is dirty with grease marks (for example, fingerprints) or similar, wipe the dirt off before scanning.



Related Information

- [Load Documents](#)

Load Documents Longer than Standard Size

Make sure documents with ink or correction fluid are completely dry.

1. Adjust the Paper Guides (1) to fit the width of your document.

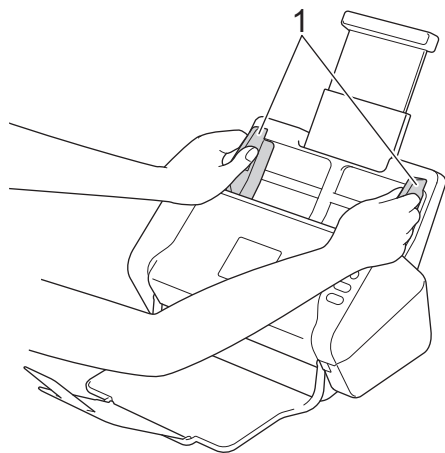

2. Place your document, *face down, top edge first* in the ADF between the Paper Guides until you feel it touch the inside of the machine.

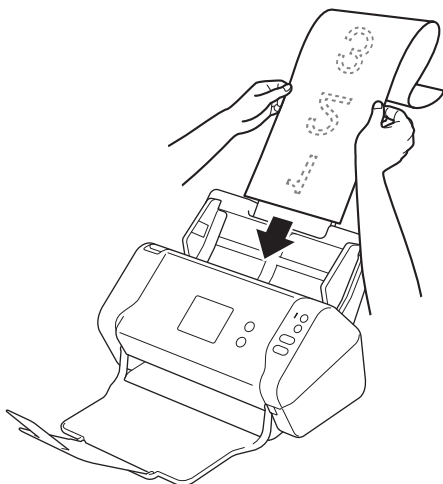

- Load only one document at a time.
- Support the document with your hand if the document is longer than the extended ADF.



Related Information

- [Load Documents](#)

Load Non-standard Size Documents

Make sure documents with ink or correction fluid are completely dry.

1. Fold your document in half and insert it into the Carrier Sheet (not included).

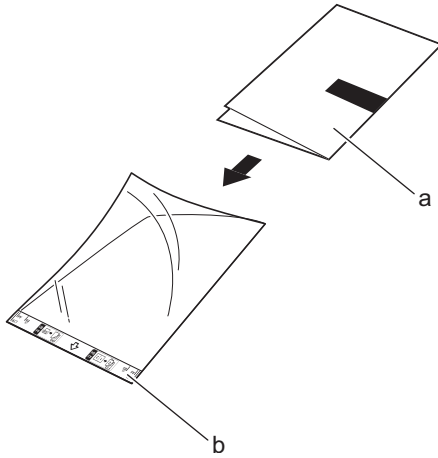

- a. Document is Face Down
- b. Carrier Sheet Header is Face Up



Set the Paper document in the center of the Carrier Sheet and align the top of the document with the top of the Carrier Sheet.

2. Adjust the Paper Guides (1) to fit the width of the Carrier Sheet.

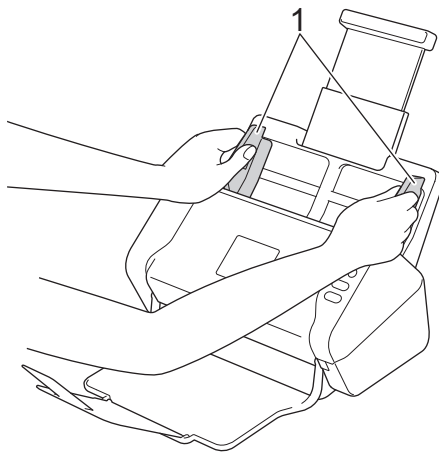

3. Place the Carrier Sheet, *face down* in the ADF between the Paper Guides until you feel it touch the inside of the machine.

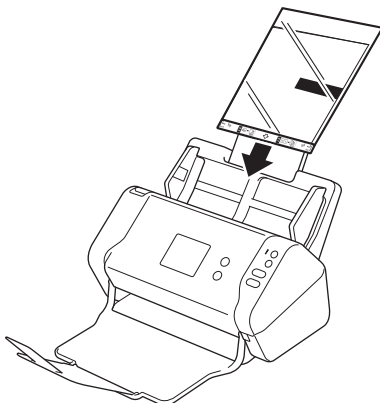



To reduce the white space in the center of a scanned page, position the folded edge of the original document close to the edge of the Carrier Sheet.



Related Information

- [Load Documents](#)
-

Load Receipts, Clippings, Photos, and Other Documents

Make sure documents with ink or correction fluid are completely dry.

1. Insert the document into the Carrier Sheet (not included).

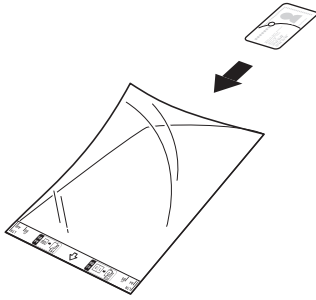

- Set the Paper document in the center of the Carrier Sheet and align the top of the document with the top of the Carrier Sheet.
- If the receipt is longer than the Carrier Sheet, you can fold the receipt in two places so that it overlaps when you insert it into the Carrier Sheet.

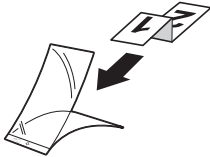

2. Adjust the Paper Guides (1) to fit the width of the Carrier Sheet.

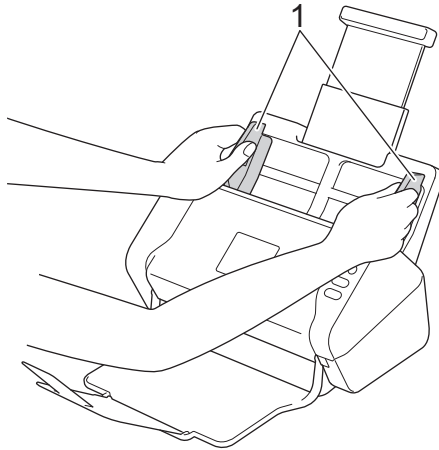

3. Place the Carrier Sheet, *face down* in the ADF between the Paper Guides until you feel it touch the inside of the machine.

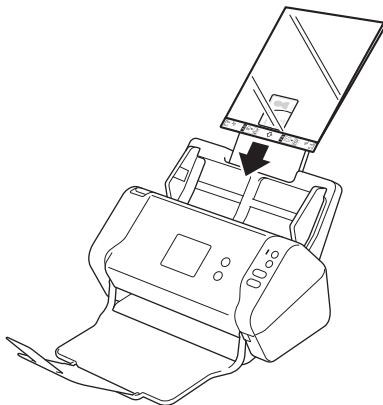



Related Information

- [Load Documents](#)
-

Scan

- [Before Scanning](#)
- [Scan Using the Scan Button on Your Brother Machine](#)
- [Scan from Your Computer \(Windows®\)](#)
- [Scan from Your Computer \(Mac\)](#)

Before Scanning

Before scanning, confirm the following:

- Make sure you have installed the scanner driver by following the steps in the *Quick Setup Guide*.
- If your Brother machine is connected via a network cable or USB cable, make sure the interface cable is physically secure.

Scan Using the Scan Button on Your Brother Machine

- [Save Scanned Documents on Your Computer](#)
- [Save Scanned Documents to a USB Flash Drive](#)
- [Send Scanned Data to an Email Server](#)
- [Set Up the Address Book](#)
- [Scan to FTP](#)
- [Scan to SFTP](#)
- [Scan to Network](#)
- [Web Services for Scanning on Your Network \(Windows® 7, Windows® 8 and Windows® 10\)](#)
- [Scan Options Using the Touchscreen](#)
- [Restrict Scan Functions from External Devices](#)

Save Scanned Documents on Your Computer

- >> ADS-2200
- >> ADS-2700W

ADS-2200





To change scan settings, such as resolution, file size or scan type, follow the steps below.

- Do one of the following:
 - Windows®
Click (Start) > All Programs > Brother > ADS-XXXXX > Remote Setup.
 - Mac
In the **Finder** menu bar, click **Go** > **Applications** > **Brother**, and then double-click the **Remote Setup** icon.
- Select your model name in the Discover Devices dialog box, and then click **Connect**.
The Remote Setup Program window appears.
- Select **Scan to PC** in the navigation tree, and then configure scan settings as needed.

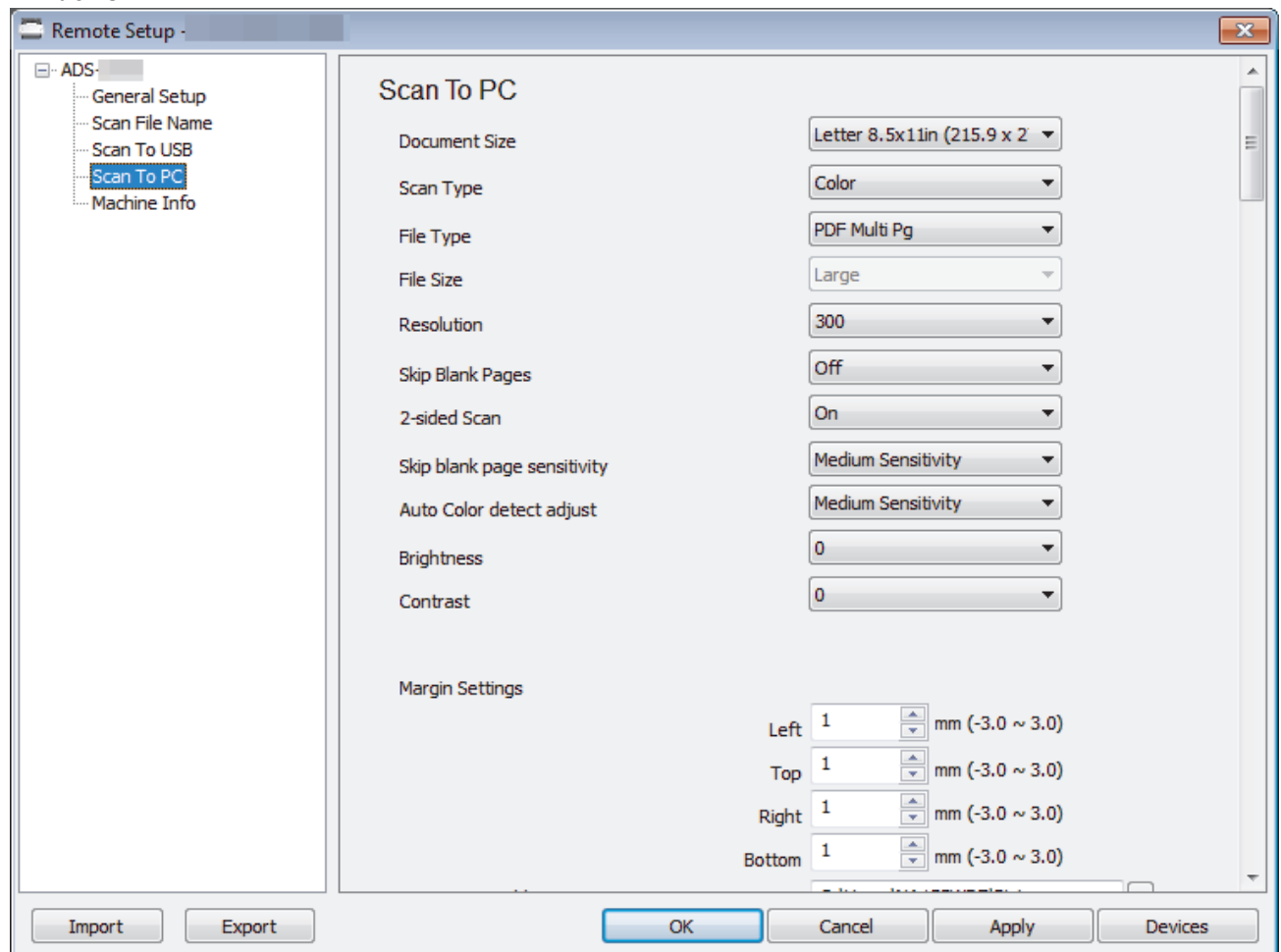
Windows®

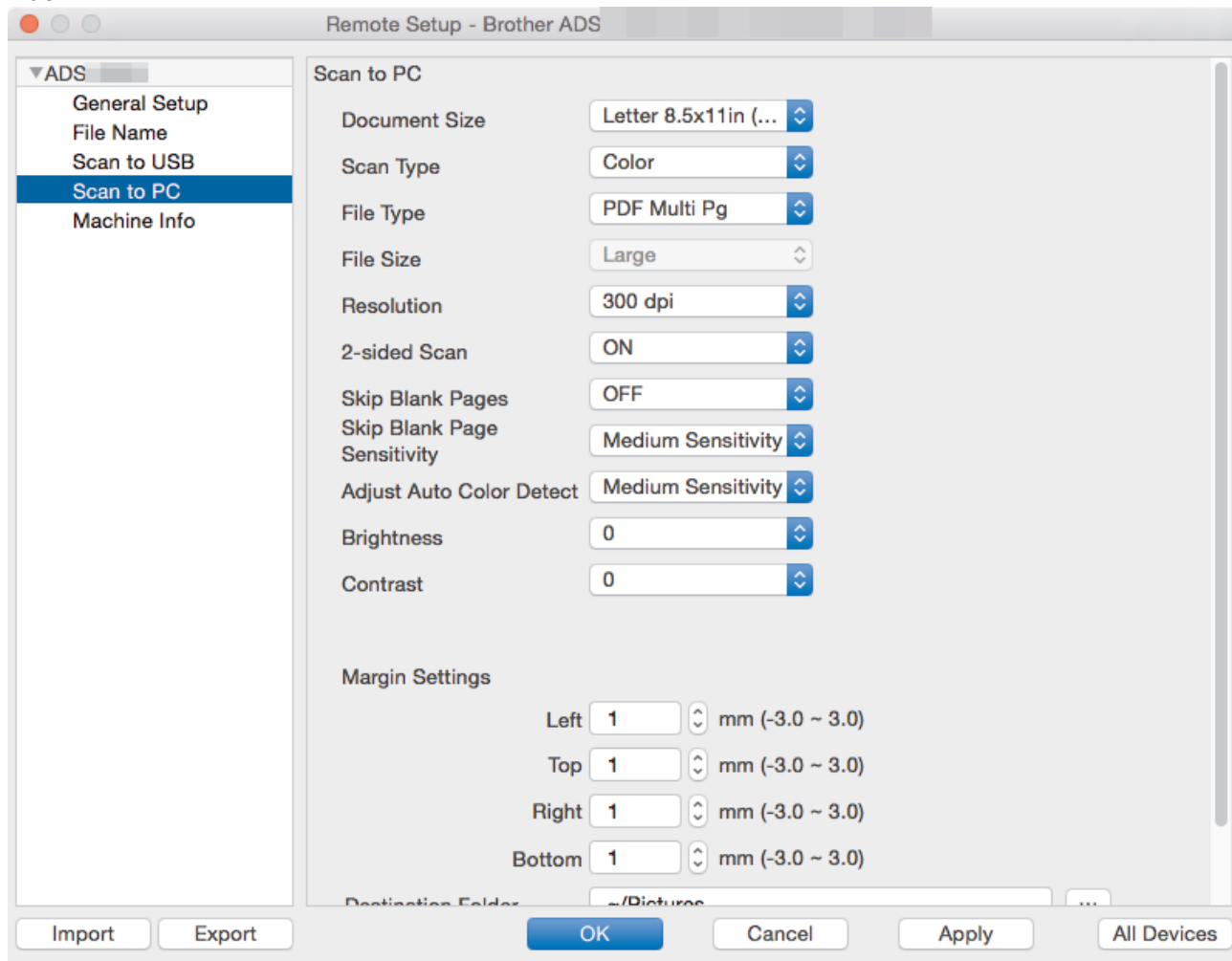



4. Click **OK** to close the Remote Setup window.
5. Load your document.
6. Press  (Scan to PC) on the control panel.

The machine starts scanning.



When a USB flash drive is inserted in your machine, scanning from a computer is disabled. To scan from your computer, remove the USB flash drive.

ADS-2700W



- To change scan settings, such as resolution, file size or scan type, follow the steps below.
- This procedure explains how to change the settings each time you scan documents. To use the same settings every time, change the settings using Remote Setup.

1. Load your document.
2. Press ◀ or ▶ to display [to PC], and press it.
3. If multiple computers are connected to the machine, press ▲ or ▼ to display the destination computer you want to save on, and press it.
4. To change the scan settings, press [Options]. Configure the following settings, and then press [OK]:
 - [2-sided Scan]
 - [Scan Type]
 - [Resolution]
 - [File Type]

-
- [Document Size]
 - [Skip Blank Page]
 - [Advanced Settings]



-
- To configure other settings, press [Advanced Settings].
 - To save the settings as a shortcut, press [Save as Shortcut].
 - If signed PDF was selected from the [File Type] drop-down list, you must configure the certificate settings using Web Based Management.
-

5. Press [Start].

The machine starts scanning.



When a USB flash drive is inserted in your machine, scanning from a computer is disabled. To scan from your computer, remove the USB flash drive.



Related Information

- [Scan Using the Scan Button on Your Brother Machine](#)
-

Save Scanned Documents to a USB Flash Drive

To avoid damaging the drive or the data stored on the USB flash drive, DO NOT remove it while the machine is scanning to it.



When a USB flash drive is inserted in your machine, scanning from a computer is disabled. To scan from your computer, remove the USB flash drive.

>> [ADS-2200](#)

>> [ADS-2700W](#)

ADS-2200



To change scan settings, such as resolution, file size or scan type, follow the steps below.

1. Do one of the following:
 - Windows®
Click  (Start) > **All Programs** > **Brother** > **ADS-XXXXX** > **Remote Setup**.
 - Mac
In the **Finder** menu bar, click **Go** > **Applications** > **Brother**, and then double-click the **Remote Setup** icon.
2. Select your model name in the Discover Devices dialog box, and then click **Connect**.
The Remote Setup Program window appears.
3. Select **Scan to USB** in the navigation tree, and then configure scan settings as needed.

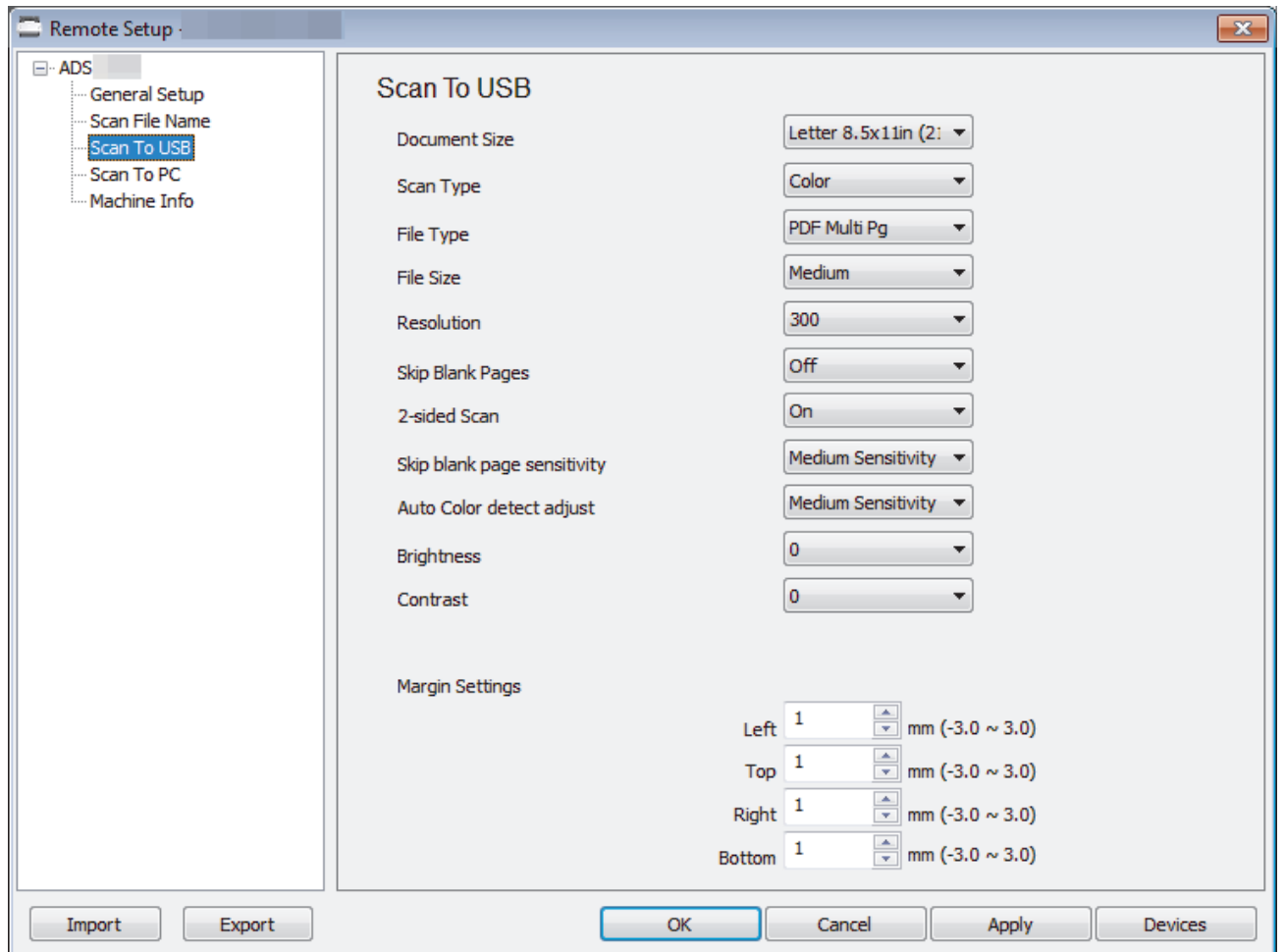

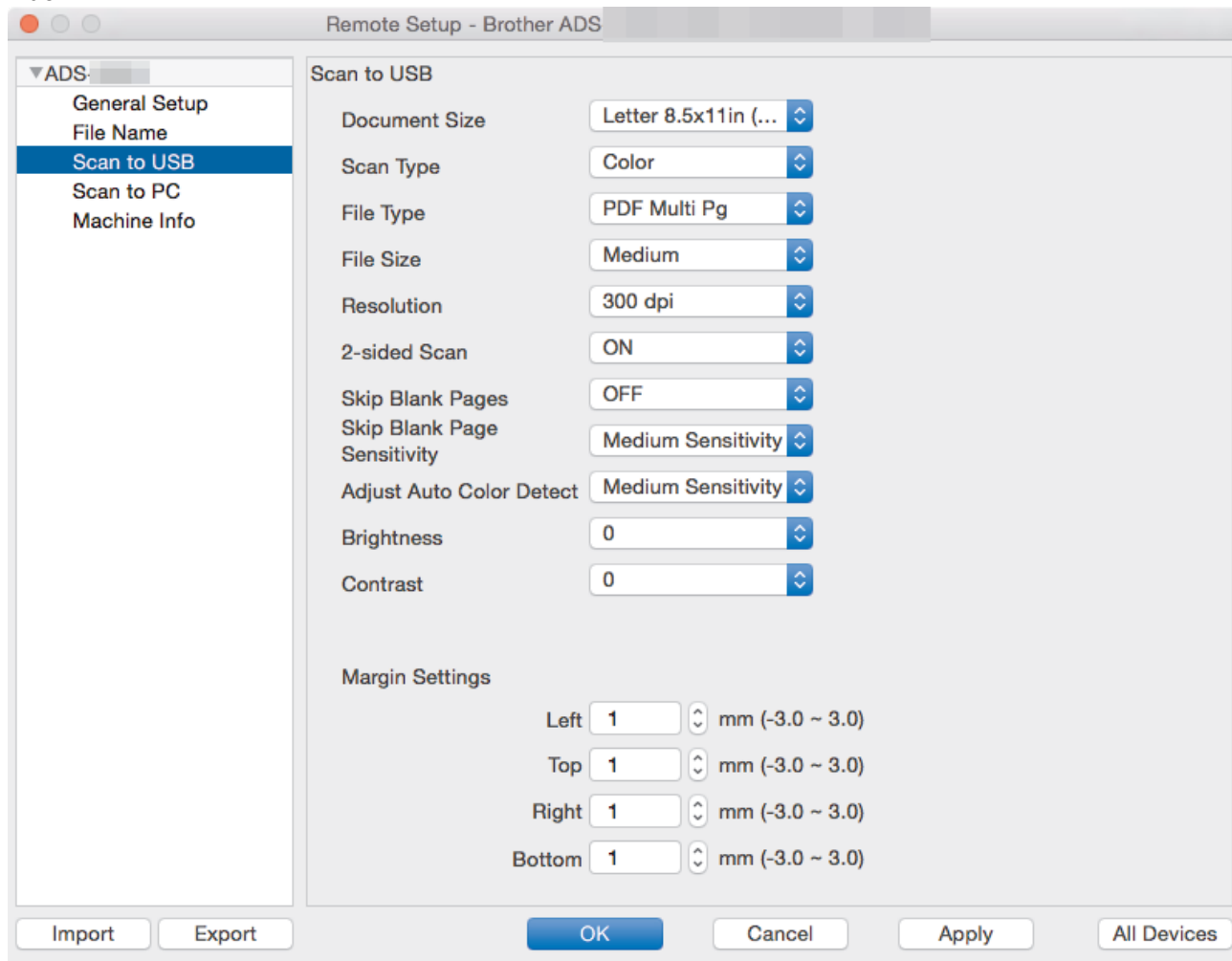

4. Click **OK** to close the Remote Setup window.
5. Insert a USB flash drive into the machine.
6. Load your document.
7. Press  (Scan to USB) on the control panel.

The machine starts scanning, and then the scanned data is saved on the USB flash drive.

ADS-2700W



- To change scan settings, such as resolution, file size or scan type, follow the steps below.
- This procedure explains how to change the settings each time you scan documents. To use the same settings every time, change the settings using Remote Setup.

1. Load your document.
2. Insert a USB flash drive into the machine.
The Scan to USB screen appears automatically. If the Scan to USB screen does not appear, press [to USB] in the Home screen.
3. To change the scan settings, press [Options]. Configure the following settings, and then press [OK]:
 - [2-sided Scan]
 - [Scan Type]
 - [Resolution]
 - [File Type]
 - [Document Size]
 - [Skip Blank Page]

-
- [Advanced Settings]
 - [Set New Default]
 - [Factory Reset]



-
- To configure other settings, press [Advanced Settings].
 - To save the settings as a shortcut, press [Save as Shortcut].
 - To select [Long Paper (Narrow)] or [Long Paper (Normal)] for [Document Size], use the following settings: [Scan Type]: [Color] or [Black and White].
 - If signed PDF was selected from the [File Type] drop-down list, you must configure the certificate settings using Web Based Management.

4. Press [Start].

The machine starts scanning, and then the scanned data is saved on the USB flash drive.



Related Information

- [Scan Using the Scan Button on Your Brother Machine](#)
-

Send Scanned Data to an Email Server

Related Models: ADS-2700W

Before using this feature, you must first configure your E-mail Server settings using Web Based Management. See *Related Information: Send an Email Securely*

1. Load your document.
2. Press ◀ or ▶ to display [to Email Server], and press it.
3. Do one of the following to enter the destination email address:
 - To select an email address from the Address Book, do the following:
 - a. Press [Address Book].
 - b. Press ▲ or ▼ until you find the name you are looking for.
 - c. Press the name from the result.
 - d. Press [OK].
4. Press [OK].
5. To change the scan settings, press [Options]. Configure the following settings, and then press [OK]:
 - [2-sided Scan]
 - [Scan Type]
 - [Resolution]
 - [File Type]
 - [Document Size]
 - [Skip Blank Page]
 - [Advanced Settings]

 - To configure other settings, press [Advanced Settings].
 - To save the settings as a shortcut, press [Save as Shortcut].
 - If signed PDF was selected from the [File Type] drop-down list, you must configure the certificate settings using Web Based Management.

6. Press [Start].

The machine starts scanning, and then sends the scanned document to the email address directly.

✓ Related Information

- [Scan Using the Scan Button on Your Brother Machine](#)
- [Use TX Verification Mail](#)
- [Send an Email Securely](#)

Use TX Verification Mail

Related Models: ADS-2700W

Use TX Verification Mail to request notification from the destination computer that your email was received and processed. Use Web Based Management to turn on the verification feature. When **Request Delivery Notification** is **On**, your email contains an additional field that is automatically populated with the email's arrival date and time.

1. Start your web browser.
2. Type "http://machine's IP address" in your browser's address bar (where "machine's IP address" is the machine's IP address).

For example:

http://192.168.1.2

3. By default, no password is required. If you have previously set a password, type it, and then click .
4. Click the **E-mail** tab.
5. Click **E-mail Send**.
6. In the **Request Delivery Notification** field, click **On**.
7. Click **Submit**.



- Message Disposition Notification (MDN)

This field requests the status of the email message after delivery through the Simple Mail Transfer Protocol (SMTP) transport system. After the recipient has received the message, this data is used when the machine or user reads the received email. For example, if the message is opened and read, the receiver sends back a notification to the original sending machine or user.

The recipient must activate the MDN field to be able to send a notification report; otherwise the request will be ignored.

- This Brother machine cannot receive email messages. To use the TX Verification feature, you must redirect the return notification to a different email address. Configure the email address using Web Based Management. Access Web Based Management, click the **E-mail** tab, click **SMTP** and confirm **Device E-mail Address**. Enter the email address that you want to receive the notification.



Related Information

- [Send Scanned Data to an Email Server](#)

Set Up the Address Book

Related Models: ADS-2700W

The Address Book feature lets you select an email address to send the scanned data directly.



Configure the Address Book using Remote Setup or Web Based Management.



Related Information

- [Scan Using the Scan Button on Your Brother Machine](#)
- [Register an Email Address Using Remote Setup](#)
- [Register an Email Address Using Web Based Management](#)

Register an Email Address Using Remote Setup

Related Models: ADS-2700W

You can register up to 300 email addresses and enter a name for each address.

1. Do one of the following:
 - Windows®
Click  (**Start**) > **All Programs** > **Brother** > **ADS-XXXXX** > **Remote Setup**.
 - Mac
In the **Finder** menu bar, click **Go** > **Applications** > **Brother**, and then double-click the **Remote Setup** icon.
2. Select your model name in the Discover Devices dialog box, and then click **Connect**.
The Remote Setup Program window appears.
3. Select **Address Book** in the navigation tree.
4. Click **+** in the **Contact** area .
5. Enter a name and an email address.
6. Click **Create**.
7. Click **OK**.



To create a group, click **+** in the **Group** area and then configure settings as needed.



Related Information

- [Set Up the Address Book](#)
- [Access Web Based Management](#)

Register an Email Address Using Web Based Management

Related Models: ADS-2700W

You can register up to 300 email addresses and enter a name for each address.

1. Start your web browser.

Type "http://machine's IP address" in your browser's address bar (where "machine's IP address" is the machine's IP address). For example: http://192.168.1.2

By default, no password is required. If you have previously set a password, type it, and then click .

2. Click the **Address Book** tab.
3. In the **E-mail Address** field, type an email address.
4. In the **Name** field, type a name.
5. Click **Submit**.

Related Information

- [Set Up the Address Book](#)

Scan to FTP

Related Models: ADS-2700W

Scan documents directly to an FTP server when you need to share the scanned information. For added convenience, configure different profiles to save your favorite Scan to FTP destinations.



Related Information

- [Scan Using the Scan Button on Your Brother Machine](#)
- [Set up a Scan to FTP Profile](#)
- [Upload Scanned Data to an FTP Server](#)

Set up a Scan to FTP Profile

Related Models: ADS-2700W

Set up a Scan to FTP Profile to scan and upload the scanned data directly to an FTP location.

We recommend Microsoft® Internet Explorer® 8/10/11 for Windows®, and Safari 8.0 for Mac. Make sure that JavaScript and Cookies are always enabled in whichever browser you use. If a different web browser is used, make sure it is compatible with HTTP 1.0 and HTTP 1.1.

1. Start your web browser.

Type "http://machine's IP address" in your browser's address bar (where "machine's IP address" is the machine's IP address). For example: http://192.168.1.2

By default, no password is required. If you have previously set a password, type it, and then click .

2. Click the **Scan** tab.
3. Click the **Scan to FTP/SFTP/Network** menu in the left navigation bar.
4. Select the **FTP** option, and then click **Submit**.
5. Click the **Scan to FTP/SFTP/Network Profile** menu in the left navigation bar.
6. Select the profile you want to set up or change.

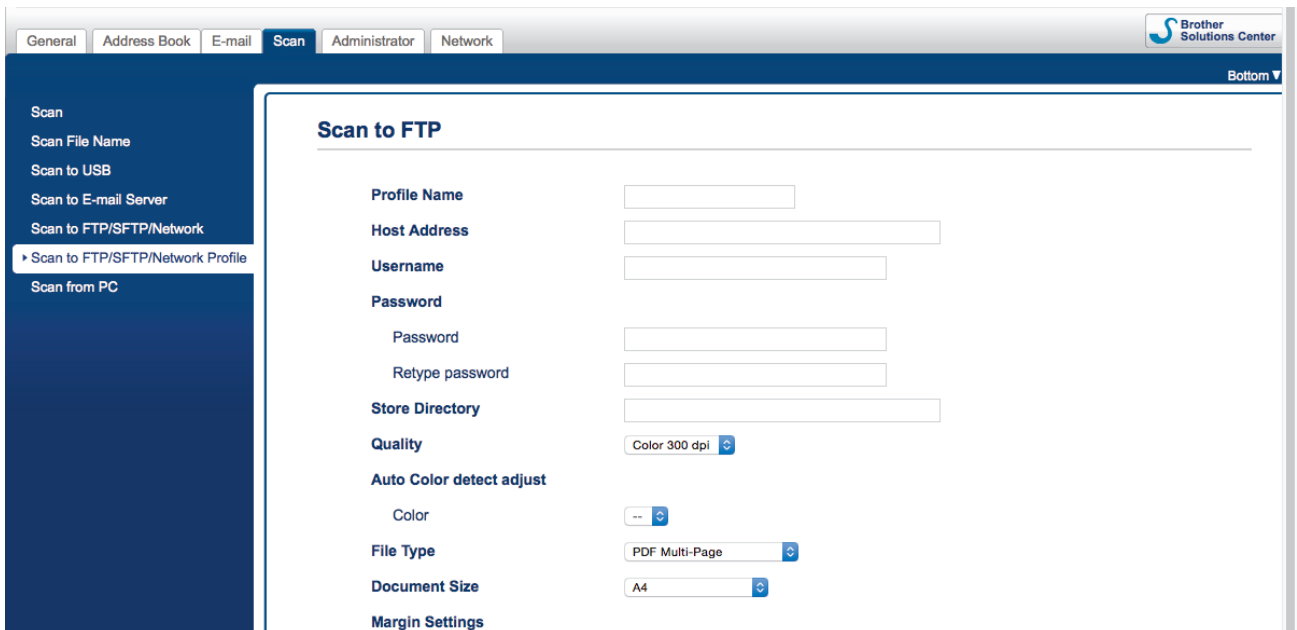

The Profile setting screen appears.

7. In the **Profile Name** field, type a name for this server profile (up to 14 alphanumeric characters).
The machine will display this name on the LCD.
8. In the **Host Address** field, type the Host Address (for example: ftp.example.com; up to 64 characters) or the IP address (for example: 192.23.56.189), and type the path (up to 255 characters) to the folder on the FTP server where you want to send your scanned data. Do not type a slash symbol at the beginning of the path.
9. In the **Username** field, type a user name (up to 32 characters) that has permission to write data to the FTP server.
10. In the **Password** field, type the password (up to 33 characters) associated with the user name you entered in the **Username** field. Type the password again in the **Retype password** field.
11. In the **Store Directory** field, type the path (up to 255 characters) to the folder on the FTP server where you want to send your scanned data. Do not type a slash symbol at the beginning of the path.
12. Click the **Quality** drop-down list, and then select a quality setting. When **Auto** is selected, you can adjust the detection level of color from the **Auto Color detect adjust** drop-down list.

-
13. Click the **File Type** drop-down list, and then select the file type you want to use for the scanned document.
 14. Click the **Document Size** drop-down list, and then select your document size from the list. This is necessary to make sure the scanned file is the correct size.
 15. In the **Margin Settings**, enter a value between -3 and 3 to add or remove a specific margin at the edge of the image.
 16. Click the **File Size** drop-down list, and then select your file size from the list.
 17. Select **On** from the **Skip Blank Page** option, to remove blank pages of the document from the scanning results.
 18. Click the **Skip blank page sensitivity** drop-down list, and then select a value between -5 and 5.
 19. Click the **2-sided Scan** drop-down list.
 20. Click the **Brightness** drop-down list, and then select the brightness level.
 21. Click the **Contrast** drop-down list, and then select the contrast level.
 22. Select **On** from the **Continuous Scan** option to continue scanning.
 23. Set the **Passive Mode** option to off or on depending on your FTP server and network firewall configuration. The default setting is on. In most cases, this setting does not need to be changed.
 24. Change the **Port Number** setting used to access the FTP server. The default for this setting is port 21. In most cases, this setting does not need to be changed.
 25. Click **Submit**.



-
- You can set the scanned file name and file name style in the **Scan File Name** menu in the left navigation bar.
 - Using the following characters: ?, /, \, ", :, <, >, |, or * may cause a sending error.
-



Related Information

- [Scan to FTP](#)
-

Upload Scanned Data to an FTP Server

Related Models: ADS-2700W

1. Load your document.
2. Press ◀ or ▶ to display [to FTP/SFTP], and press it.
3. Press ▲ or ▼ to select one of the FTP server profiles listed.
4. If the Scan to FTP profile is not complete, press [Options]. Configure the following settings, and then press [OK]:
 - [2-sided Scan]
 - [Scan Type]
 - [Resolution]
 - [File Type]
 - [Document Size]
 - [File Size]
 - [Skip Blank Page]
 - [Advanced Settings]



- To configure other settings, press [Advanced Settings].
- To save the settings as a shortcut, press [Save as Shortcut].
- If signed PDF was selected from the [File Type] drop-down list, you must configure the certificate settings using Web Based Management.

5. Press [Start].

The LCD displays the message [Connecting]. When the connection to the FTP server is successful, the machine starts scanning.



Related Information

- [Scan to FTP](#)

Scan to SFTP

Related Models: ADS-2700W

Scan documents directly to an SFTP server when you need to share the scanned information. For added convenience, configure different profiles to save your favorite Scan to SFTP destinations.



Related Information

- [Scan Using the Scan Button on Your Brother Machine](#)
 - [Set up a Scan to SFTP Profile](#)
 - [Upload Scanned Data to an SFTP Server](#)
-

Set up a Scan to SFTP Profile

Related Models: ADS-2700W

Set up a Scan to SFTP Profile to scan and upload the scanned data directly to an SFTP location.

We recommend Microsoft® Internet Explorer® 8/10/11 for Windows®, and Safari 8.0 for Mac. Make sure that JavaScript and Cookies are always enabled in whichever browser you use. If a different web browser is used, make sure it is compatible with HTTP 1.0 and HTTP 1.1.

1. Start your web browser.

Type "http://machine's IP address" in your browser's address bar (where "machine's IP address" is the machine's IP address). For example: http://192.168.1.2

By default, no password is required. If you have previously set a password, type it, and then click .

2. Click the **Scan** tab.
3. Click the **Scan to FTP/SFTP/Network** menu in the left navigation bar.
4. Select the **SFTP** option, and then click **Submit**.
5. Click the **Scan to FTP/SFTP/Network Profile** menu in the left navigation bar.
6. Select the profile you want to set up or change.

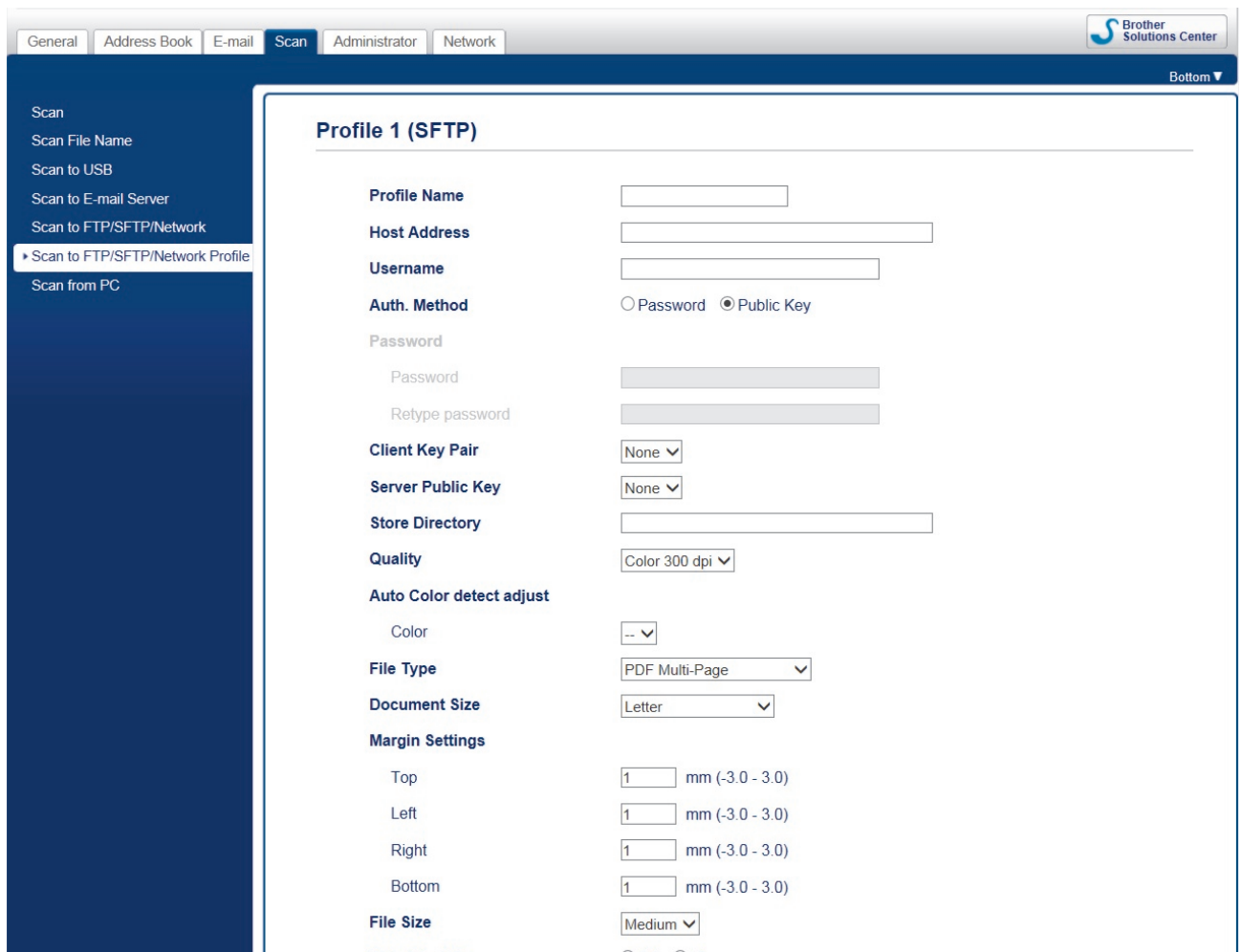

The Profile setting screen appears.

7. In the **Profile Name** field, type a name for this server profile (up to 14 alphanumeric characters).
The machine will display this name on the LCD.

-
8. In the **Host Address** field, type the Host Address (for example: sftp.example.com; up to 64 characters) or the IP address (for example: 192.23.56.189), and type the path (up to 60 characters) to the folder on the SFTP server where you want to send your scanned data. Do not type a slash symbol at the beginning of the path.
 9. In the **Username** field, type a user name (up to 32 characters) that has permission to write data to the SFTP server.
 10. In the **Auth. Method** field, select **Password** or **Public Key**.
 11. Do one of the following:
 - If you have selected **Password**, type the password (up to 32 characters) associated with the user name you typed in the **Username** field. Type the password again in the **Retype password** field.
 - If you have selected **Public Key**, select the authentication type from the **Client Key Pair** drop-down list.
 12. Select the authentication type from the **Server Public Key** drop-down list.
 13. In the **Store Directory** field, type the path (up to 60 characters) to the folder on the SFTP server where you want to send your scanned data. Do not type a slash symbol at the beginning of the path.
 14. Click the **Quality** drop-down list, and then select a quality setting. When **Auto** is selected, you can adjust the detection level of color from the **Auto Color detect adjust** drop-down list.
 15. Click the **File Type** drop-down list, and then select the file type you want to use for the scanned document.
 16. Click the **Document Size** drop-down list, and then select your document size from the list. This is necessary to make sure the scanned file is the correct size.
 17. In the **Margin Settings**, enter a value between -3 and 3 to add or remove a specific margin at the edge of the image.
 18. Click the **File Size** drop-down list, and then select your file size from the list.
 19. Select **On** from the **Skip Blank Page** option, to remove blank pages of the document from the scanning results.
 20. Click the **Skip blank page sensitivity** drop-down list, and then select a value between -5 and 5.
 21. Click the **2-sided Scan** drop-down list.
 22. Click the **Brightness** drop-down list, and then select the brightness level.
 23. Click the **Contrast** drop-down list, and then select the contrast level.
 24. Select **On** from the **Continuous Scan** option to continue scanning.
 25. Change the **Port Number** setting used to access the SFTP server. The default for this setting is port 21. In most cases, this setting does not need to be changed.
 26. Click **Submit**.



-
- You can set the scanned file name and file name style in the **Scan File Name** menu in the left navigation bar.
 - Using the following characters: ?, /, \, ", :, <, >, |, or * may cause a sending error.
 - You can use Web Based Management to create, import, and export a client key pair.
-



Related Information

- [Scan to SFTP](#)
 - [Access Web Based Management](#)
-

Upload Scanned Data to an SFTP Server

Related Models: ADS-2700W

1. Load your document.
2. Press ◀ or ▶ to display [to FTP/SFTP], and press it.
3. Press ▲ or ▼ to select one of the SFTP server profiles listed.
4. If the Scan to SFTP profile is not complete, press [Options]. Configure the following settings, and then press [OK]:
 - [2-sided Scan]
 - [Scan Type]
 - [Resolution]
 - [File Type]
 - [Document Size]
 - [File Size]
 - [Skip Blank Page]
 - [Advanced Settings]



- To configure other settings, press [Advanced Settings].
- To save the settings as a shortcut, press [Save as Shortcut].
- If signed PDF was selected from the [File Type] drop-down list, you must configure the certificate settings using Web Based Management.

5. Press [Start].

The LCD displays the message [Connecting]. When the connection to the SFTP server is successful, the machine starts scanning.



Related Information

- [Scan to SFTP](#)

Scan to Network

- [Set up a Scan to Network Profile](#)
- [Upload Scanned Data to a Mapped Network Drive \(CIFS\) Server](#)

Set up a Scan to Network Profile

Related Models: ADS-2700W

Set up a Scan to Network Profile to scan and upload scanned data directly to a folder on a Mapped Network Drive (CIFS) server.

We recommend Microsoft® Internet Explorer® 8/10/11 for Windows®, and Safari 8.0 for Mac. Make sure that JavaScript and Cookies are always enabled in whichever browser you use. If a different web browser is used, make sure it is compatible with HTTP 1.0 and HTTP 1.1.

1. Start your web browser.

Type "http://machine's IP address" in your browser's address bar (where "machine's IP address" is the machine's IP address). For example: http://192.168.1.2

By default, no password is required. If you have previously set a password, type it, and then click .

2. Click the **Scan** tab.
3. Click the **Scan to FTP/SFTP/Network** menu in the left navigation bar.
4. Select the **Network** option, and then click **Submit**.
5. Click the **Scan to FTP/SFTP/Network Profile** menu in the left navigation bar.
6. Select the profile you want to set up or change.

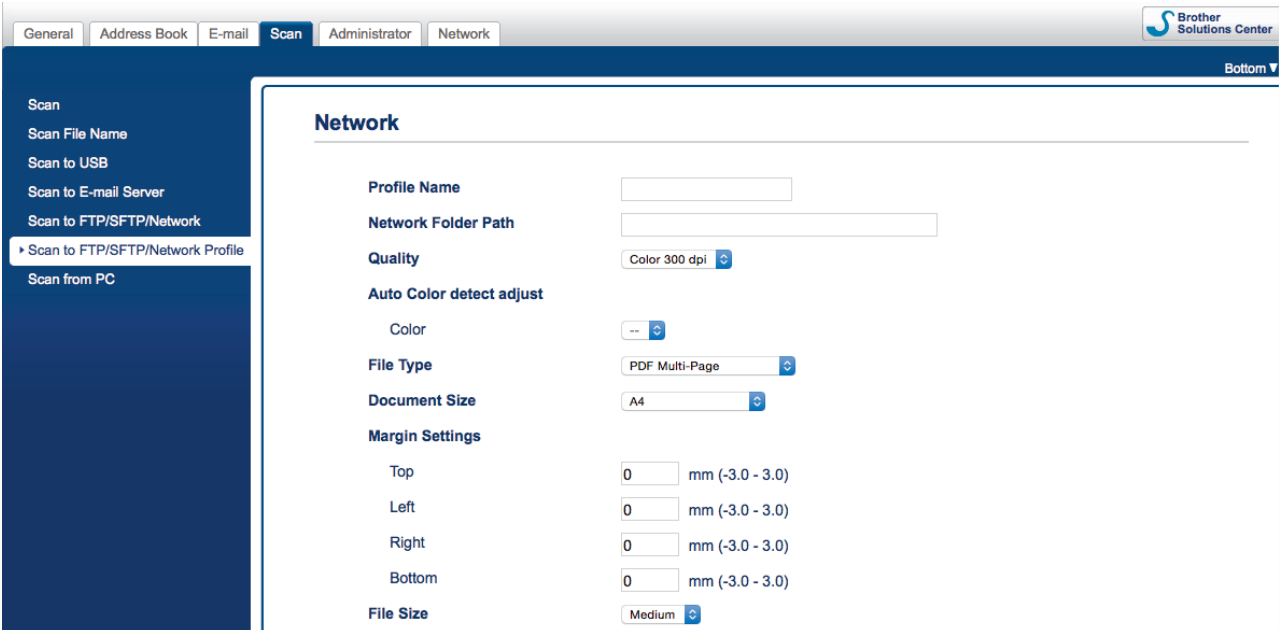

The screenshot shows the Brother Solutions Center web interface. The top navigation bar includes tabs for General, Address Book, E-mail, Scan, Administrator, and Network. The left sidebar contains a 'Scan' menu with options: Scan File Name, Scan to USB, Scan to E-mail Server, Scan to FTP/SFTP/Network, Scan to FTP/SFTP/Network Profile (highlighted), and Scan from PC. The main content area is titled 'Network' and contains the following settings:

- Profile Name:
- Network Folder Path:
- Quality: Color 300 dpi
- Auto Color detect adjust: --
- Color: --
- File Type: PDF Multi-Page
- Document Size: A4
- Margin Settings:
 - Top: 0 mm (-3.0 - 3.0)
 - Left: 0 mm (-3.0 - 3.0)
 - Right: 0 mm (-3.0 - 3.0)
 - Bottom: 0 mm (-3.0 - 3.0)
- File Size: Medium

The Profile setting screen appears.

7. In the **Profile Name** field, type a name for this server profile (up to 14 alphanumeric characters).
The machine will display this name on the LCD.
8. In the **Network Folder Path** field, type the path to the folder on the Mapped Network Drive (CIFS) server where you want to send your scanned data.
9. Click the **Quality** drop-down list, and then select a quality setting. When **Auto** is selected, you can adjust the detection level of color from the **Auto Color detect adjust** drop-down list.
10. Click the **File Type** drop-down list, and then select the file type you want to use for the scanned document.
11. Click the **Document Size** drop-down list, and then select your document size from the list. This is necessary to make sure the scanned file is the correct size.
12. In the **Margin Settings**, enter a value between -3 and 3 to add or remove a specific margin at the edge of the image.

-
13. Click the **File Size** drop-down list, and then select your file size from the list.
 14. Select **On** from the **Skip Blank Page** option, to remove blank pages of the document from the scanning results.
 15. Click the **Skip blank page sensitivity** drop-down list, and then select a value between -5 and 5.
 16. Click the **2-sided Scan** drop-down list.
 17. Click the **Brightness** drop-down list, and then select the brightness level.
 18. Click the **Contrast** drop-down list, and then select the contrast level.
 19. Select **On** from the **Continuous Scan** option to continue scanning.
 20. In the **Username** field, type a user name (up to 96 characters) that has permission to write data to the folder specified in the **Network Folder Path** field. If the user name is part of a domain, type the user name in one of the following styles:
user@domain
domain\user
 21. In the **Password** field, type the password (up to 33 characters) associated with the user name you entered in the **Username** field. Type the password again in the **Retype password** field.
 22. Click **Submit**.
 23. You must configure the SNTP (network time server) or you must set the date, time and time zone correctly on the control panel.



-
- You can set the scanned file name and file name style in the **Scan File Name** menu in the left navigation bar.
 - Using the following characters: ?, /, \, ", :, <, >, |, or * may cause a sending error.
-



Related Information

- [Scan to Network](#)
-

Upload Scanned Data to a Mapped Network Drive (CIFS) Server

Related Models: ADS-2700W

1. Load your document.
2. Press ◀ or ▶ to display [to Network], and press it.
3. Press ▲ or ▼ to select one of the Network server profiles listed.
4. If the Scan to Network profile is not complete, press [Options]. Configure the following settings, and then press [OK]:
 - [2-sided Scan]
 - [Scan Type]
 - [Resolution]
 - [File Type]
 - [Document Size]
 - [File Size]
 - [Skip Blank Page]
 - [Advanced Settings]



- To configure other settings, press [Advanced Settings].
- To save the settings as a shortcut, press [Save as Shortcut].
- If signed PDF was selected from the [File Type] drop-down list, you must configure the certificate settings using Web Based Management.

5. Press [Start].

The LCD displays the message [Connecting]. When the connection to the Network server is successful, the machine starts scanning.



Related Information

- [Scan to Network](#)

Web Services for Scanning on Your Network (Windows® 7, Windows® 8 and Windows® 10)

The Web Services protocol enables Windows® 7, Windows® 8 and Windows® 10 users to scan using a Brother machine on the network. You must install the driver via Web Services.

- [Use Web Services to Install Drivers Used for Scanning \(Windows® 7, Windows® 8 and Windows® 10\)](#)
- [Scan Using Web Services from the Brother Machine \(Windows® 7, Windows® 8 and Windows® 10\)](#)
- [Configure Scan Settings for Web Services](#)

Use Web Services to Install Drivers Used for Scanning (Windows® 7, Windows® 8 and Windows® 10)

Related Models: ADS-2700W

Use Web Services to monitor scanners on the network.

- Make sure you have installed the Brother software and drivers.
- Verify that the host computer and the Brother machine are on the same subnet, or that the router is correctly configured to pass data between the two devices.
- You must configure the IP address on your Brother machine before you configure this setting.

1. Do one of the following:

- Windows® 10

Click  > **Windows System** > **Control Panel**. In the **Hardware and Sound** group, click **Add a device**.

- Windows® 8.1

Move your mouse to the lower right corner of your desktop. When the menu bar appears, click **Settings** > **Change PC settings** > **PC and devices** > **Devices** > **Add a device**.

The machine's Web Services Name appears.

- Windows® 8

Move your mouse to the lower right corner of your desktop. When the menu bar appears, click **Settings** > **Change PC settings** > **Devices** > **Add a device**.

The machine's Web Services Name appears.

- Windows® 7

Click  (**Start**) > **Control Panel** > **Network and Internet** > **View network computers and devices**.

The machine's Web Services Name appears with the scanner icon.

Right-click the machine you want to install.



- The Web Services Name for the Brother machine is your model name and the MAC Address (Ethernet Address) of your machine (for example, Brother ADS-XXXXX (model name) [XXXXXXXXXXXX] (MAC Address / Ethernet Address)).

- Windows® 8/Windows® 10

Move your mouse over the machine name to display the machine's information.

2. Do one of the following:

- Windows® 8/Windows® 10

Select the machine you want to install, and then follow the on-screen instructions.

- Windows® 7

Click **Install** in the displayed menu.



To uninstall drivers, click **Uninstall** or  (**Remove device**).



Related Information

- [Web Services for Scanning on Your Network \(Windows® 7, Windows® 8 and Windows® 10\)](#)

Scan Using Web Services from the Brother Machine (Windows® 7, Windows® 8 and Windows® 10)

Related Models: ADS-2700W

If you have installed the driver for scanning via Web Services, you can access the Web Services scanning menu on your Brother machine's LCD.

Certain characters in the messages displayed on the LCD may be replaced with spaces if the language settings of your OS and your Brother machine are different.

1. Load your document.
2. Press ◀ or ▶ to display [WS Scan], and press it.
3. Press the type of scan you want to perform.
4. Press ▲ or ▼ to display the computer name where you want to send the data, and then press the computer name.
5. Press [Start].

The machine starts scanning.



Related Information

- [Web Services for Scanning on Your Network \(Windows® 7, Windows® 8 and Windows® 10\)](#)

Configure Scan Settings for Web Services

Related Models: ADS-2700W

1. Do one of the following:

- Windows® 10

Click  > **Windows System** > **Control Panel**. In the **Hardware and Sound** group, click **View devices and printers**.

- Windows® 8

Move your mouse to the lower right corner of your desktop. When the menu bar appears, click **Settings**, and then click **Control Panel**. In the **Hardware and Sound** group, click **View devices and printers**.

- Windows® 7

Click  (**Start**) > **Devices and Printers**.

2. Right-click the machine icon, and then select **Scan profiles....**

The **Scan profiles...** dialog box appears.

3. Select the scan profile you want to use.

4. Make sure the scanner selected in the **Scanner** list is a Brother machine that supports Web Services for scanning, and then click the **Set as Default** button.

5. Click **Edit...**

The **Edit Default Profile** dialog box appears.

6. Select the **Source**, **Paper size**, **Color format**, **File type**, **Resolution (DPI)**, **Brightness** and **Contrast** settings.

7. Click the **Save Profile** button.

These settings will be applied when you scan using the Web Services protocol.

If you are requested to select a scanning application, select Windows® Fax and Scan or Windows® Photo Gallery from the list.



Related Information

- [Web Services for Scanning on Your Network \(Windows® 7, Windows® 8 and Windows® 10\)](#)

Scan Options Using the Touchscreen

Related Models: ADS-2700W

To change scan settings, press [Options].

Option	Description
2-sided Scan	When using 2-sided scanning, select 2-sided Scan: Long Edge so the layout of the data file's pages matches your original.
Scan Type	Select the scan type for your document. When Auto is selected, the machine automatically detects whether the document uses color and generates a scanned image of the document. For documents that mix color and black and white pages, color pages are scanned in the Color mode, and black and white pages are scanned in the Black and White mode.
Resolution	Select a scanning resolution. Higher resolutions produce a finer scanned image but consume more memory and increase transfer time.
File Type	Select the file type you want to use for the scanned data.
Document Size	Select the exact size of your document.
File Size	Select Small , Medium , or Large for the file size.
Skip Blank Page	When On is selected, blank pages are skipped. Use the slider to adjust the sensitivity level for detecting blank pages in the scanned data. The higher the sensitivity, the easier it is for the machine to detect blank pages.
Advanced Settings	Continuous Scan Scan more pages than the maximum capacity of the ADF and save them as one data file. After scanning the first batch of documents, press Continue to scan additional pages. When you are finished scanning, press Complete .
	Color Tone Adjustment Adjust the brightness and contrast.
	Adjust Auto Color Detect When the Scan Type is set to Auto , you can adjust the detection level of color.
	Skip Blank Page sensitivity Select the sensitivity level for detecting blank pages in the scanned data. The higher the sensitivity, the easier it is for the machine to detect blank pages.
	Margin Settings Adjust the scanning position of documents if the output position of the images has shifted or if the images are squeezed together or stretched vertically.
Set New Default	Returns the settings to the default settings.
Factory Reset	Returns the settings to the factory settings.



Related Information

- [Scan Using the Scan Button on Your Brother Machine](#)

Restrict Scan Functions from External Devices

Related Models: ADS-2700W

This feature allows you to restrict scan functions from external devices. When you restrict scan functions from external devices, an error message appears on the device and users cannot use those scan functions.

We recommend Microsoft® Internet Explorer® 8/10/11 for Windows®, and Safari 8.0 for Mac. Make sure that JavaScript and Cookies are always enabled in whichever browser you use. If a different web browser is used, make sure it is compatible with HTTP 1.0 and HTTP 1.1.

1. Start your web browser.

Type "http://machine's IP address" in your browser's address bar (where "machine's IP address" is the machine's IP address). For example: http://192.168.1.2

By default, no password is required. If you have previously set a password, type it, and then click .

2. Click the **Scan** tab.
3. Click the **Scan from PC** menu in the left navigation bar.
4. Disable the **Pull Scan** option.
5. Click **Submit**.



Related Information

- [Scan Using the Scan Button on Your Brother Machine](#)

Scan from Your Computer (Windows®)

There are several ways you can use your computer to scan documents on your Brother machine. Use the software applications provided by Brother, or use your favorite scanning application.

- [Scan Using Nuance™ PaperPort™ 14 or Other Windows® Applications](#)
- [Scan Using Windows® Photo Gallery or Windows® Fax and Scan](#)



Scan Using Nuance™ PaperPort™ 14 or Other Windows® Applications

You can use the Nuance™ PaperPort™ 14 application, which is included in the scanner driver, for scanning.

For detailed instructions on using each application, click the application's **Help** menu, and then click **Getting Started Guide** in the **Help** ribbon.



The instructions for scanning in these steps are for Nuance™ PaperPort™ 14. For other Windows® applications, the steps will be similar. Nuance™ PaperPort™ 14 supports both TWAIN and WIA drivers; the TWAIN driver (recommended) is used in these steps.

1. Load your document.
2. Start Nuance™ PaperPort™ 14. Do one of the following:
 - Windows® XP and Windows® 7
Click  (**Start**) > **All Programs** > **Nuance PaperPort 14** > **PaperPort**.
 - Windows® 8
Click  (**PaperPort**).
 - Windows® 10
Click  > **All apps** > **Nuance PaperPort 14** > **PaperPort**.
3. Click the **Desktop** menu, and then click **Scan Settings** in the **Desktop** ribbon.
The **Scan or Get Photo** panel appears on the left side of the screen.
4. Click **Select**.
5. From the available Scanners list, select **TWAIN: Brother ADS-XXXXX** or **TWAIN: Brother ADS-XXXXX LAN** (where ADS-XXXXX is the model name of your machine). To use the WIA driver, select the Brother driver that has "WIA" as the prefix.
6. Select the **Display scanner dialog box** check box in the **Scan or Get Photo** panel.
7. Click **Scan**.
The Scanner Setup dialog box appears.

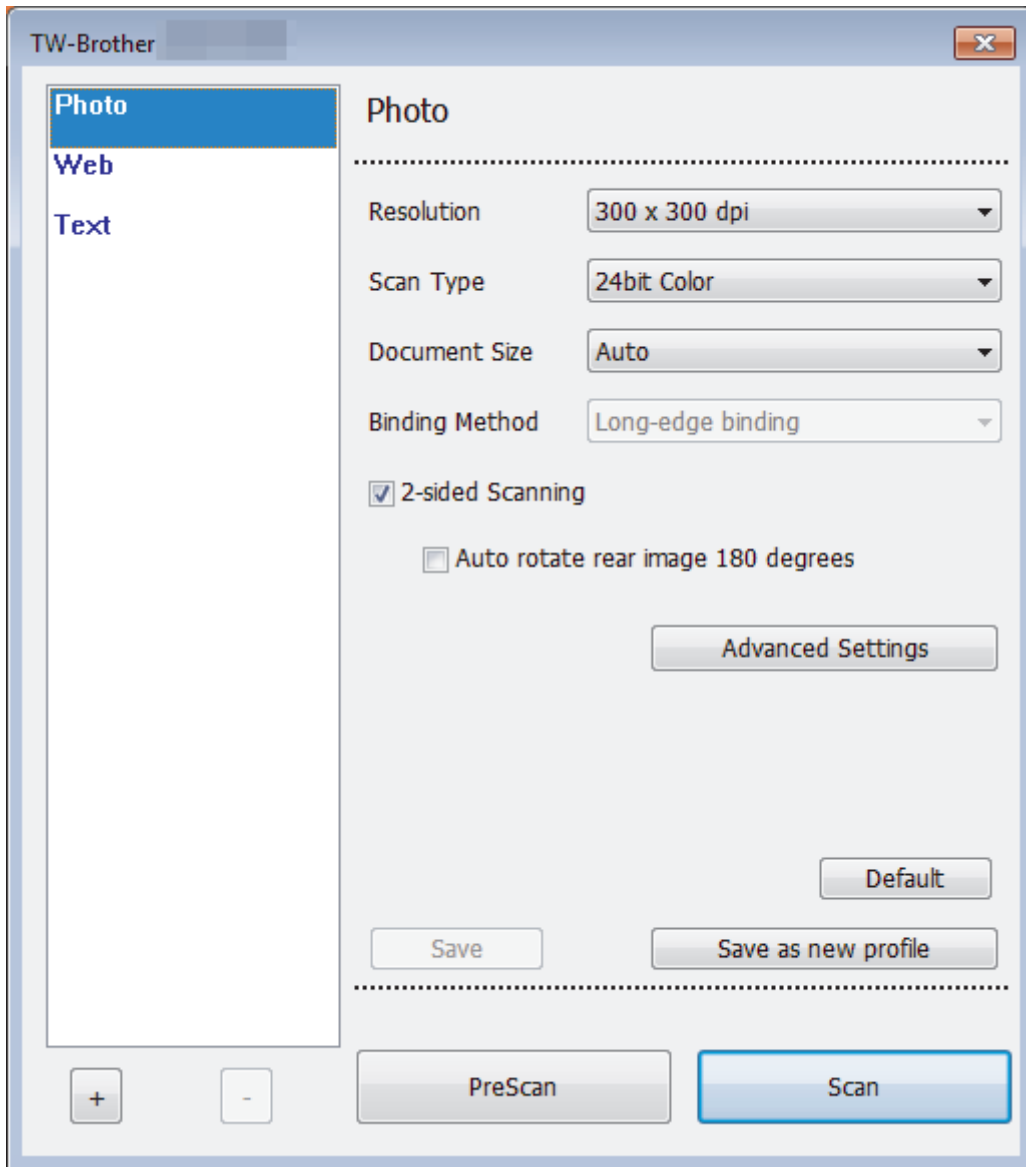

8. Adjust the settings in the Scanner Setup dialog box, if needed.
9. Click the **Document Size** drop-down list, and then select your document size.
10. Click **PreScan** to preview your image and crop unwanted portions before scanning.
11. Click **Scan**.

The machine starts scanning.

✓ Related Information

- [Scan from Your Computer \(Windows®\)](#)
- [TWAIN Driver Settings \(Windows®\)](#)

TWAIN Driver Settings (Windows®)

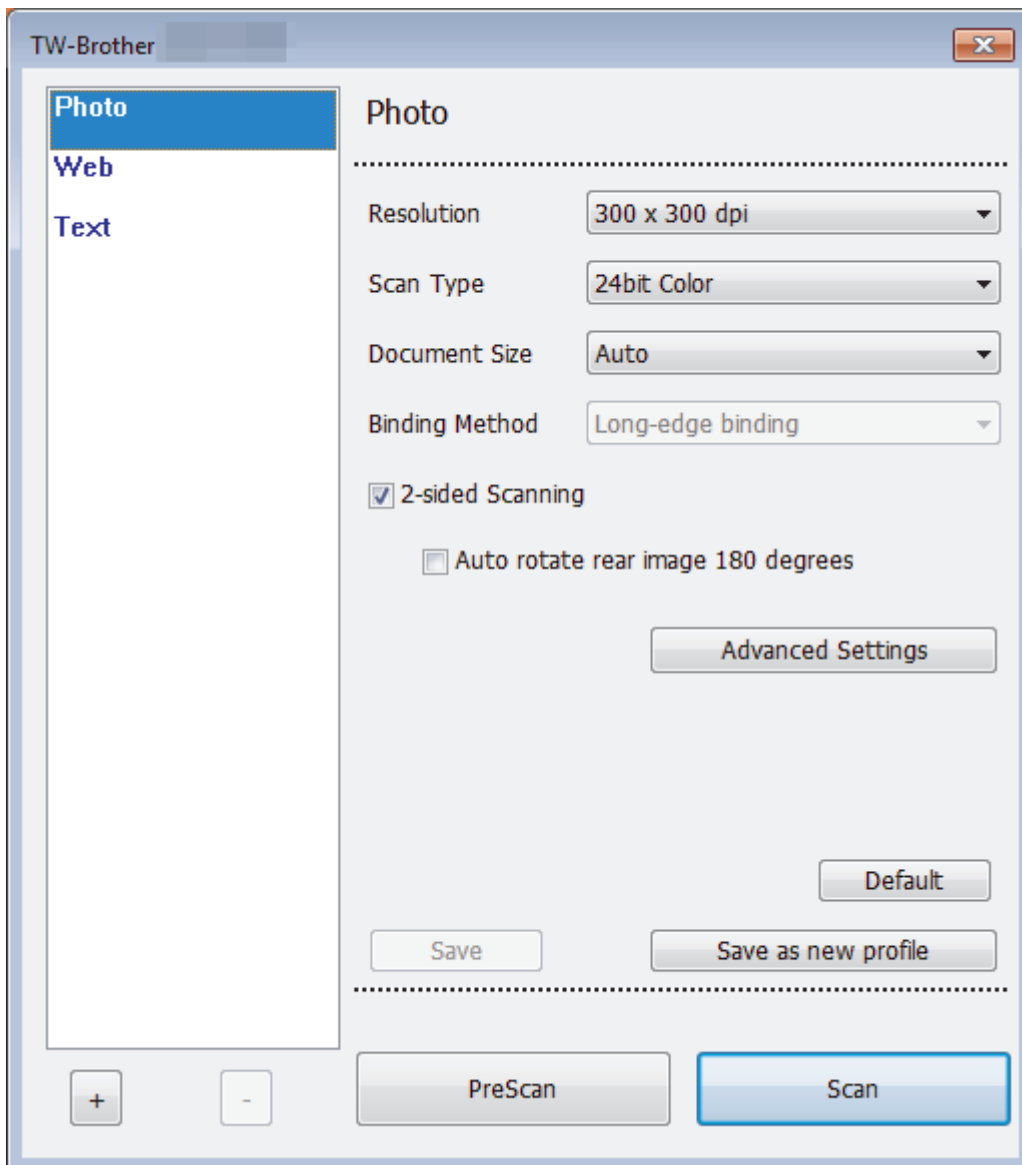

- Note that the item names and assignable values will vary depending on the machine.
- Load only one document per scanning sequence when **Long paper**, **Carrier Sheet Mode**, or **Plastic Card Mode** is selected.

1. Scan

Select the **Photo**, **Web**, or **Text** option depending on the type of document you want to scan.

Scan (Image Type)		Resolution	Scan Type
Photo	Use for scanning photo images.	300 x 300 dpi	24bit Color
Web	Use for attaching the scanned image to web pages.	100 x 100 dpi	24bit Color
Text	Use for scanning text documents.	200 x 200 dpi	Black & White

2. Resolution

Select a scanning resolution from the **Resolution** drop-down list. Higher resolutions produce a finer scanned image but consume more memory and increase transfer time.



Only 300 × 300dpi can be selected when using long paper.

3. Scan Type

Select from a range of scan color depths.

- **Auto**

Automatically detects whether the document uses color and generates a scanned image of it. For documents that mix color and black and white pages, color pages will be scanned in Color mode, while black and white pages will be scanned in **Black & White** mode.

- **Black & White**

Use for text or line art images.

- **True Gray**

Use for photographic images or graphics. This mode is more accurate because it uses up to 256 shades of gray.

- **24bit Color**

Use to create an image with the most accurate color reproduction. This mode uses up to 16.8 million colors to scan the image, but it requires the most memory and has the longest transfer time.

4. Document Size

Select the exact size of your document from a selection of preset scan sizes. If you select **Custom**, the **Custom Document Size** dialog box appears and you can specify the document size.

5. Binding Method

Select **Long-edge binding** or **Short-edge binding** if you selected the **2 in 1** option in the **Document Size** settings.

6. 2-sided Scanning

Scan both sides of the document.



Load only one document per scanning sequence when **Carrier Sheet Mode** or **Plastic Card Mode** is selected.

7. Auto rotate rear image 180 degrees

Rotates the scanned image on the reverse side of the page 180 degrees.

8. Advanced Settings

Configure advanced settings by clicking the **Advanced Settings** button in the Scanner Setup dialog box.

- **Paper Detection**

- **Auto Deskew**

Set the machine to correct document skewing automatically.



Because the **Auto Deskew** feature is automatically set to On if you select Auto for the **Document Size** and set to Off if you select fixed for the **Document Size**, you cannot change the **Auto Deskew** setting.

- **Auto Image Rotation**

Changes the direction of the document based on the text orientation.

- **Detect End of Page**

Detects the end of page and automatically adjusts the size of a page when the length of the document is shorter than the **Document Size** selected.

- **Document Event Capture** (Multifeed Detection)

When your machine detects a multifeed or a document size difference, you must confirm that the data scanned so far has been saved, and then start scanning again from the next page or the beginning of the document.

- Load documents of the same paper weight and size in the Paper Guides.

- Suitable paper weight: 0.11 lb to 0.46 lb (50 g/m² to 209 g/m²).

- Make sure the top of each page is not aligned. (Separation between documents of more than 0.33mm to 20.33mm needed.)

-
- Make sure the first page is loaded first.
 - Make sure the document is not crooked. (Less than a 3° horizontal skew, 0.7° skew between documents.)
 - Will not work when the Long Paper option is selected.



-
- After loading the first page, the machine will pause for up to four seconds for document analysis.
 - We recommend disabling this setting when you are scanning thick paper to avoid feeding error.
-

- **Image Quality**

- **B&W Threshold Adjustment**

- This setting allows you to adjust the image quality when scanning in **Black & White** mode. Larger values increase the amount of black in the scanned image, while smaller values increase the amount of white.

- **Grayscale Adjustment**

- This function adjusts the brightness and contrast to create gray images.

- Brightness**

- Set the **Brightness** level by moving the slider to the right or left to lighten or darken the image. If the scanned image is too light, set a lower brightness level and scan the document again. If the image is too dark, set a higher brightness level and scan the document again. You can also type a value in the field to set the brightness.

- Contrast**

- Increase or decrease the **Contrast** level by moving the slider to the right or left. An increase emphasizes dark and light areas of the image, while a decrease reveals more details in gray areas. You can also type a value in the field to set the contrast.

- **Color Tone Adjustment**

- Allows you to adjust the brightness, contrast and gamma during gray and color scanning.

- **Auto Color Detect Adjust**

- When scan type **Auto** is selected, you can adjust the detection level of color. Increasing the slider value makes the machine more likely to determine that a given document is a color document.

- **Background Processing**

- **Remove Bleed-through / Pattern**

- Prevent bleed-through.

- **Remove Background Color**

- Remove the base color of documents to make the scanned data more legible.

- **Color Drop**

- Select a color to remove from the scanned image.

- **Boldface Formatting**

- Emphasize the characters of the original by making them bold.

- **Blurred Character Correction**

- Correct any broken or incomplete characters in the original to make them easier to read.

- **Edge Emphasis**

- Make the characters of the original sharper.

- **Noise Reduction**

- This feature allows you to remove small dots or specks called “noise”, from the background of scanned images. Removing unwanted specks helps to reduce compressed file sizes.

- **Remove Ruled Line**





- This feature allows you to remove lines in the document. You can select the type of line direction to remove (**Vertical, Horizontal, Vertical and Horizontal**).

- **Minimum Line Length**

- Lines longer than or equal to the specified length are removed.

- **Maximum Clearance**

If lines are broken, for example due to fading of the image, the lines that are broken for an interval less than or equal to the specified broken line distance will be detected and removed.

Original Document	Scan Result	Description
There are horizontal and vertical lines. 		If you select Vertical , the vertical line is removed.
		If you select Horizontal , the horizontal line is removed.
		If you select Vertical and Horizontal , all lines are removed.

- **Punch Hole Removal**

This feature removes the punch hole markings by filling hole marks with white or the surrounding color.

- **Invert Image**

Reverse the brightness and the colors in the image.

- **Compression**

Select the size of the compressed file. If you select **Large**, the file size of the image will be large, but the quality will be good.



The following items can be selected when scanning black and white images:

- **Binding Method**
- **Blurred Character Correction**
- **Noise Reduction**

The following items can be selected when scanning color or gray images:

- **Color Tone Adjustment**
- **Color Drop**
- **Remove Background Color**
- **Boldface Formatting**
- **Punch Hole Removal**
- **Remove Bleed-through / Pattern**
- **Edge Emphasis**
- **Remove Ruled Line**

- **Page Control**

- **Carrier Sheet Mode**

Use the Carrier Sheet (not included) to scan the following document types:

- Important documents (photos, contracts)
- Thin paper (receipts)
- Irregularly-shaped paper (clippings)

- **Plastic Card Mode**

This feature automatically selects the suitable settings for scanning cards, such as driving licenses and insurance cards.

- **Margin Settings**

This feature allows you to add or remove a specific margin (from -0.12 in. to 0.12 in. (-3 mm to 3 mm)) at the edge of the image. A positive value decreases the size of the scanned image when it is output and a negative value increases the size of the scanned image when it is output.

- **Edge Fill**

Fill in the edges on four sides of the scanned image using the selected color and range.



Binding Method and **B&W Threshold Adjustment** cannot be selected when using **Edge Fill**.

- **Skip Blank Page**

Remove the document's blank pages from the scanning results.

- **Single Page Scan**

Scans one page at a time from the ADF, regardless of the number of pages in the ADF.

- **Continuous Scan**

Select this option to scan additional documents using the same settings when a scan has been completed. It is useful when you are scanning more documents than the ADF can hold or when you are scanning several documents at once.



Related Information

- [Scan Using Nuance™ PaperPort™ 14 or Other Windows® Applications](#)
-

Scan Using Windows® Photo Gallery or Windows® Fax and Scan

Windows® Photo Gallery or Windows® Fax and Scan applications are other options that you can use for scanning.

These applications use the WIA scanner driver.

1. Load your document.
2. Launch your scanning application. Do one of the following:
 - Windows® Photo Gallery
Click **File > Import from Camera or Scanner**.
 - Windows® Fax and Scan
Click **File > New > Scan**.
3. Select the scanner you want to use.
4. Click **Import** or **OK**.

The **New Scan** dialog box appears.

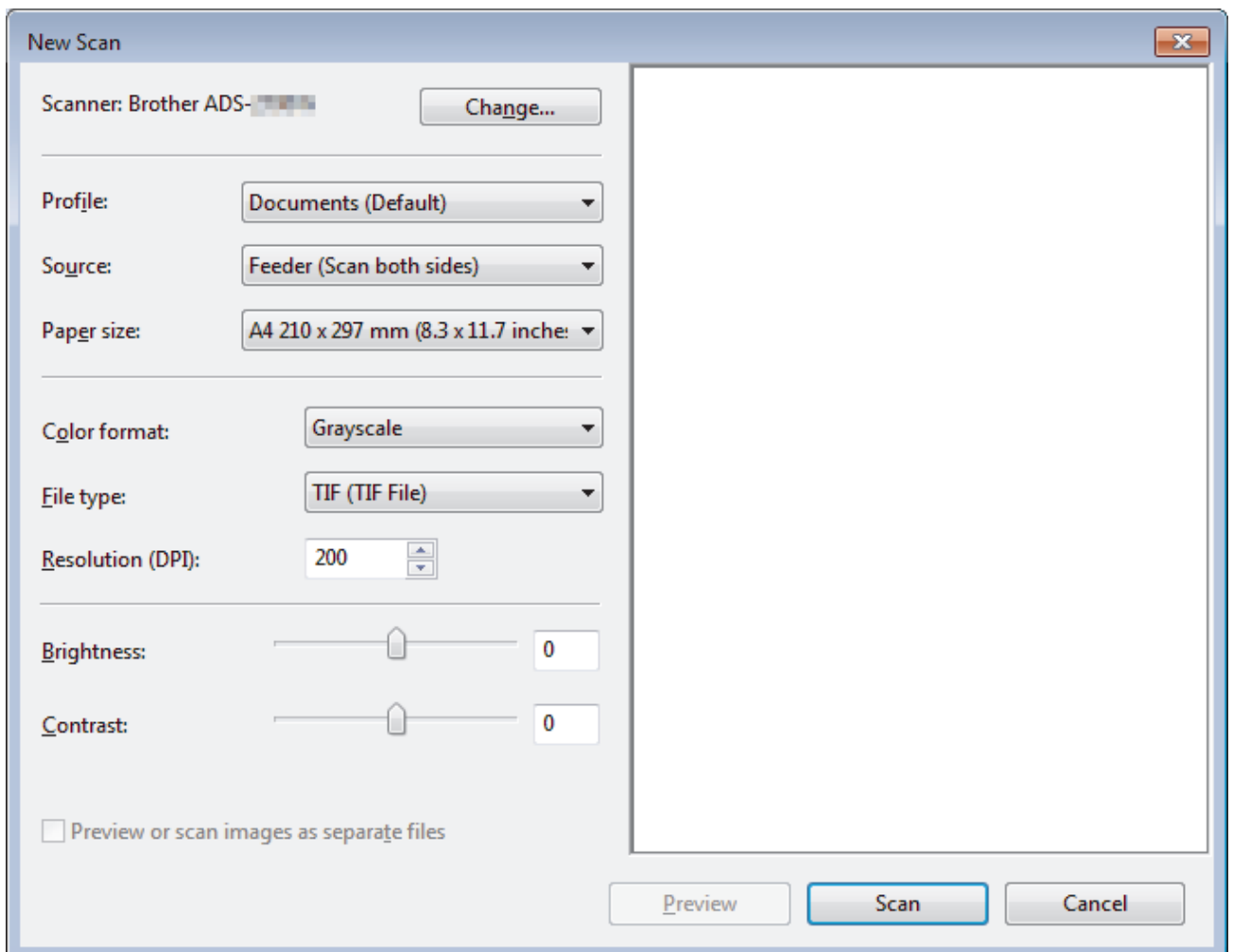

5. Adjust the settings in the Scanner Setup dialog box, if needed.
6. Click **Scan**.
The machine starts scanning.

✓ Related Information

- [Scan from Your Computer \(Windows®\)](#)

-
- WIA Driver Settings (Windows®)
-

WIA Driver Settings (Windows®)

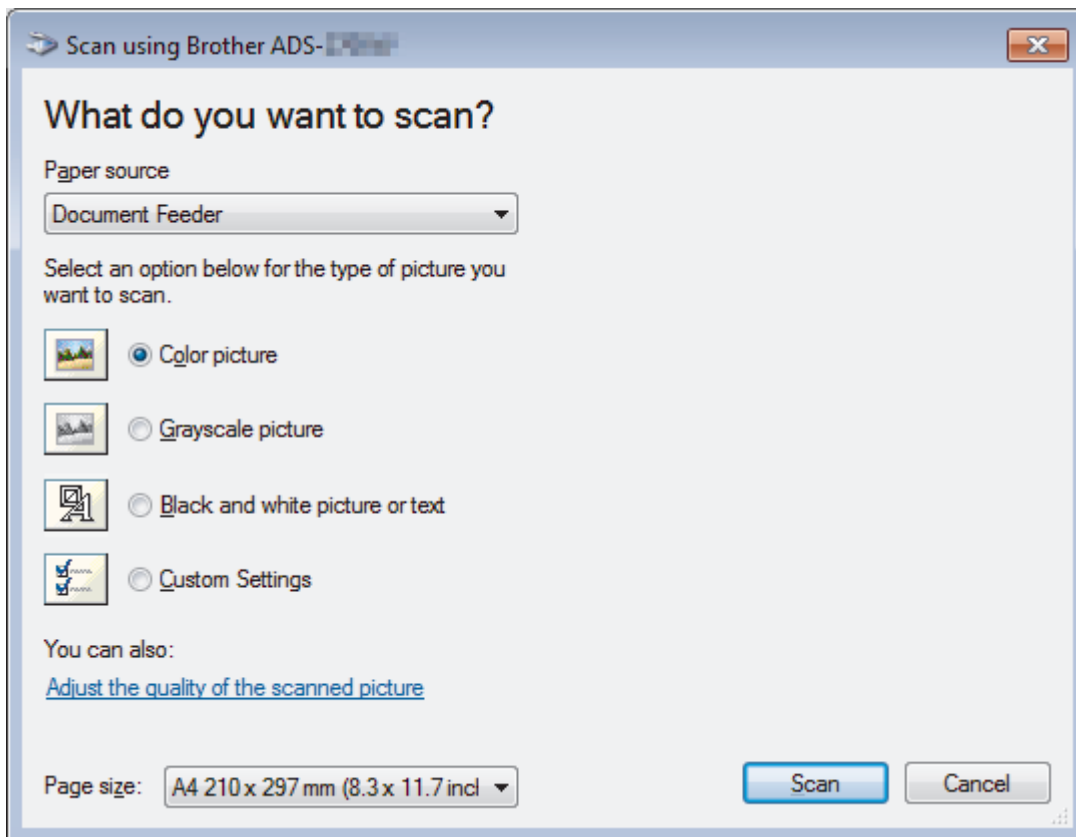

1. Paper source

You can select **Document Feeder** only.

2. Picture Type (Image Type)

Select **Color picture**, **Grayscale picture**, **Black and white picture or text**, or **Custom Settings** for the type of document you want to scan.

To change advanced settings, click the **Adjust the quality of the scanned picture** link.

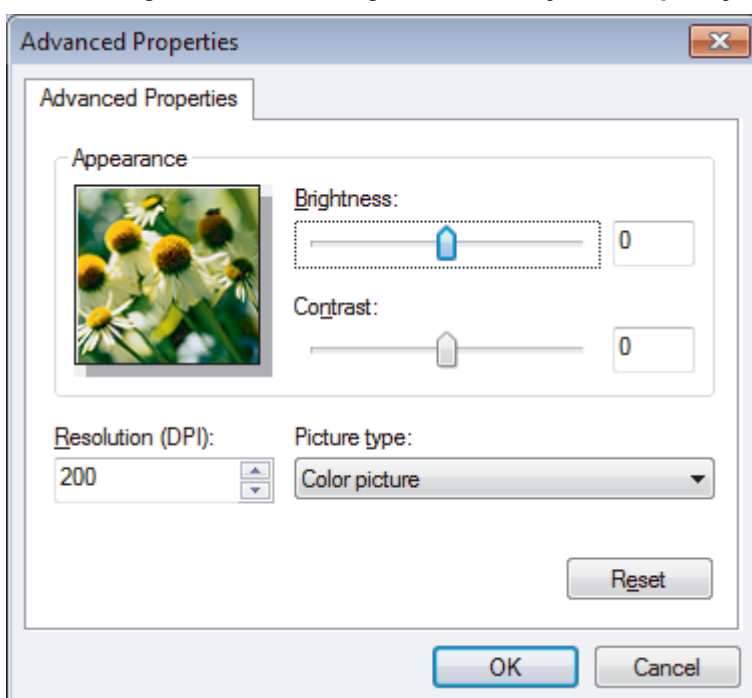

1. **Brightness**

Set the **Brightness** level by moving the slider to the right or left to lighten or darken the image. If the scanned image is too light, set a lower brightness level and scan the document again. If the image is too dark, set a higher brightness level and scan the document again.

2. **Contrast**

Increase or decrease the **Contrast** level by moving the slider to the right or left. An increase emphasizes dark and light areas of the image, while a decrease reveals more details in gray areas. You can also type a value in the field to set the contrast level.

3. **Resolution (DPI)**

Select a scanning resolution from the **Resolution (DPI)** list. Higher resolutions produce a finer scanned image but consume more memory and increase transfer time.

4. **Picture type**

Select or change the type of document you want to scan.



Related Information

- [Scan Using Windows® Photo Gallery or Windows® Fax and Scan](#)

Scan from Your Computer (Mac)

There are several ways you can use your Mac to scan documents on your Brother machine. Use the software applications provided by Brother or your favorite scanning application.

- [Scan Using Brother iPrint&Scan](#)
- [Scan Using TWAIN-Compliant Applications \(Mac\)](#)
- [Scan Using Apple Image Capture \(ICA Driver\)](#)

Scan Using Brother iPrint&Scan

Use Brother iPrint&Scan for Mac to scan from your computer. Download and install Brother iPrint&Scan from the App Store.

1. In the **Finder** menu bar, click **Go > Applications**, and then double-click the iPrint&Scan icon.
The Brother iPrint&Scan screen appears.
2. If your Brother machine is not selected, click the **Select your Machine** button, and then follow the on-screen instructions to select your Brother machine.
3. Click the **Scan** icon, and then follow the on-screen instructions to scan your documents.



Related Information

- [Scan from Your Computer \(Mac\)](#)
-

Scan Using TWAIN-Compliant Applications (Mac)

You can scan using TWAIN-compliant applications. For more information about the scanning procedure, see the manual for your application.

1. Start your graphics application, and then select the scan operation.

The scanner setup dialog box appears.

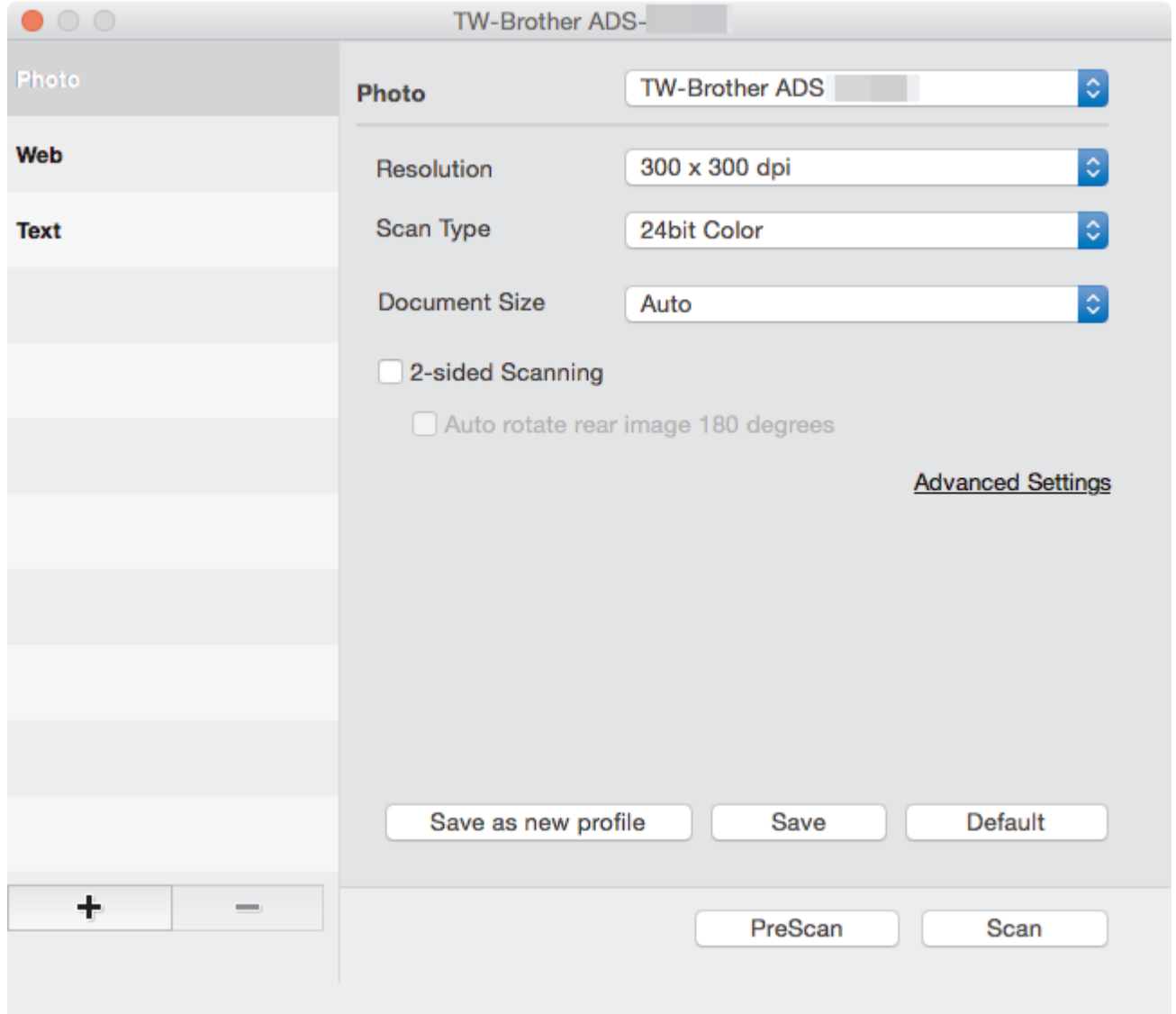

2. (ADS-2700W) Click the device selection menu, and then select your model name (if not already selected).
3. Adjust the settings in the Scanner Setup dialog box, if needed.
4. Click the **Document Size** pop-up menu, and then select your document size.
5. Click the **PreScan** option to preview your image and crop unwanted portions before scanning.
6. Press **Scan**.

The machine starts scanning.

✓ Related Information

- [Scan from Your Computer \(Mac\)](#)
- [TWAIN Driver Settings \(Mac\)](#)

TWAIN Driver Settings (Mac)

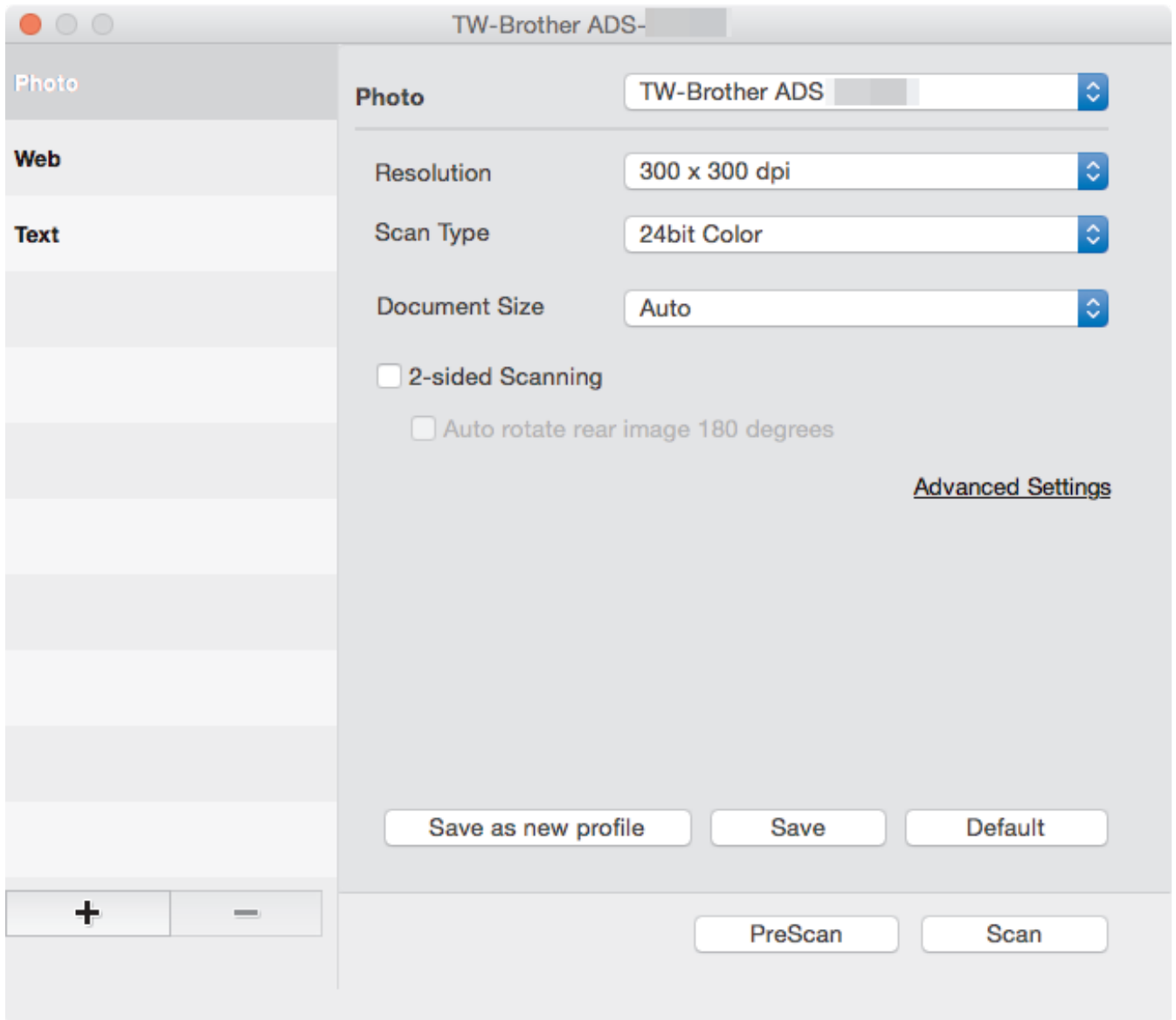

The options and settings available vary depending on the machine.

1. Resolution

Select a scanning resolution from the **Resolution** pop-up menu. Higher resolutions produce a finer scanned image but consume more memory and increase transfer time.

2. Scan Type

Select from a range of scan color depths.

- **Auto**

Automatically detects whether the document uses color and generates a scanned image of it. For documents that mix color and black and white pages, color pages will be scanned in Color mode, while black and white pages will be scanned in **Black & White** mode.

- **Black & White**

Use for text or line art images.

- **Gray (Error Diffusion)**

- **True Gray**

Use for photographic images or graphics. This mode is more accurate because it uses up to 256 shades of gray.

- **24bit Color**

Use to create an image with the most accurate color reproduction. This mode uses up to 16.8 million colors to scan the image, but it requires the most memory and has the longest transfer time.

3. Document Size

Select the exact size of your document from a selection of preset scan sizes. If you select **Custom**, you can specify the document size.

4. 2-sided Scanning

Scan both sides of the document.

5. Auto rotate rear image 180 degrees

Rotates the scanned image on the back page 180 degrees.

6. Advanced Settings

Configure advanced settings by clicking the **Advanced Settings** button in the Scanner Setup dialog box.

- **Image Quality**

- **Grayscale Adjustment**

This function adjusts the brightness and contrast to create gray images.

Brightness

Set the **Brightness** level by moving the slider to the right or left to lighten or darken the image. If the scanned image is too light, set a lower brightness level and scan the document again. If the image is too dark, set a higher brightness level and scan the document again. You can also type a value in the field to set the brightness.

Contrast

Increase or decrease the **Contrast** level by moving the slider to the right or left. An increase emphasizes dark and light areas of the image, while a decrease reveals more details in gray areas. You can also type a value in the field to set the contrast.

- **Color Tone Adjustment**

Allows you to adjust the brightness, contrast and gamma during gray and color scanning.

- **Auto Color Detect Adjust**

When scan type **Auto** is selected, you can adjust the detection level of color. Increasing the slider value makes the machine more likely to determine that a given document is a color document.

- **Noise Reduction**

This feature allows you to remove small dots or specks called “noise”, from the background of scanned images. Removing unwanted specks helps to reduce compressed file sizes.

- **Page Control**

- **Continuous Scan**

Select this option to scan additional documents using the same settings when a scan has been completed. It is useful when you are scanning more documents than the ADF can hold or when you are scanning several documents at once.



Related Information

- [Scan Using TWAIN-Compliant Applications \(Mac\)](#)
-

Scan Using Apple Image Capture (ICA Driver)

You can scan a document using the ICA driver. If you installed the Full Driver and Software Package from the Brother Solutions Center at support.brother.com, the ICA driver is already installed on your computer. You can also scan directly using the **Image Capture** application.

Related Information

- [Scan from Your Computer \(Mac\)](#)
 - [Scan Using Apple Image Capture](#)
 - [ICA Driver Settings](#)
-

Scan Using Apple Image Capture

1. Launch the **Image Capture** application.



2. Select the machine from the list on the left side of the screen.

If you connected the Brother machine to your Mac with a USB cable, you will see the machine in the **DEVICES** area. If connected via LAN, you will see it in the **SHARED** area.

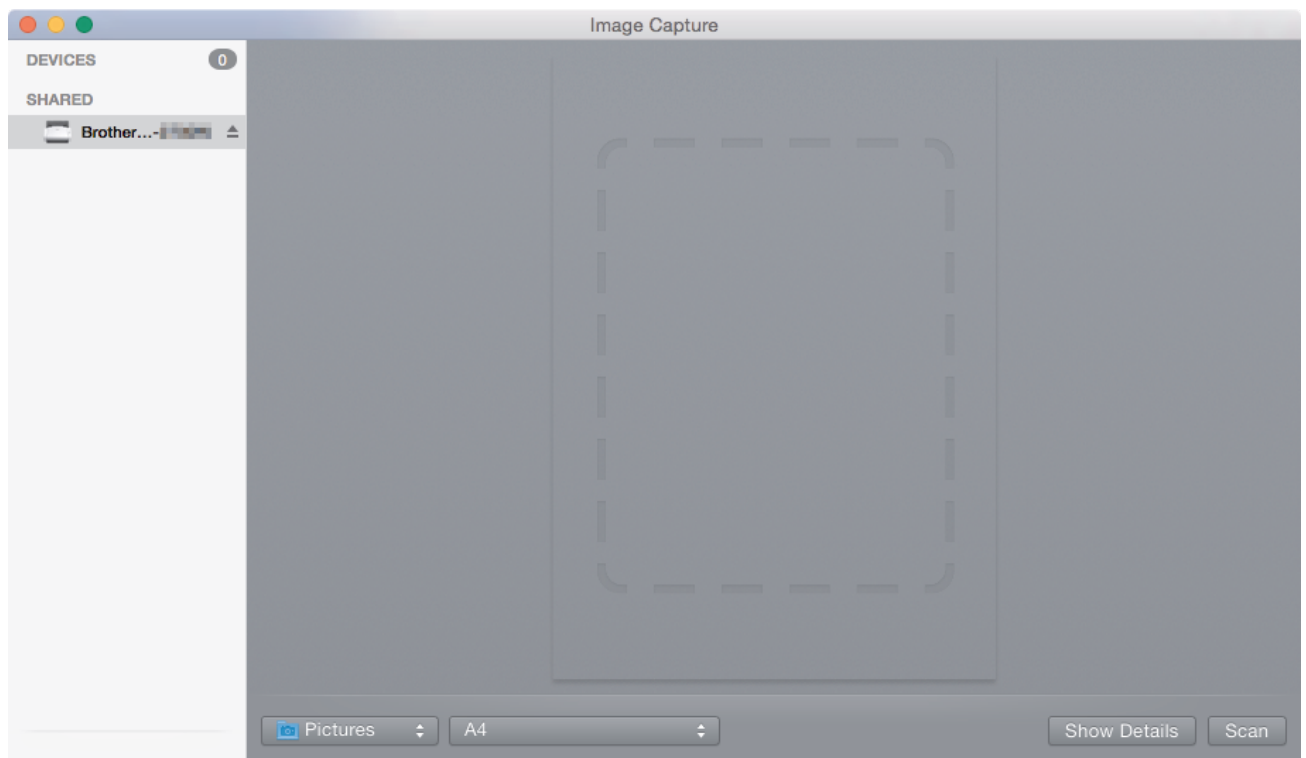

3. Load your document.
4. Select the size of your document.
5. Select the destination folder or destination application from the **Scan To** pop-up menu.
6. Click **Scan**.

The machine starts scanning.

✓ Related Information

- [Scan Using Apple Image Capture \(ICA Driver\)](#)

ICA Driver Settings

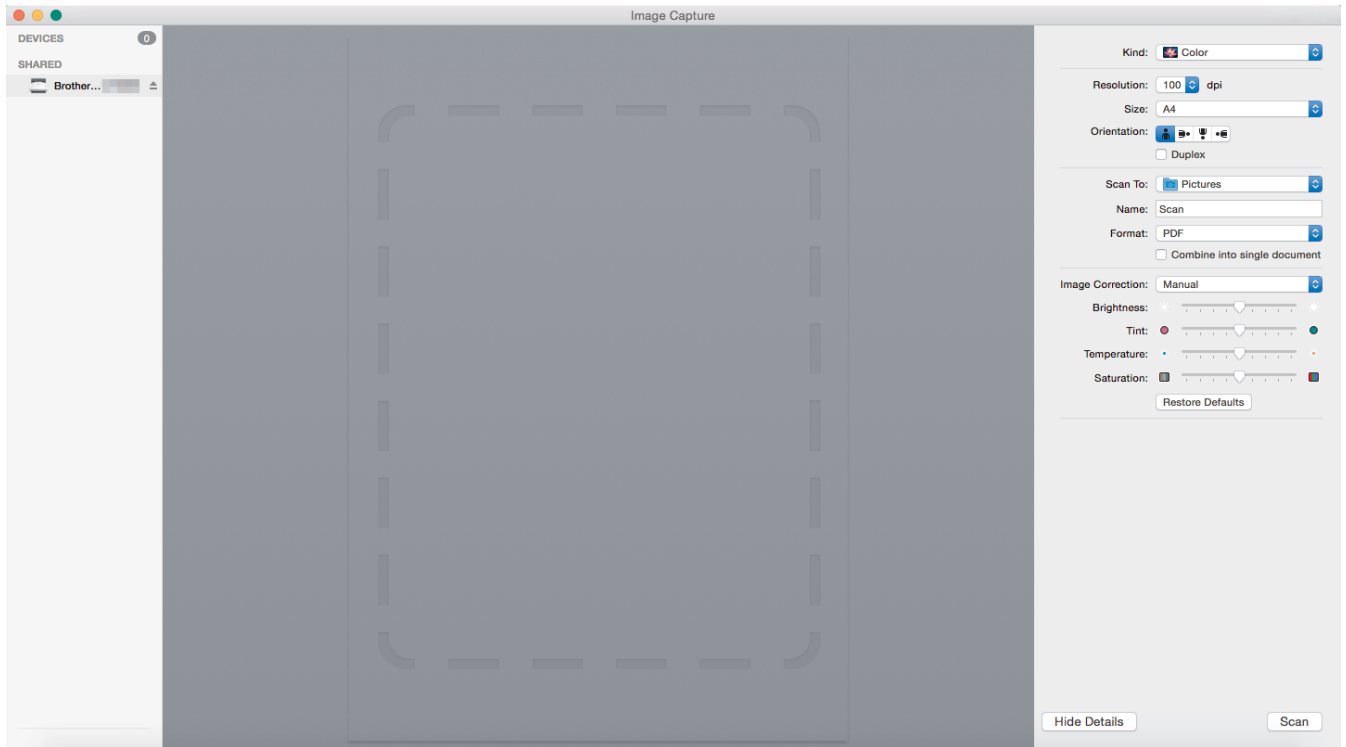

To adjust image capture settings, click **Show Details**.



Item names and assignable values may vary depending on the machine.

1. Kind

Allows you to select from **Color**, **Black&White**, or **Text**.

2. Resolution

Specifies the document resolution you want.

3. Scan Size/Size

Specifies the paper size of the document.

4. Orientation

Specifies the orientation of the document.

5. Duplex

Allows you to select the **Duplex** check box to perform 2-sided (duplex) scanning.

6. Scan To

Specifies the destination folder or destination application.

7. Name

Allows you to enter the prefix text used for the name of the scanned image.

8. Format

Specifies the file format of the scanned data.

9. Combine into single document

Allows you to scan a document as one item and save it as one file when selecting PDF or TIFF for the file format.

10. Image Correction

Depending on the **Kind** option selected, it allows you to configure the following settings:

Kind	Configurable Settings
Color	Brightness, Tint, Temperature, Saturation
Black&White	Brightness, Contrast
Text	Threshold



Related Information

- [Scan Using Apple Image Capture \(ICA Driver\)](#)
-

Network

- [Supported Basic Network Features](#)
- [Network Management Software and Utilities](#)
- [Additional Methods of Configuring Your Brother Machine for a Wireless Network](#)
- [Advanced Network Features](#)
- [Technical Information for Advanced Users](#)

Supported Basic Network Features

Related Models: ADS-2700W

The machine supports various features depending on the operating system. Use this table to see which network features and connections are supported by each operating system.

Operating Systems	Windows® XP (SP3) Windows® 7 (SP1) Windows® 8 Windows® 8.1 Windows® 10	Windows Server® 2008 R2 (SP1)/2012/2012 R2/2016	macOS v10.10.5 macOS v10.11.x macOS v10.12.x
Scanning	Yes	Yes	Yes
BRAdmin Light ¹	Yes		
Web Based Management	Yes	Yes	Yes
Remote Setup	Yes		Yes



Related Information

- [Network](#)

¹ BRAdmin Light is available as a download from your model's **Downloads** page at support.brother.com.

Network Management Software and Utilities

Configure and change your Brother machine's network settings using a management utility.

- [Learn about Network Management Software and Utilities](#)

Learn about Network Management Software and Utilities

Related Models: ADS-2700W

Web Based Management

Web Based Management is a utility that uses a standard web browser to manage your machine using the Hyper Text Transfer Protocol (HTTP) or Hyper Text Transfer Protocol over Secure Socket Layer (HTTPS). Type your machine's IP address into your web browser to access and change your scanner settings.

BRAdmin Light (Windows®)

BRAdmin Light is a utility for the initial setup of Brother network-connected devices. This utility can search for Brother products on your network, view the status and configure the basic network settings, such as IP address. Go to your model's **Downloads** page on the Brother Solutions Center at support.brother.com to download the latest version of Brother's BRAdmin Light.



- If using Windows® Firewall, or the firewall function of an anti-spyware or antivirus application, temporarily disable them. When you are sure you can scan, configure the software settings by following the manufacturer's instructions.

Remote Setup (Windows® and Mac)

Remote Setup is a program for configuring many machine and network settings from either a Windows® or a Mac application. When you start this application, the settings on your machine are automatically downloaded to your computer and displayed on your computer screen. If you change the settings, you can upload them directly to the machine.



This utility can be used with either a USB or a network connection.



Related Information

- [Network Management Software and Utilities](#)

Additional Methods of Configuring Your Brother Machine for a Wireless Network

- [Before Configuring Your Brother Machine for a Wireless Network](#)
- [Configure Your Machine for a Wireless Network Using the One-Push Method of Wi-Fi Protected Setup™ \(WPS\)](#)
- [Configure Your Machine for a Wireless Network Using the PIN Method of Wi-Fi Protected Setup™ \(WPS\)](#)
- [Configure Your Machine for a Wireless Network Using the Machine's Control Panel Setup Wizard](#)
- [Use Wi-Fi Direct®](#)

Before Configuring Your Brother Machine for a Wireless Network

Related Models: ADS-2700W

Before attempting to configure a wireless network, confirm the following:

- Before configuring wireless settings, you must know your Network name (SSID) and Network Key (Password). If using an enterprise wireless network, you must know the User ID and Password.



If you do not know this security information, contact the router manufacturer, your system administrator, or your Internet provider.

- To achieve optimum results with normal everyday document scanning, place the Brother machine as close to the wireless access point/router as possible with minimal obstructions. Large objects and walls between the two devices and interference from other electronic devices can affect the data transfer speed of your documents.

Due to these factors, wireless may not be the best method of connection for all types of documents and applications. If you are scanning large files, such as multi-page documents with mixed text and large graphics, you may want to consider selecting wired Ethernet for faster data transfer, or USB for the fastest throughput speed.

- Although the Brother machine can be used in both a wired and wireless network, only one connection method can be used at a time.



Related Information

- [Additional Methods of Configuring Your Brother Machine for a Wireless Network](#)

Configure Your Machine for a Wireless Network Using the One-Push Method of Wi-Fi Protected Setup™ (WPS)

Related Models: ADS-2700W

If your wireless access point/router supports Wi-Fi Protected Setup™ (WPS), you can use WPS from your machine's control panel menu to configure your wireless network settings.



Routers or access points that support WPS are marked with this symbol:



1. Press  [Settings] > [Network] > [WLAN] > [WPS].
2. When [Enable WLAN? The Wired Network I/F will be disabled. Do you want to continue?] appears, press [Yes].
The wireless setup wizard starts. To cancel, press [No].
3. When the touchscreen instructs you to start WPS, press the WPS button on your wireless access point/router. Press [OK], and then your machine automatically tries to connect to your wireless network.

If your wireless device is connected successfully, the LCD displays [Connected].

You have completed the wireless network setup. To install drivers and software necessary for operating your device, go to your model's **Downloads** page on the Brother Solutions Center at support.brother.com.

To configure additional Network Settings, use the Web Based Management. See *Related Information: Access Web Based Management*



Related Information

- [Additional Methods of Configuring Your Brother Machine for a Wireless Network](#)
- [Access Web Based Management](#)

Configure Your Machine for a Wireless Network Using the PIN Method of Wi-Fi Protected Setup™ (WPS)

Related Models: ADS-2700W

If your wireless access point/router supports WPS, you can use the Personal Identification Number (PIN) Method to configure your wireless network settings.

The PIN Method is one of the connection methods developed by the Wi-Fi Alliance®. By submitting a PIN created by an Enrollee (your machine) to the Registrar (a device that manages the wireless LAN), you can set up the wireless network and security settings. For more information on how to access WPS mode, see the instructions provided with your wireless access point/router.

Type A

Connection when the wireless access point/router (1) doubles as the Registrar.

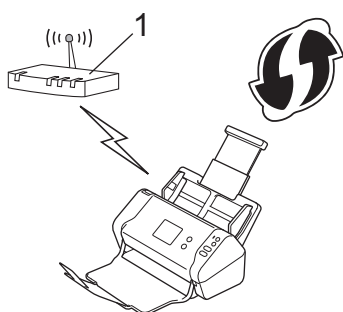

Type B

Connection when another device (2), such as a computer, is used as the Registrar.

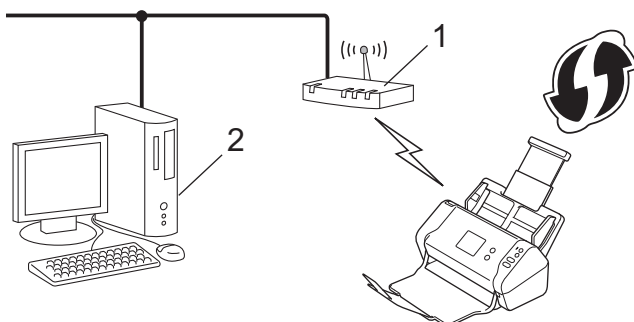

Routers or access points that support WPS are marked with this symbol:



1. Press  [Settings] > [Network] > [WLAN] > [WPS w/ PIN Code].
2. When [Enable WLAN? The Wired Network I/F will be disabled. Do you want to continue?] appears, press [Yes].
The wireless setup wizard starts. To cancel, press [No].
3. The LCD displays an eight-digit PIN and the machine starts searching for a wireless access point/router.

4. Using a computer connected to the network, in your browser's address bar, type the IP address of the device you are using as the Registrar. (For example: <http://192.168.1.2>)
5. Go to the WPS settings page and type the PIN, and then follow the on-screen instructions.



- The Registrar is usually the wireless access point/router.
- The settings page will differ depending on the brand of wireless access point/router. For more detailed information, see the instructions supplied with your wireless access point/router.

If using a Windows® 7, Windows® 8, Windows® 8.1, or Windows® 10 computer as a Registrar, complete the following steps:

6. Do one of the following:

- Windows® 10

Click  > **Windows System** > **Control Panel**. In the **Hardware and Sound** group, click **Add a device**.

- Windows® 8 and Windows® 8.1

Move your mouse to the lower right corner of your desktop. When the menu bar appears, click **Settings** > **Control Panel** > **Hardware and Sound** > **Devices and Printers** > **Add a device**.

- Windows® 7

Click  (**Start**) > **Devices and Printers** > **Add a device**.



- To use Windows® 7, Windows® 8, Windows® 8.1, or Windows® 10 computer as a Registrar, you must register it to your network in advance. For more detailed information, see the instructions supplied with your wireless access point/router.
- If you use Windows® 7, Windows® 8, Windows® 8.1, or Windows® 10 as a Registrar, you can install the scanner driver after the wireless configuration by following the on-screen instructions. To install the full driver and software package, see the *Quick Setup Guide*.

7. Select your machine and click **Next**.
8. Type the PIN displayed on the machine's LCD, and then click **Next**.
9. (Windows® 7 only) Select your network, and then click **Next**.
10. Click **Close**.

If your wireless device is connected successfully, the LCD displays [Connected].

You have completed the wireless network setup. To install drivers and software necessary for operating your device, go to your model's **Downloads** page on the Brother Solutions Center at support.brother.com.

To configure additional Network Settings, use the Web Based Management. See *Related Information: Access Web Based Management*



Related Information

- [Additional Methods of Configuring Your Brother Machine for a Wireless Network](#)
- [Access Web Based Management](#)

Configure Your Machine for a Wireless Network Using the Machine's Control Panel Setup Wizard

Related Models: ADS-2700W

Before configuring your machine, we recommend writing down your wireless network settings. You will need this information before you continue with the configuration.

1. Check and write down the current wireless network settings.

Network Name (SSID)

Network Key (Password)

For example:

Network Name (SSID)

HELLO

Network Key (Password)

12345



If your router uses WEP encryption, enter the Network Key (Password) used as the first WEP key. Your Brother machine supports the use of the first WEP key only.

2. Press  [Settings] > [Network] > [WLAN] > [Setup Wizard].
3. When [Enable WLAN? The Wired Network I/F will be disabled. Do you want to continue?] appears, press [Yes].
The wireless setup wizard starts. To cancel, press [No].
4. The machine searches for your network and displays a list of available SSIDs. Press ▲ or ▼ to display the SSID you want to connect to, and then press it.
5. Press [OK].
6. Do one of the following:
 - If using an authentication and encryption method that requires a Network Key (Password), enter the Network Key (Password) you wrote down in the first step.
When you have entered all the characters, press [OK].
 - If your authentication method is Open System and your encryption mode is None, go to the next step.
7. The machine attempts to connect to the wireless device you have selected.

If your wireless device is connected successfully, the LCD displays [Connected].

You have completed the wireless network setup. To install drivers and software necessary for operating your device, go to your model's **Downloads** page on the Brother Solutions Center at support.brother.com.

To configure additional Network Settings, use the Web Based Management. See *Related Information: Access Web Based Management*



Related Information

- [Additional Methods of Configuring Your Brother Machine for a Wireless Network](#)

-
- Access Web Based Management
-

Use Wi-Fi Direct®

- [Scan from Your Mobile Device Using Wi-Fi Direct](#)
- [Configure Your Wi-Fi Direct Network](#)

Scan from Your Mobile Device Using Wi-Fi Direct

Related Models: ADS-2700W

Wi-Fi Direct is one of the wireless configuration methods developed by the Wi-Fi Alliance®. It allows you to configure a secured wireless network between your Brother machine and a mobile device, such as an Android™ device, Windows® device, iPhone, iPod touch, or iPad, without using an access point. Wi-Fi Direct supports wireless network configuration using the one-push or PIN Method of Wi-Fi Protected Setup™ (WPS). You can also configure a wireless network by manually setting a SSID and password. Your Brother machine's Wi-Fi Direct feature supports WPA2™ security with AES encryption.

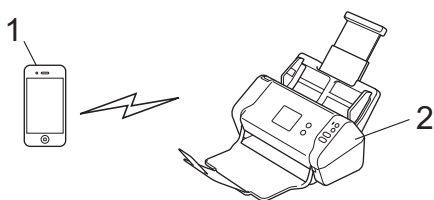

1. Mobile device
2. Your Brother machine



Although the Brother machine can be used in both a wired and wireless network, only one connection method can be used at a time.



Related Information

- [Use Wi-Fi Direct®](#)

Configure Your Wi-Fi Direct Network

Configure your Wi-Fi Direct network settings from your machine's control panel.

- [Wi-Fi Direct Network Configuration Overview](#)
- [Configure Your Wi-Fi Direct Network Using the One-Push Method](#)
- [Configure Your Wi-Fi Direct Network Using the One-Push Method of Wi-Fi Protected Setup™ \(WPS\)](#)
- [Configure Your Wi-Fi Direct Network Using the PIN Method](#)
- [Configure Your Wi-Fi Direct Network Using the PIN Method of Wi-Fi Protected Setup™ \(WPS\)](#)
- [Configure Your Wi-Fi Direct Network Manually](#)

Wi-Fi Direct Network Configuration Overview

Related Models: ADS-2700W

The following instructions offer five methods for configuring your Brother machine in a wireless network environment. Select the method you prefer for your environment.

Check your mobile device for configuration.

1. Does your mobile device support Wi-Fi Direct?

Option	Description
Yes	Go to Step 2
No	Go to Step 3

2. Does your mobile device support one-push configuration for Wi-Fi Direct?

Option	Description
Yes	See <i>Related Information</i> : Configure Your Wi-Fi Direct Network Using the One-Push Method
No	See <i>Related Information</i> : Configure Your Wi-Fi Direct Network Using the PIN Method

3. Does your mobile device support Wi-Fi Protected Setup™ (WPS)?

Option	Description
Yes	Go to Step 4
No	See <i>Related Information</i> : Configure Your Wi-Fi Direct Network Manually

4. Does your mobile device support one-push configuration for Wi-Fi Protected Setup™ (WPS)?

Option	Description
Yes	See <i>Related Information</i> : Configure Your Wi-Fi Direct Network Using the One-Push Method of Wi-Fi Protected Setup™ (WPS)
No	See <i>Related Information</i> : Configure Your Wi-Fi Direct Network Using the PIN Method of Wi-Fi Protected Setup™ (WPS)

To use Brother iPrint&Scan functionality in a Wi-Fi Direct network configured by one-push configuration using Wi-Fi Direct, or by PIN Method configuration using Wi-Fi Direct, the device you use to configure Wi-Fi Direct must be running Android™ 4.0 or greater.



Related Information

- [Configure Your Wi-Fi Direct Network](#)
- [Configure Your Wi-Fi Direct Network Using the One-Push Method](#)
- [Configure Your Wi-Fi Direct Network Using the PIN Method](#)
- [Configure Your Wi-Fi Direct Network Manually](#)
- [Configure Your Wi-Fi Direct Network Using the One-Push Method of Wi-Fi Protected Setup™ \(WPS\)](#)

-
- Configure Your Wi-Fi Direct Network Using the PIN Method of Wi-Fi Protected Setup™ (WPS)
-

Configure Your Wi-Fi Direct Network Using the One-Push Method

Related Models: ADS-2700W

If your mobile device supports Wi-Fi Direct, follow these steps to configure a Wi-Fi Direct network:



When the machine receives the Wi-Fi Direct request from your mobile device, the message [Wi-Fi Direct Connection request received. Press [OK] to connect. Device Name:] appears on the LCD. Press [OK] to connect.

1. Press  [Settings] > [Network] > [Wi-Fi Direct] > [Push Button].
2. Activate Wi-Fi Direct on your mobile device (see your mobile device's user's guide for instructions) when [Activate Wi-Fi Direct on the other device. Then Press [OK].] appears. Press [OK] on your Brother machine.

This will start the Wi-Fi Direct setup.

If your mobile device connects successfully, the machine displays [Connected]. You have completed the Wi-Fi Direct network setup.



Related Information

- [Configure Your Wi-Fi Direct Network](#)

Configure Your Wi-Fi Direct Network Using the One-Push Method of Wi-Fi Protected Setup™ (WPS)

Related Models: ADS-2700W

If your mobile device supports Wi-Fi Protected Setup™ (WPS), follow these steps to configure a Wi-Fi Direct network:



When the machine receives the Wi-Fi Direct request from your mobile device, the message [Wi-Fi Direct Connection request received. Press [OK] to connect. Device Name:] appears on the LCD. Press [OK] to connect.

1. Press  [Settings] > [Network] > [Wi-Fi Direct] > [Push Button].
2. Activate your mobile device's WPS one-push configuration method (see your mobile device's user's guide for instructions) when [Activate Wi-Fi Direct on the other device. Then Press [OK].] appears on the machine's LCD. Press [OK] on your Brother machine.

This will start the Wi-Fi Direct setup.

If your mobile device connects successfully, the machine displays [Connected]. You have completed the Wi-Fi Direct network setup.



Related Information

- [Configure Your Wi-Fi Direct Network](#)

Configure Your Wi-Fi Direct Network Using the PIN Method

Related Models: ADS-2700W

If your mobile device supports the PIN Method of Wi-Fi Direct, follow these steps to configure a Wi-Fi Direct network:



When the machine receives the Wi-Fi Direct request from your mobile device, the message [Wi-Fi Direct Connection request received. Press [OK] to connect. Device Name:] appears on the LCD. Press [OK] to connect.

1. Press  [Settings] > [Network] > [Wi-Fi Direct] > [PIN Code].
2. Activate Wi-Fi Direct on your mobile device (see your mobile device's user's guide for instructions) when [Activate Wi-Fi Direct on the other device. Then Press [OK].] appears. Press [OK] on your Brother machine.
This will start the Wi-Fi Direct setup.
3. The machine will wait for a connection request from your mobile device. When [PIN Code] appears, enter the PIN displayed on your mobile device in the machine. Press [OK]. Follow the instructions.
If the PIN is displayed on your Brother machine, enter the PIN in your mobile device.

If your mobile device connects successfully, the machine displays [Connected]. You have completed the Wi-Fi Direct network setup.



Related Information

- [Configure Your Wi-Fi Direct Network](#)

Configure Your Wi-Fi Direct Network Using the PIN Method of Wi-Fi Protected Setup™ (WPS)

Related Models: ADS-2700W

If your mobile device supports the PIN Method of Wi-Fi Protected Setup™ (WPS), follow these steps to configure a Wi-Fi Direct network:



When the machine receives the Wi-Fi Direct request from your mobile device, the message [Wi-Fi Direct Connection request received. Press [OK] to connect. Device Name:] appears on the LCD. Press [OK] to connect.

1. Press  [Settings] > [Network] > [Wi-Fi Direct] > [PIN Code].
2. When [Activate Wi-Fi Direct on the other device. Then Press [OK].] is displayed, activate your mobile device's WPS PIN configuration method (see your mobile device's user's guide for instructions), and then press [OK] on your Brother machine.
This will start the Wi-Fi Direct setup.
3. The machine will wait for a connection request from your mobile device. When [PIN Code] appears, enter the PIN displayed on your mobile device in the machine. Press [OK].

If your mobile device connects successfully, the machine displays [Connected]. You have completed the Wi-Fi Direct network setup.



Related Information

- [Configure Your Wi-Fi Direct Network](#)

Configure Your Wi-Fi Direct Network Manually

Related Models: ADS-2700W

If your mobile device does not support Wi-Fi Direct or WPS, you must configure a Wi-Fi Direct network manually.

1. Press  [Settings] > [Network] > [Wi-Fi Direct] > [Manual].
2. The machine will display the SSID name and Password. Go to your mobile device's wireless network settings screen and enter the SSID name and password.

If your mobile device connects successfully, the machine displays [Connected]. You have completed the Wi-Fi Direct network setup.



Related Information

- [Configure Your Wi-Fi Direct Network](#)

Advanced Network Features

- [Synchronize Time with the SNTP Server Using Web Based Management](#)

Synchronize Time with the SNTP Server Using Web Based Management

The Simple Network Time Protocol (SNTP) is used to synchronize the time used by the machine for authentication with the SNTP time server. (This is not the time displayed on the machine's LCD.) You can automatically or manually synchronize the machine's time with the Coordinated Universal Time (UTC) provided by the SNTP time server.

- [Configure Date and Time Using Web Based Management](#)
- [Configure the SNTP Protocol Using Web Based Management](#)

Configure Date and Time Using Web Based Management

Related Models: ADS-2700W

Configure the date and time to synchronize the time used by the machine with the SNTP time server.

This feature is not available in some countries.

1. Start your web browser.
2. Type "http://machine's IP address" in your browser's address bar (where "machine's IP address" is the machine's IP address).
For example:
http://192.168.1.2
3. By default, no password is required. If you have previously set a password, type it, and then click .
4. Click the **Administrator** tab.
5. Click **Date&Time** in the left navigation bar.

Date&Time

Date / /

Clock Type 12h Clock 24h Clock

Time : (24 hr.)

Time Zone

Auto Daylight Off On

Synchronize with SNTP server

To synchronize the "Date&Time" with your SNTP server you must configure the SNTP server settings.

[SNTP>>](#)

6. Select the time difference between your location and UTC from the **Time Zone** drop-down list.
For example, the time zone for Eastern Time in the USA and Canada is UTC-05:00.
7. Select the **Synchronize with SNTP server** check box.

8. Click **Submit**.



Related Information

- [Synchronize Time with the SNTP Server Using Web Based Management](#)
-

Configure the SNTP Protocol Using Web Based Management

Related Models: ADS-2700W

Configure the SNTP protocol to synchronize the time the machine uses for authentication with the time kept by the SNTP time server.

This feature is not available in some countries.

1. Start your web browser.
2. Type "http://machine's IP address" in your browser's address bar (where "machine's IP address" is the machine's IP address).
For example:
http://192.168.1.2
3. By default, no password is required. If you have previously set a password, type it, and then click .
4. Click the **Network** tab.
5. Click the **Protocol** menu in the left navigation bar.
6. Select the **SNTP** check box to activate the settings.
7. Restart your Brother machine to activate the configuration.
8. Next to the SNTP check box, click **Advanced Setting** and configure your settings as needed.

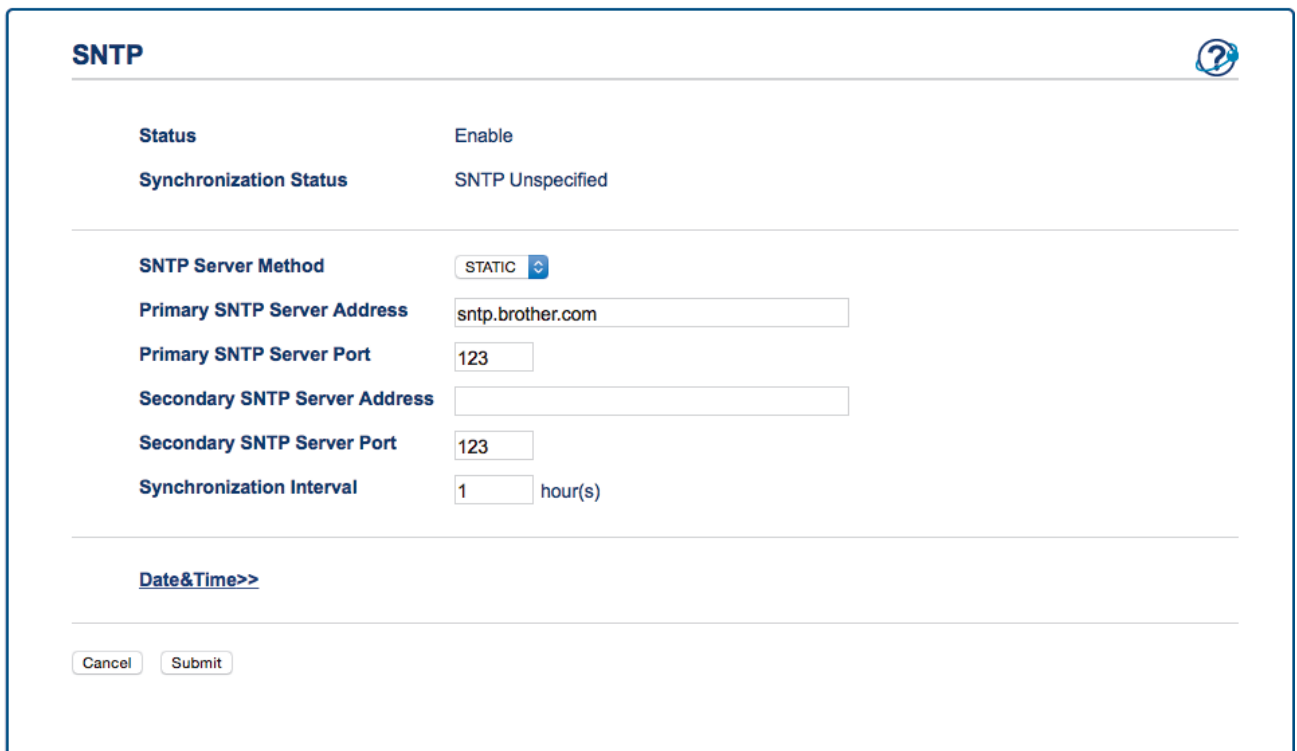

SNTP 

Status Enable

Synchronization Status SNTP Unspecified

SNTP Server Method STATIC 

Primary SNTP Server Address

Primary SNTP Server Port

Secondary SNTP Server Address

Secondary SNTP Server Port

Synchronization Interval hour(s)

[Date&Time>>](#)

Option	Description
Status	Displays whether the SNTP protocol is enabled or disabled.
Synchronization Status	Confirm the latest synchronization status.
SNTP Server Method	Select AUTO or STATIC . <ul style="list-style-type: none">• AUTO

Option	Description
	<p>If you have a DHCP server in your network, the SNTP server will obtain the address from that server automatically.</p> <ul style="list-style-type: none"> • STATIC <p>Type the address you want to use.</p>
<p>Primary SNTP Server Address</p> <p>Secondary SNTP Server Address</p>	<p>Type the server address (up to 64 characters).</p> <p>The secondary SNTP server address is used as a backup to the primary SNTP server address. If the primary server is unavailable, the machine will contact the secondary SNTP server.</p>
<p>Primary SNTP Server Port</p> <p>Secondary SNTP Server Port</p>	<p>Type the port number (1-65535).</p> <p>The secondary SNTP server port is used as a backup to the primary SNTP server port. If the primary port is unavailable, the machine will contact the secondary SNTP port.</p>
<p>Synchronization Interval</p>	<p>Type the number of hours between server synchronization attempts (1-168 hours).</p>

9. Click **Submit**.



Related Information

- [Synchronize Time with the SNTP Server Using Web Based Management](#)

Technical Information for Advanced Users

- [Wireless LAN Error Codes](#)

Wireless LAN Error Codes

Related Models: ADS-2700W

If the LCD displays an error code, locate the code in the table and use the recommended solution to correct the error.

Error Code	Problem and Recommended Solutions
TS-02	<p>The wireless access point/router cannot be detected.</p> <ol style="list-style-type: none"> Check the following: <ul style="list-style-type: none"> Make sure the wireless access point/router is powered on. Move your machine to an obstruction-free area, or closer to the wireless access point/router. Temporarily place your machine within about 3.3 feet (1 meter) from the wireless access point/router when you are configuring the wireless settings. If your wireless access point/router is using MAC address filtering, confirm that the MAC address of the Brother machine is allowed in the filter. If you manually entered the SSID and security information (SSID/authentication method/encryption method/Network Key (Password)), the information may be incorrect. Confirm the SSID and security information, and re-enter the correct information as necessary. <p>This device does not support a 5 GHz SSID/ESSID and you must select a 2.4 GHz SSID/ESSID. Make sure the wireless access point/router is set to 2.4 GHz or 2.4 GHz/5 GHz mixed mode.</p>
TS-04	<p>The Authentication/Encryption methods used by the selected wireless access point/router are not supported by your machine.</p> <p>Change the authentication and encryption methods of the wireless access point/router. Your machine supports the following authentication methods:</p> <ul style="list-style-type: none"> WPA-Personal TKIP or AES WPA2-Personal AES Open WEP or None (without encryption) Shared key WEP <p>If the problem is not solved, the Network Name (SSID) or network settings entered may be incorrect. Confirm the wireless network settings.</p>
TS-05	<p>The security information (SSID/Network Key (Password)) is incorrect.</p> <p>Confirm the Network Name (SSID) and the Network Key (Password).</p> <p>If your router uses WEP encryption, enter the Network Key (Password) used as the first WEP key. Your Brother machine supports the use of the first WEP key only.</p>
TS-08	<p>Two or more wireless access points that have WPS enabled are detected.</p> <ul style="list-style-type: none"> Confirm that only one wireless access point/router within range has the WPS method active and try again. Try again after a few minutes to avoid interference from other access points.



Related Information

- [Technical Information for Advanced Users](#)

Security

- [Lock the Machine Settings](#)
- [Network Security Features](#)

Lock the Machine Settings

- [Setting Lock Overview](#)

Setting Lock Overview

Use the Setting Lock feature to block unauthorized access to machine settings.

When Setting Lock is set to On, you cannot access the machine settings without entering the password.



Remote Setup will not launch when Setting Lock is set to On.

- [Set or Change the Setting Lock Password](#)
- [Turn Setting Lock On or Off](#)

Set or Change the Setting Lock Password

Related Models: ADS-2700W

1. Press  [Settings] > [General Setup] > [Setting Lock].



To change the password, press  [Settings] > [General Setup] > [Setting Lock] > [Set Password], and then enter your existing four-digit password.

2. Enter a four-digit number for the password using numbers 0-9. Press [OK].
3. When the touchscreen displays [Verify:], re-enter the new password. Press [OK].
4. Press .



Related Information

- [Setting Lock Overview](#)

Turn Setting Lock On or Off

Related Models: ADS-2700W

Use the Setting Lock feature to block unauthorized access to machine settings.

When Setting Lock is set to On, you cannot access the machine settings without entering the password.

1. Press  [Settings] > [General Setup] > [Setting Lock] > [Lock Off=>On].
2. Enter the current four-digit password. Press [OK].



To turn off Setting Lock, press  on the touchscreen, enter the current four-digit password, and then press [OK].

Related Information

- [Setting Lock Overview](#)

Network Security Features

- [Secure Function Lock 3.0](#)
- [Manage Your Network Machine Securely Using SSL/TLS](#)
- [Send an Email Securely](#)

Secure Function Lock 3.0

- [Before Using Secure Function Lock 3.0](#)
- [Configure Secure Function Lock 3.0 Using Web Based Management](#)
- [Configure Public Mode for Secure Function Lock 3.0](#)

Before Using Secure Function Lock 3.0

Related Models: ADS-2700W

Secure Function Lock lets you restrict public access to the following machine operations:

- Scan to PC
- Scan to FTP/SFTP
- Scan to Network
- Scan to USB
- Scan to Email Server
- Scan to WSS (Web Service Scan)

Secure Function Lock also prevents users from changing the default settings from the machine by limiting access to the machine's settings.

Before using the security features you should first enter an administrator password. The administrator can set up restrictions for individual users along with a user password. Carefully write down your password. If you forget it, you will have to reset the password stored in the machine. For more information about how to reset the password, contact Brother Customer Service.



- Only administrators can set limitations and make changes for each user.
- For Windows® users only:
Secure Function Lock can be set using Web Based Management.



Related Information

- [Secure Function Lock 3.0](#)

Configure Secure Function Lock 3.0 Using Web Based Management

Related Models: ADS-2700W

1. Start your web browser.
2. Type "http://machine's IP address" in your browser's address bar (where "machine's IP address" is the machine's IP address).
For example:
http://192.168.1.2
3. Type an Administrator password in the **Login** box. Click .
4. Click the **Administrator** tab.
5. Click the **User Restriction Function** menu in the left navigation bar.
6. Click the **Secure Function Lock** menu.
7. Click **Submit**.
8. Click the **User List** menu in the left navigation bar.
9. In the **User List** field, type the user name.
10. In the **PIN Number** field, type a four-digit password.
11. Select **User List / Restricted Functions** from the drop-down list for each user.
12. Click **Submit**.



Related Information

- [Secure Function Lock 3.0](#)

Configure Public Mode for Secure Function Lock 3.0

Related Models: ADS-2700W

Use the Secure Function Lock screen to set up Public Mode, which limits the functions available to public users. Public users will not need to enter a password to access the features made available through Public Mode settings.

1. Start your web browser.
2. Type "http://machine's IP address" in your browser's address bar (where "machine's IP address" is the machine's IP address).

For example:

http://192.168.1.2

3. By default, no password is required. If you have previously set a password, type it, and then click .
4. Click the **Administrator** tab.
5. Click the **Restricted Functions** menu.
6. Select **Secure Function Lock**.
7. Click **Submit**.
8. Click the **Restricted Functions** menu.
9. In the **Public Mode** row, select a check box to allow or clear a check box to restrict the function listed.
10. Click **Submit**.



Related Information

- [Secure Function Lock 3.0](#)

Manage Your Network Machine Securely Using SSL/TLS

- [Certificates and Web Based Management](#)

Certificates and Web Based Management

- [Import and Export a CA Certificate](#)
- [Manage Multiple Certificates](#)

Import and Export a CA Certificate

Related Models: ADS-2700W

1. Start your web browser.
2. Type "http://machine's IP address" in your browser's address bar (where "machine's IP address" is the machine's IP address).
For example:
http://192.168.1.2
3. By default, no password is required. If you have previously set a password, type it, and then click .
4. Click the **Network** tab.
5. Click the **Security** tab.
6. Click **CA Certificate**.
7. Do one of the following:
 - To import a CA Certificate, click **Import CA Certificate**. Browse to the file you want to import.
 - To export a CA Certificate, select the certificate you want to export and click **Export**.
8. Click **Submit**.



Related Information

- [Certificates and Web Based Management](#)

Manage Multiple Certificates

Related Models: ADS-2700W

The multiple certificate feature allows you to use Web Based Management to manage each certificate installed on your machine. In Web Based Management, navigate to the **CA Certificate** screen to view certificate content, delete, or export your certificates.

You can store up to three CA certificates to use SSL.

We recommend storing one certificate fewer than allowed, reserving an empty spot in case of certificate expiration. When a certificate expires, import a new certificate into the reserved spot, and then delete the expired certificate. This ensures that you avoid configuration failure.



When you use TLS for SMTP communications, you do not have to select a certificate. The necessary certificate is selected automatically.



Related Information

- [Certificates and Web Based Management](#)

Send an Email Securely

Related Models: ADS-2700W

1. Start your web browser.
2. Type "http://machine's IP address" in your browser's address bar (where "machine's IP address" is the machine's IP address).
For example:
http://192.168.1.2
3. By default, no password is required. If you have previously set a password, type it, and then click .
4. Click the **Network** tab.
5. Click the **Protocol** menu in the left navigation bar.
6. In the **SMTP** field, click **Advanced Settings** and make sure the status of **SMTP** is **Enabled**.
7. Configure the **SMTP** settings.
 - Confirm that the email settings are correct after configuration by sending a test email.
 - If you do not know the SMTP server settings, contact your network administrator or Internet Service Provider (ISP).
8. When finished, click **Submit**.
The **Test Send E-mail Configuration** dialog box appears.
9. Follow the instructions in the dialog box to test the current settings.

Sending an Email with User Authentication

Your Brother machine supports the SMTP-AUTH method to send email via an email server that requires user authentication. This method prevents unauthorized users from accessing the email server. You can use Web Based Management to configure these settings. You can use SMTP-AUTH for email notification, email reports and Scan to E-mail Server.

- **Email Client Settings**
 - You must match the SMTP authentication method settings with the method used by your email application.
 - Contact your network administrator or your ISP about the email client configuration.
 - You must select the **SMTP-AUTH** check box of **Server Authentication Method** to enable SMTP server authentication.
- **SMTP settings**
 - You can change the SMTP port number using Web Based Management. This is useful if your ISP (Internet Service Provider) implements the "Outbound Port 25 Blocking (OP25B)" service.
 - By changing the SMTP port number to a specific number that your ISP is using for the SMTP server (for example, port 587), you can send an email via the SMTP server.

Sending an Email Securely Using SSL/TLS

This machine supports TLS to send an email via an email server that requires secure TLS communication. To send email via an email server that is using TLS communication, you must configure TLS correctly.

- **Verifying Server Certificate**

If you selected **SSL/TLS**, the **Verify Server Certificate** check box is automatically selected to verify the Server Certificate.

 - The server certificate is verified during the connection attempt with the server when sending email.
 - If you do not need to verify the Server Certificate, clear the **Verify Server Certificate** check box.
- **Port Number**
 - If you selected **SSL/TLS**, the **Port** value is changed to match the protocol. To change the port number manually, type the port number.

-
- You must configure the SMTP communication method to match the email server. For more information about the email server settings, contact your network administrator or ISP (Internet Service Provider).

In most cases, the secured webmail services require the following settings:

SMTP	Port	587
	Server Authentication Method	SMTP-AUTH
	SSL/TLS	TLS



Related Information

- [Network Security Features](#)
-

Troubleshooting

- [Error and Maintenance Messages](#)
- [Error and Maintenance Indications](#)
- [Document Jam](#)
- [If You Are Having Difficulty with Your Machine](#)
- [Check the Serial Number](#)
- [Reset Your Brother Machine](#)
- [Reset the Usage Counters](#)

Error and Maintenance Messages

Related Models: ADS-2700W

As with any sophisticated office product, errors may occur and supply items must be replaced eventually. If this happens, your machine identifies the error or required routine maintenance and displays the appropriate message. The most common error and maintenance messages are shown in the table below.

You can correct most errors and clear routine maintenance messages yourself. If you need further information, go to your model's **FAQs & Troubleshooting** page on the Brother Solutions Center at support.brother.com.

Error Message	Cause	Action
Access Denied	Secure Function Lock is On.	Contact your administrator to check your Secure Function Lock settings. <i>See Related Information: Secure Function Lock 3.0.</i>
Authentication Error	The password entered in Scan to Network was incorrect.	Enter the correct password. If you forgot it, you must reset it. <i>See Related Information: Set up a Scan to Network Profile.</i>
Check Connection	The machine is not connected to the network.	Check the network connection.
	The computer and machine are not connected using a USB cable.	Connect the USB cable. If a USB flash drive is inserted into the machine, remove it.
Confirm the following and try again. - Check the network connection. - Set the correct Date&Time.	There is a problem with the settings in the machine and/or server.	Make sure your machine is connected to a network with Internet access. Verify that the date and time are set correctly on your machine.
	The computer and machine are not connected using a USB cable.	Connect the USB cable. If a USB flash drive is inserted into the machine, remove it.
Connection Failed	The machine could not connect to the network.	Check the following: <ul style="list-style-type: none"> The PIN is correct. You did not press the WPS button on two or more wireless access point/routers. The wireless access point/router is turned on. Restart the machine and the wireless access point/router.
Document Jam	<ul style="list-style-type: none"> The Paper Guides are not set to the correct document size. The settings are not appropriate for your document. Paper dust has accumulated on the surface of the Pick Up Roller or Brake Roller. 	Clear the document jam, and then do the following: <ul style="list-style-type: none"> Adjust the Paper Guides to fit the width of the document. When Scan Size is set to Auto and you are scanning a document that contains multiple page sizes, insert narrow pages straight and as close to the center of the machine as possible. If the document does not feed straight, use the continuous scan option. Confirm the settings. <i>See Related Information: Document Jam.</i>

Error Message	Cause	Action
		<ul style="list-style-type: none"> Clean the Pick Up Roller and Brake Roller. <p>See <i>Related Information: Clean the Scanner and Rollers.</i></p>
Incorrect PIN	The PIN Number entered in Secure Function Lock was incorrect.	<p>Enter the correct PIN Number. Contact your administrator to check your Secure Function Lock settings.</p> <p>See <i>Related Information: Secure Function Lock 3.0.</i></p>
Insufficient USB Storage	The inserted USB flash drive is full.	<p>Press Close, and then do one of the following:</p> <ul style="list-style-type: none"> Delete unused files or folders from the USB flash drive, and then try again. Use a USB flash drive that has more free space.
No Access Point:	The machine cannot detect a wireless access point/router that has an active WPS function.	<p>Check the following:</p> <ul style="list-style-type: none"> You did not press the WPS button on two or more wireless access point/routers. Restart the machine and the wireless access point/router.
No Certificate	The certificate does not exist, or is corrupted.	<p>Configure the settings under Signed PDF in the Administrator tab in Web Based Management.</p> <p>See <i>Related Information: Upload Scanned Data to an FTP Server.</i></p> <p>See <i>Related Information: Upload Scanned Data to a Mapped Network Drive (CIFS) Server.</i></p>
No PC found	The machine is not connected to your computer.	Connect the machine to your computer, and then try again.
No Profile found	No Scan to FTP/SFTP profile or Scan to Network profile is registered.	<p>Configure the Scan to FTP/SFTP profile or the Scan to Network profile before using Scan to FTP or Scan to Network.</p> <p>See <i>Related Information: Set up a Scan to FTP Profile.</i></p> <p>See <i>Related Information: Set up a Scan to SFTP Profile.</i></p> <p>See <i>Related Information: Set up a Scan to Network Profile.</i></p>
Not Registered	(Scan) The email address or SMTP server address of the scan destination is not registered.	Make sure the email address or SMTP server address is correctly configured.
	(Secure Function Lock) A user not registered in Secure Function Lock is accessing the machine.	<p>Contact your administrator to check your Secure Function Lock settings.</p> <p>See <i>Related Information: Secure Function Lock 3.0.</i></p>
Remove documents.	Auto Start Scan Mode was enabled while a document was loaded.	Remove the document, and then reload it.
Replace Pickup Roller	All Rollers have been used over 100,000 times.	Replace all rollers with new ones. Scanning errors may occur if you do not replace the part.

Error Message	Cause	Action
		See <i>Related Information: Replace the Pick Up Roller</i> . See <i>Related Information: Replace the Brake Roller</i> .
Scheduled Maintenance Alert	The Pick Up Roller has been used over 5,000 times.	Clean the Brake Roller and Pick Up Roller. Paper jams and reduced scan quality issues may occur if you do not clean them. See <i>Related Information: Clean the Scanner and Rollers</i> .
Sending Error	The Scan to FTP/SFTP profile, Scan to Network profile or Scan to E-mail Server is not configured correctly.	Make sure the Scan to FTP/SFTP profile, Scan to Network profile or Scan to E-mail Server is configured correctly. Configure the Network Settings.
Server Time out	The machine was disconnected from the Scan to FTP/SFTP profile, Scan to Network profile or Scan to E-mail Server.	Make sure the Scan to FTP/SFTP profile, Scan to Network profile or Scan to E-mail Server is configured correctly. Configure the Network Settings.
Setting Lock	Adding a new shortcut was attempted while the Setting Lock was turned on.	Disable the Setting Lock.
Unsupported security information (Authentication method/Encryption method). Confirm supported security mode and try again.	The security settings is incorrect.	Confirm the security settings and try again.
Unusable Device	An unusable device is inserted in the USB port.	Remove the device. Turn the machine off and on by unplugging the machine from the AC power outlet, and then plugging the machine in again.
USB Access Error	The USB flash drive was removed while it was being accessed.	Insert the USB flash drive.
USB Hub Not Supported	A USB flash drive with a hub is inserted in the USB port.	Remove the unsupported device from the USB port.
USB Write-protected	The inserted USB flash drive is write-protected.	Remove the write-protected USB flash drive, press Close , and then do one of the following: <ul style="list-style-type: none"> • Turn off the USB flash drive's write-protection, and then try again. • Use a USB flash drive that is not write-protected.
Wrong Network Key	The Network Key is incorrect.	Confirm the Network Key and try again.
Wrong Password	The password entered in Setting Lock was incorrect.	Enter the correct password. If you forgot it, you must reset it. See <i>Related Information: Set or Change the Setting Lock Password</i> .









Related Information







- [Troubleshooting](#)
- [Secure Function Lock 3.0](#)
- [Clean the Scanner and Rollers](#)
- [Replace the Pick Up Roller](#)



-
- Replace the Brake Roller
 - Set up a Scan to Network Profile
 - Upload Scanned Data to an FTP Server
 - Upload Scanned Data to a Mapped Network Drive (CIFS) Server
 - Set up a Scan to FTP Profile
 - Set up a Scan to SFTP Profile
 - Set or Change the Setting Lock Password
 - Document Jam
-

Error and Maintenance Indications

The LED indications on the control panel are explained in this table.

Error Indicator	Power Indicator	Description
		The LED is off.
		The LED is on.
		The LED is blinking.

Error Indicator	Power Indicator	Machine Status
		Document Jam Clear the document jam. If scanning a long document, select Long paper from the Scan Size or Document Size drop-down list.
		Pick Up Document Error The machine cannot pick up the document. Open the Front Cover and remove the document. Close the Front Cover and reload your document.
		Multifeed Detection Error A multifeed has occurred. Clear the multifeed.
		Front Cover Open The Front Cover is open.
		Access Error <ul style="list-style-type: none"> • Scan to PC The USB cable is not connected to the machine. Connect the USB cable. • Scan to USB <ul style="list-style-type: none"> - A USB flash drive is not inserted into the machine. Insert a USB flash drive. - The USB flash drive was removed while it was being accessed. Reinsert the USB flash drive.
		Unusable Device An unsupported USB device is inserted in the USB port. Remove the device.
		Updating the Firmware Firmware update in progress. Wait for the update to complete.
		The Pick Up Roller has been used more than 100,000 times. Confirm the remaining life in the Machine Info dialog box using Remote Setup. If the Pick Up Roller or Brake Roller have been exceeded their usage limit, replace them and then reset the Roller Counter using Remote Setup. See <i>Related Information:Reset the Usage Counters</i> .
		The Pick Up Roller has been used more than 100,000 times. Confirm the remaining life in the Machine Info dialog box using Remote Setup. If the Pick Up Roller or Brake Roller have been exceeded their usage limit, replace them and then reset the Roller Counter using Remote Setup. See <i>Related Information:Reset the Usage Counters</i> .

Error Indicator	Power Indicator	Machine Status
		<p>The Scheduled Maintenance counter has exceeded 5,000.</p> <p>Confirm the remaining life in the Machine Info dialog box using Remote Setup.</p> <p>If the Scheduled Maintenance counter has exceeded the limit, clean the machine promptly. If you do not, document jams and paper feed problems may occur. After cleaning the machine, reset the Scheduled Maintenance Counter using Remote Setup. See <i>Related Information: Clean the Scanner and Rollers</i></p>





Related Information

- [Troubleshooting](#)
- [Service Call Indications](#)
- [Document Jam](#)
- [Reset the Usage Counters](#)
- [Clean the Scanner and Rollers](#)
- [Replace the Pick Up Roller](#)
- [Replace the Brake Roller](#)

Service Call Indications

If there is an error that you cannot clear yourself, the machine will indicate the need for a service call by lighting up the Power Indicator and blinking the Error Indicator as shown.

Error Indicator	Power Indicator
	

If you see the service call indication shown, contact your Brother dealer or Brother Customer Service.



Related Information

- [Error and Maintenance Indications](#)

Document Jam

Documents can jam in the ADF unit if they are not inserted or fed correctly, if they are too long, or if multiple pages are fed at the same time (multifeed).

1. Remove any paper from the ADF that is not jammed.
2. Open the Front Cover by pressing the Cover Release Tab (1).

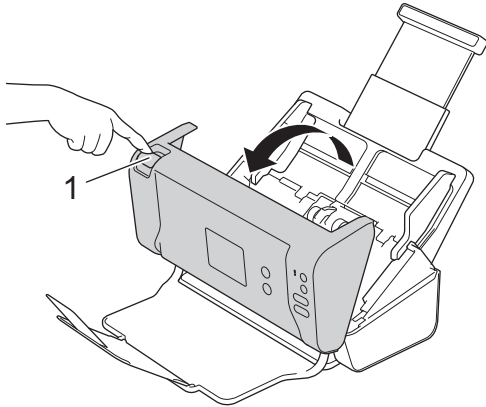

3. Pull the jammed document out of the machine.

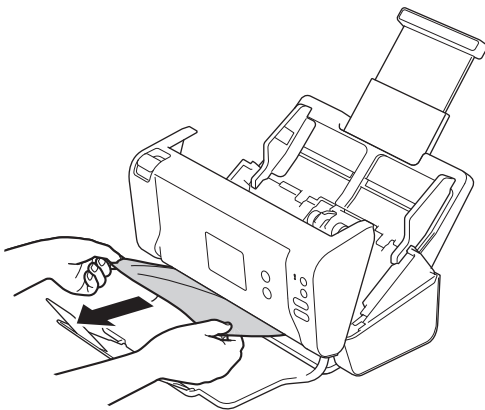

 Check for ripped paper inside the machine. Remove any paper scraps you find inside the machine.

4. Close the Front Cover.
5. Press any button. (ADS-2200) Or press . (ADS-2700W)

 When clearing the multifeed, confirm that the data scanned before the multifeed was detected has been saved, and then start scanning again from the next page or the beginning of the document.

IMPORTANT

- To avoid damage to the jammed document, DO NOT pull the document out before opening the Front Cover.
- Take out any paper from the ADF before closing the Front Cover.
- To avoid future document jams, do the following:
 - Close the Front Cover correctly by pushing it gently in the center.
 - Configure the settings for your document correctly.
 - Fan the paper to help prevent document jams and multi-feeding documents.

-
- Clean the Brake Roller and Pick Up Roller. See *Related Information: Clean the Scanner and Rollers*.
 - Stagger the pages and then load your document.
 - Make sure your document is acceptable for the machine.
 - Load your document correctly.
 - Load no more than 50 pages at a time.
 - When using long paper, to avoid a paper jam, you must select the **Long paper** option from the **Document Size** menu.
-



Related Information

- [Troubleshooting](#)
 - [Error and Maintenance Indications](#)
 - [Clean the Scanner and Rollers](#)
 - [Acceptable Documents](#)
 - [Load Documents](#)
-

If You Are Having Difficulty with Your Machine

You can correct most problems yourself. If you think there is a problem with your machine, check the topics below. If you need additional help, the Brother Solutions Center offers the latest **FAQs & Troubleshooting** tips at support.brother.com.



Using non-Brother supplies may affect the scan quality, hardware performance, and machine reliability.

- [Scanning and Other Problems](#)
- [Network Problems](#)

Scanning and Other Problems

Scanning Difficulties



Difficulties	Cause	Suggestions
<p>TWAIN or WIA errors appear when starting to scan. (Windows®)</p>	<p>The TWAIN or WIA driver has not been selected as the primary source in your scanning application.</p>	<p>Make sure the Brother TWAIN or WIA driver is selected as the primary source in your scanning application. For example, in Nuance™ PaperPort™ 14SE, click Scan Settings > Select. Select the Brother TWAIN/WIA driver.</p>
<p>TWAIN errors appear when starting to scan. (Mac)</p>	<p>The TWAIN driver has not been selected as the primary source in your scanning application.</p>	<p>Make sure the Brother TWAIN driver is selected as the primary source in your application.</p> <p>You can also scan documents using the ICA Scanner Driver.</p>
<p>Vertical lines are seen in the scanned image.</p>	<p>Paper dust has accumulated on the surface of the glass strips.</p>	<p>Clean the glass strips inside the machine.</p> <p>See <i>Related Information: Clean the Scanner and Rollers</i>.</p>
<p>The scanned image is missing.</p>	<p>The Paper Guides are not adjusted to fit the width of the document.</p>	<p>Adjust the Paper Guides to fit the width of the document. When Scan Size is set to Auto and you are scanning a document that contains multiple page sizes, insert narrow pages straight and as close to the center of the machine as possible. If the document does not feed straight, use the continuous scan option.</p>
	<p>The settings are not appropriate for your document. For example, a Letter/A4-sized document was fed when Executive/A5 Letter was selected as the document size.</p>	<p>Make sure the document size settings are appropriate for your document.</p> <p>Configure the margin settings and adjust the scanning position.</p>
	<p>If you use a preset document size, the document skewing cannot be corrected automatically.</p>	<p>Select Auto for <code>Document Size</code>.</p>
	<p>-</p>	<p>Configure the margin settings and adjust the scanning position.</p>
<p>The scanned image is skewed.</p>	<p>The Paper Guides are not adjusted to fit the width of the document.</p>	<p>Adjust the Paper Guides to fit the width of the document. When Scan Size is set to Auto and you are scanning a document that contains multiple page sizes, insert narrow pages straight and as close to the center of the machine as possible. If the document does not feed straight, use the continuous scan option.</p>
	<p>The Long Paper setting is selected.</p>	<p>Select a setting other than Long Paper.</p>
<p>Scanning is too slow.</p>	<p>The resolution is not appropriate for your document.</p>	<p>Decrease the scanner resolution.</p>

Difficulties	Cause	Suggestions
The document was not fed.	Paper dust has accumulated on the surface of the Pick Up Roller or Brake Roller.	Clean the Brake Roller and Pick Up Roller. See <i>Related Information: Clean the Scanner and Rollers</i> .
	Too many documents are loaded in the ADF at a time.	Make sure the maximum number of pages is appropriate for your document. See <i>Related Information: Acceptable Documents</i> .
	There are foreign objects in the ADF.	Remove any foreign objects or ripped paper from the ADF.
	Your media is too thin or too thick.	Make sure your media is acceptable for the machine. See <i>Related Information: Acceptable Documents</i> .
	Remote Setup is in process.	Cancel Remote Setup.
	Paper ejection has paused.	Remove any paper from the ADF.
The document is jammed.	Paper dust has accumulated on the surface of the Pick Up Roller or Brake Roller.	Clean the Brake Roller and Pick Up Roller. See <i>Related Information: Clean the Scanner and Rollers</i> .
	There are foreign objects in the ADF.	Remove any foreign objects or ripped paper from the ADF.
	Your document is not acceptable for the machine.	Make sure your document is acceptable for the machine. See <i>Related Information: Acceptable Documents</i> .
The scan quality is poor.	Paper dust has accumulated on the surface of the Pick Up Roller or Brake Roller.	Clean the Brake Roller and Pick Up Roller. See <i>Related Information: Clean the Scanner and Rollers</i> .
	Paper dust has accumulated on the surface of the glass strips inside the machine.	Clean the glass strips inside the machine. See <i>Related Information: Clean the Scanner and Rollers</i> .
	The scanner resolution is too low.	Increase the scanner resolution.
Bleedthrough is seen in the scanned data.	The settings are not appropriate for the type of document being scanned.	Select the Remove Bleed-through / Pattern / Remove Background Color check box.
Colors in the scanned data are dark.	The settings are not appropriate for the type of document being scanned.	Do one of the following: <ul style="list-style-type: none"> Select the Remove Bleed-through / Pattern / Remove Background Color check box, and then scan from your computer. Increase the Brightness, and then scan from your computer. Increase the Contrast, and then scan from your computer. Change the Scan Type to Gray or Color, and then scan from your computer.
A page that is not a blank page is skipped.	<ul style="list-style-type: none"> The document is too light. Skip Blank Page is set to On. 	Set Skip Blank Page to Off. Alternatively, reduce the Skip Blank Page sensitivity.
Cannot scan a long document.	Long Paper is not selected for the document size.	Select Long Paper for the document size. If you cannot select Long Paper, when scanning from the machine's Control Panel, set Skip Blank Page to Off, set 2-sided Scan to Off and set Scan Type to an option other than Auto. Then, you can select Long Paper for the document size.
A multifeed occurs.	The document is not loaded correctly.	Load your document correctly, and then try again.

Difficulties	Cause	Suggestions
Cannot scan.	Secure Function Lock is on.	Contact your administrator to check your Secure Function Lock settings. <i>See Related Information: Secure Function Lock 3.0.</i>
	The Pull Scan option in the Scan from PC dialog box in Web Based Management is disabled.	Enable the Pull Scan option.
Cannot scan to a computer from the machine.	The WIA service is not started. (Windows®) Brother PushScan is not set.	Start the WIA service. (Windows®) Set Brother PushScan so that it starts.
Scanning does not start even if I press the Scan Button on the right side of the machine. (ADS-2700W)	The settings for the first shortcut are incorrect.	Confirm the settings for the first shortcut.
Auto Start Scan does not start. (ADS-2700W)	The settings for Auto Start Scan (Shortcut 21) are incorrect.	Confirm the settings for Auto Start Scan (Shortcut 21).

Software Difficulties

Difficulties	Cause	Suggestions
Cannot save the settings in Remote Setup or Web Based Management.	The machine is processing.	Wait until the machine finishes processing, and then try again.
	The machine is being configured from the machine's Control Panel.	Stop configuring the machine from the Control Panel and use Remote Setup or Web Based Management instead.
Cannot start Remote Setup.	The machine is turned off.	Turn on the machine, and then try again.
	The machine is not connected to your computer.	Connect the machine to your computer, and then try again.
	An error is occurring.	Clear all errors, check the status is Ready on Remote Setup and then try again.
	The machine is scanning.	Wait until scanning has finished and try again.
	The machine is being configured from the machine's Control Panel.	Stop configuring the machine from the Control Panel.
	Because you pressed the  button on the machine before saving the Remote Setup settings, the machine went into Sleep Mode.	Access Remote Setup again and save the settings.
	A USB flash drive is inserted into the machine.	Remove the USB flash drive.

Difficulties	Cause	Suggestions
The machine is in Sleep Mode (power save mode).	The machine is idle and the amount of time specified by the Sleep Mode setting has elapsed.	Do one of the following: <ul style="list-style-type: none"> • Press . • Press . (ADS-2700W) • Scan using your computer. • Open the Top Cover. • Load your document. • Touch the screen. (ADS-2700W) • Insert/disconnect the USB flash drive. • Insert/disconnect the USB cable from the machine or PC.
The machine is not turned on.	The machine was plugged in within 60 seconds after pulling out the plug.	Turn off the machine, wait 60 seconds, and then turn it on again
Your computer cannot find the machine via USB interface.	A USB flash drive is inserted.	Remove the USB flash drive.
	The scanner driver is not installed.	Install the scanner driver.
Cannot enter the IP address and Subnet Mask. (ADS-2700W)	"000.000.000.000." has already been entered.	Press the  button to delete the entered information, and then enter the correct information.
The computer has detected a USB flash drive.	A USB flash drive is inserted into the machine and the computer is connected to the machine using a USB cable.	The computer detects the USB flash drive that is inserted into the machine. Remove the USB flash drive so that the computer does not detect it.
Although scanning is allowed by the Secure Function Lock, the Scan Button on the right side of the machine is not available. (ADS-2700W)	The Scan Button on the machine is not available when the Secure Function Lock is turned on.	Turn off the Secure Function Lock.
I want to restrict to change setting from Remote Setup.	-	When you set SFL or Setting Lock is on, Remote Setup can't start by any user.
I want to prevent users from changing settings using Remote Setup. (ADS-2700W)	-	When you turn on the Secure Function Lock or Setting Lock, the users cannot use Remote Setup.



Related Information

- [If You Are Having Difficulty with Your Machine](#)
- [Clean the Scanner and Rollers](#)
- [Secure Function Lock 3.0](#)
- [Acceptable Documents](#)

Network Problems

- [If You Cannot Complete the Wireless Network Setup Configuration](#)
- [Your Scanner Cannot Be Detected on the Network During Installation](#)
- [Your Brother Machine Cannot Scan over the Network](#)
- [If You Want to Check that Your Network Devices are Working Correctly](#)

If You Cannot Complete the Wireless Network Setup Configuration

Related Models: ADS-2700W

Turn your wireless router off and back on. If that does not resolve the problem, try to configure the wireless settings again. If this still does not resolve the problem, use the Actions listed in this table.

Cause	Action	Interface
Your security settings (SSID/ Network Key (Password)) are not correct.	<p>Confirm your security settings.</p> <ul style="list-style-type: none"> The manufacturer's name or model number of the wireless access point/router may be used as the default security settings. See the instructions supplied with your wireless access point/router for information on how to find the security settings. Ask the manufacturer of your wireless access point/router, your Internet provider, or your network administrator. 	Wireless
Your Brother machine's MAC address is not allowed.	Confirm that the Brother machine's MAC Address is allowed in the filter. You can find the MAC address using the Brother machine's control panel.	Wireless
Your wireless access point/router is in stealth mode (not broadcasting the SSID).	<ul style="list-style-type: none"> Enter the correct Network Name (SSID) and Network Key (Password) manually. Check the Network Name (SSID) and Network Key (Password) in the instructions supplied with your wireless access point/router and reconfigure the wireless network setup. 	Wireless
Your security settings (SSID/ Password) are not correct.	<p>Confirm the Network Name (SSID) and Network Key (Password). When you are configuring the network manually, the SSID and password are displayed on your Brother machine. If your mobile device supports the manual configuration, the SSID and password will be displayed on your mobile device's screen.</p>	Wi-Fi Direct
Your Brother machine is placed too far from your mobile device.	Move your Brother machine within about 3.3 feet (1 meter) of the mobile device when you configure the Wi-Fi Direct network settings.	Wi-Fi Direct
There are some obstructions (walls or furniture, for example) between your machine and the mobile device.	Move your Brother machine to an obstruction-free area.	Wi-Fi Direct
There is a wireless computer, Bluetooth-supported device, microwave oven, or digital cordless phone near the Brother machine or the mobile device.	Move other devices away from the Brother machine or the mobile device.	Wi-Fi Direct
If you have checked and tried all of the actions, but still cannot complete the Wi-Fi Direct configuration.	Turn your Brother machine off and back on. Then try to configure the Wi-Fi Direct settings again.	Wi-Fi Direct
Your machine is in Sleep Mode and cannot configure the network settings on Web Based Management.	Turn off the Sleep Mode.	Wireless
The enterprise wireless network is not configured correctly.	Configure the settings in Web Based Management.	Wireless





Related Information

- [Network Problems](#)
-

Your Scanner Cannot Be Detected on the Network During Installation

Related Models: ADS-2700W

Cause	Action	Interface
Your computer is not connected to the network.	Make sure your computer is connected to a network, for example, a LAN environment or Internet services. For further support, contact your network administrator.	Wired/Wireless
Your machine is not connected to the network.	<p>(Wired network)</p> <p>Press  Settings > Network > Wired LAN > Wired Status > Status. If the LCD displays <i>Auto</i> or <i>Off</i>, ask your network administrator whether your IP address is valid or not.</p> <p>(Wireless network)</p> <p>Press  Settings > Network > WLAN > WLAN Status > Status. If the LCD displays <i>Connection Failed:</i>, ask your network administrator whether your IP address is valid or not.</p>	Wired/Wireless
You use security software.	<ul style="list-style-type: none"> In the installer dialog box, search for the Brother machine again. Allow access when the alert message of the security software appears during the Brother Device installation. The following port numbers are used for Brother network features: <ul style="list-style-type: none"> Network scanning, Remote Setup Port number 5566/Protocol TCP Network scanning (Brother iPrint&Scan) Port number 54921/Protocol TCP BRAdmin Light Port number 161/Protocol UDP For more information about security software, see <i>Related Information: Your Brother Machine Cannot Scan over the Network</i> 	Wired/Wireless
You use a Wi-Fi router.	The privacy separator on your Wi-Fi router may be enabled. Disable the privacy separator.	Wireless
Your Brother machine is placed too far from the Wireless access point/router.	Place your Brother machine within about 3.3 feet (1 meter) of the Wireless access point/router when you configure the wireless network settings.	Wireless
There are some obstructions (walls or furniture, for example) between your machine and the Wireless access point/router.	Move your Brother machine to an obstruction-free area, or closer to the Wireless access point/router.	Wireless
There is a wireless computer, Bluetooth-supported device, microwave oven, or digital cordless phone near the Brother machine or the Wireless access point/router.	Move all the devices away from the Brother machine or Wireless access point/router.	Wireless



Related Information

- [Network Problems](#)

-
- Your Brother Machine Cannot Scan over the Network
 - If You Want to Check that Your Network Devices are Working Correctly
-

Your Brother Machine Cannot Scan over the Network

Related Models: ADS-2700W

Cause	Action	Interface
You did not select Accept in the security alert dialog box during the Brother Device installation, applications' start-up process, or when using the scanning features.	If you did not select Accept in the security alert dialog box, the firewall function of your security software may be denying access. Some security software may block access without showing a security alert dialog box. To allow access, see your security software instructions or ask the manufacturer.	Wired/Wireless
Your security software blocks your machine's access to the network. (The Network scanning feature does not work.)	<ul style="list-style-type: none"> • Windows® Configure the third-party Security/Firewall Software to allow Network scanning. To add port 52515-52614 for Network scanning, enter the information below: <ul style="list-style-type: none"> - Name Type any description, for example Brother NetScan. - Port number Type 54925. - Protocol Both TCP and UDP are selected. See the instruction manual that came with your third-party Security/Firewall Software or contact the software manufacturer. • Mac Reinstall the driver. 	Wired/Wireless
Your security software blocks your machine's access to the network.	The following port numbers are used for Brother network features: <ul style="list-style-type: none"> • Network scanning, Remote Setup Port number 5566/Protocol TCP • Network scanning (Brother iPrint&Scan) Port number 54921/Protocol TCP • BRAdmin Light Port number 161/Protocol UDP For information about how to open the port, see the security software instructions or ask the manufacturer.	Wired/Wireless
Your Brother machine was not assigned an available IP address.	Confirm the IP address and the Subnet Mask. Verify that both the IP addresses and Subnet Masks of your computer and the Brother machine are correct and located on the same network. For more information about how to verify the IP address and the Subnet Mask, ask your network administrator.	Wired/Wireless
You cannot connect the Brother machine to the network using wireless capabilities.	Press  Settings > Network > WLAN > WLAN Status > Status. If the LCD displays Connection Failed:, ask your network administrator whether your IP address is valid or not.	Wireless
Because the machine does not support SMB 2.0, Kerberos authentication, or DFS, Network scanning cannot be used.	Change the server settings or change the destination folder where your document will be stored in the Scan to Network Profile from Web Based Management.	Wired/Wireless

If you have checked and tried all of the actions, but your Brother machine still cannot scan, uninstall the Brother software and drivers and reinstall them.





Related Information

- [Network Problems](#)
 - [Your Scanner Cannot Be Detected on the Network During Installation](#)
 - [If You Want to Check that Your Network Devices are Working Correctly](#)
-

If You Want to Check that Your Network Devices are Working Correctly

Related Models: ADS-2700W

Check	Action	Interface
Check that your Brother machine, access point/router, or network hub is turned on.	<p>Check the following:</p> <ul style="list-style-type: none"> The power cord is connected correctly and the Brother machine is turned on. The access point/router or hub is turned on and its link button is blinking. All protective packaging has been removed from the machine. The Front Cover, Separation Pad Cover and Pick-up Roller Cover are completely closed. 	Wired/Wireless
Check your Brother machine's network settings, such as IP address, or the link status.	<ul style="list-style-type: none"> For Web Based Management Start Web Based Management and access your Brother machine. When the Web Based Management screen appears, click the Network tab, and then click Network Status in the left navigation bar. For Control panel <ul style="list-style-type: none"> (Wired network) Press  Settings > Network > Wired LAN > Wired Status > Status. If the LCD displays Auto or Off, ask your network administrator whether your IP address is valid or not. (Wireless network) Press  Settings > Network > WLAN > WLAN Status > Status. If the LCD displays Connection Failed:, ask your network administrator whether your IP address is valid or not. 	Wired/Wireless
Check that you can "ping" the Brother machine from your computer.	<p>Ping the Brother machine from your computer using the IP address or the node name in the Windows® command prompt or Mac Terminal application: ping <ipaddress> or <nodename>.</p> <ul style="list-style-type: none"> Successful: Your Brother machine is working correctly and connected to the same network as your computer. Unsuccessful: Your Brother machine is not connected to the same network as your computer. Confirm that the IP address and the Subnet Mask are set correctly. 	Wired/Wireless

If you have checked and tried all of the actions but you are still having problems, see the instructions supplied with your wireless access point/router to find the SSID and the Network Key (Password) information and set them correctly.



Related Information

- [Network Problems](#)
- [Your Brother Machine Cannot Scan over the Network](#)
- [Your Scanner Cannot Be Detected on the Network During Installation](#)

Check the Serial Number

- >> ADS-2200
- >> ADS-2700W

ADS-2200

- Do one of the following:
 - Windows®
Click  (Start) > All Programs > Brother > ADS-XXXXX > Remote Setup.
 - Mac
In the **Finder** menu bar, click **Go** > **Applications** > **Brother**, and then double-click the **Remote Setup** icon.
- Select your model name in the Discover Devices dialog box, and then click **Connect**.
The Remote Setup Program window appears.
- Click the **Machine Info** menu in the left navigation pane.
The window displays the **Serial No.** (the example below uses Windows®).

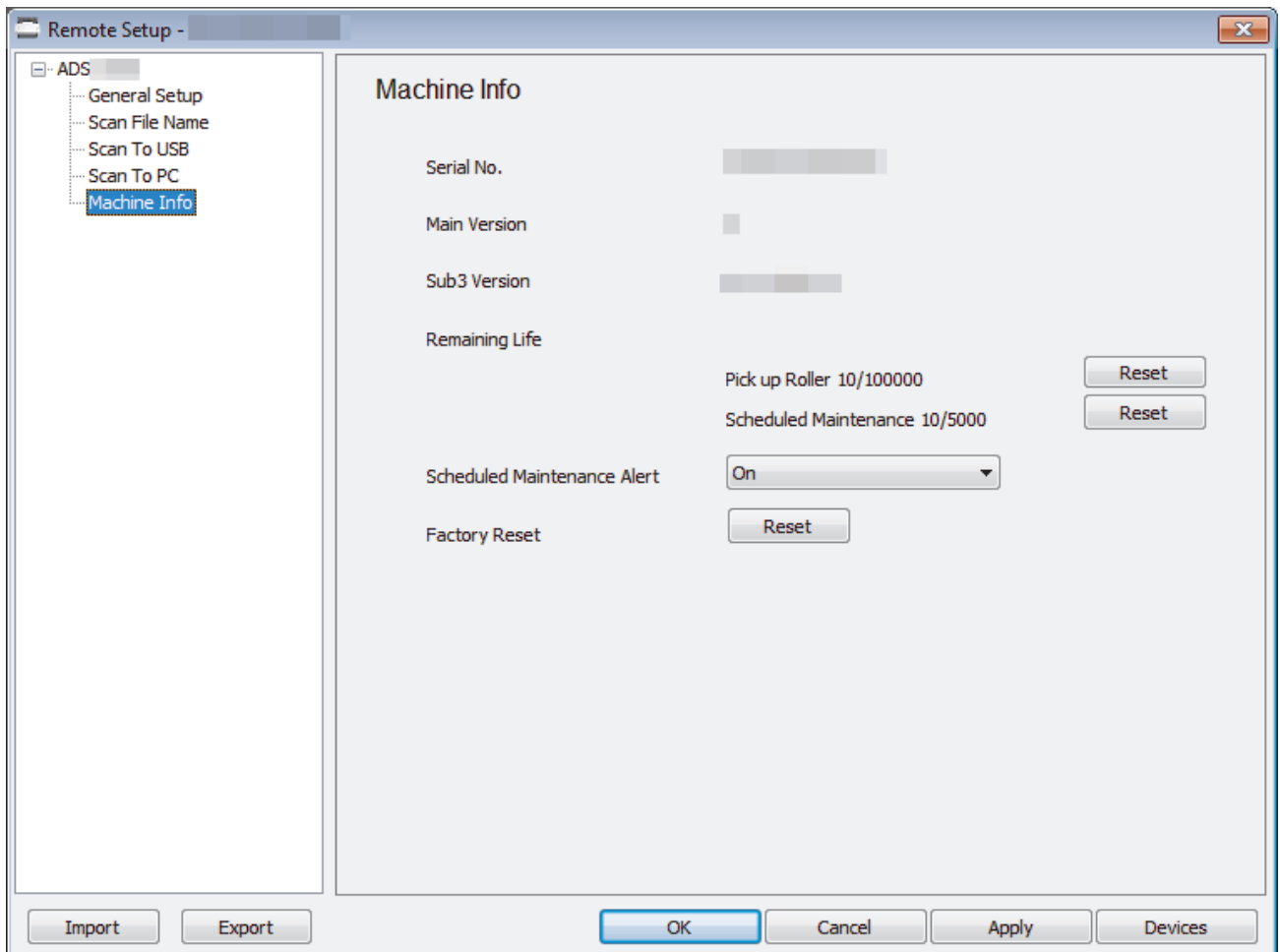

ADS-2700W

- Press  [Settings] > [Machine Info.] > [Serial No.].
The touchscreen displays [Serial No.].



Related Information

- [Troubleshooting](#)

Reset Your Brother Machine

The following reset functions are available:

- Network (ADS-2700W)
Use Network reset if you want to restore the network settings, such as the password and IP address information, to the default factory settings.
- Address Book (ADS-2700W)
You can reset the Address Book and delete all existing contact information.
- All Settings
Use All Settings reset to restore all settings originally set at the factory. We recommend performing this procedure before transferring or disposing of the machine.



Unplug the interface cable before you perform a Network or All Settings reset.

>> [ADS-2200](#)

>> [ADS-2700W](#)

ADS-2200

1. Do one of the following:
 - Windows®
Click  (**Start**) > **All Programs** > **Brother** > **ADS-XXXXX** > **Remote Setup**.
 - Mac
In the **Finder** menu bar, click **Go** > **Applications** > **Brother**, and then double-click the **Remote Setup** icon.
2. Select your model name in the Discover Devices dialog box, and then click **Connect**.
The Remote Setup Program window appears.
3. Click the **Machine Info** menu in the left navigation pane.
4. Click the **Reset** button in **Factory Reset**.
5. Click **OK** to close the Remote Setup window.

ADS-2700W

1. Press  [Settings] > [Initial Setup] > [Reset].
2. Press the reset option you want to use.
3. Press [OK] for two seconds to restart the machine.



Related Information

- [Troubleshooting](#)

Reset the Usage Counters

After replacing any machine parts, reset the usage counter so that you can start counting from 0.

>> [ADS-2200](#)

>> [ADS-2700W](#)

ADS-2200

1. Do one of the following:

- Windows®

Click  (**Start**) > **All Programs** > **Brother** > **ADS-XXXXX** > **Remote Setup**.

- Mac

In the **Finder** menu bar, click **Go** > **Applications** > **Brother**, and then double-click the **Remote Setup** icon.

2. Select your model name in the Discover Devices dialog box, and then click **Connect**.

The Remote Setup Program window appears.

3. Click the **Machine Info** menu in the left navigation pane.

4. In the **Remaining Life** section, under **Pickup Roller**, click the **Reset** button.

5. Click **OK** to close the Remote Setup window.

ADS-2700W

1. Press  [Settings] > [Machine Info.] > [Usage Counters].

2. To reset the Roller Counter, press [Roller Count].

3. When the touchscreen displays a confirmation message, press [Yes].

4. Press .

✓ Related Information

- [Troubleshooting](#)
- [Error and Maintenance Indications](#)

Routine Maintenance

- [Clean Your Brother Machine](#)
- [Replace Supplies](#)
- [Pack and Ship Your Brother Machine](#)

Clean Your Brother Machine

- [Clean the Outside of the Machine](#)
- [Clean the Scanner and Rollers](#)

Clean the Outside of the Machine

1. Turn off and unplug the machine from the AC power outlet.
2. Wipe the Control Panel with a dry, soft, lint-free cloth to remove dust.

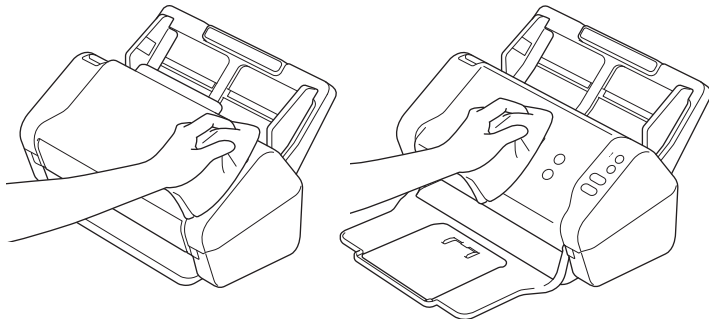

3. Open the Output Tray.

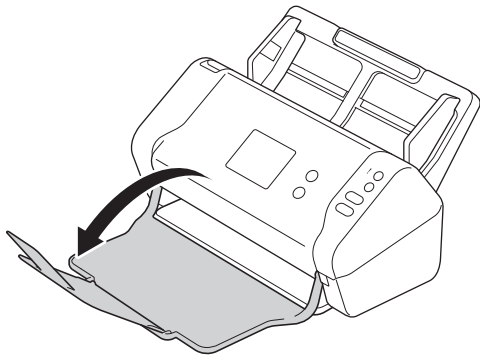

4. Wipe the inside of the Output Tray with a dry, soft, lint-free cloth to remove dust.

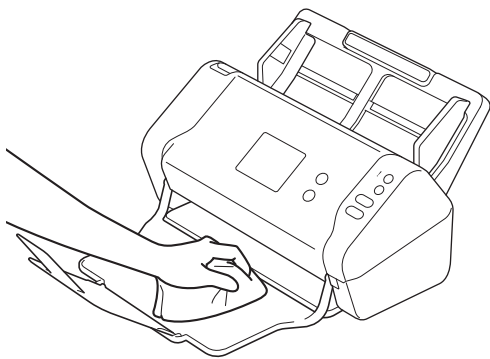

5. Close the Output Tray.

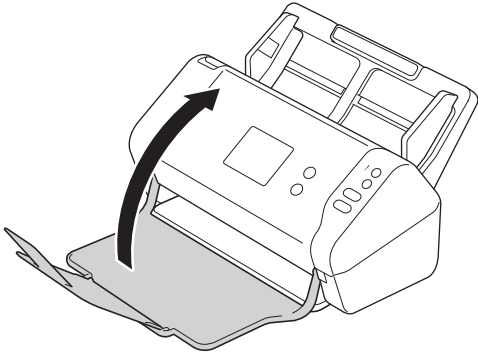

Related Information

- [Clean Your Brother Machine](#)

Clean the Scanner and Rollers

A spot of dirt or correction fluid on the glass strip may cause poor quality scans. Clean the scanner and rollers if a vertical line appears in the scanned data or if areas are missing in the scanned data.

1. Turn off and unplug the machine from the AC power outlet.
2. Remove the ADF (1).

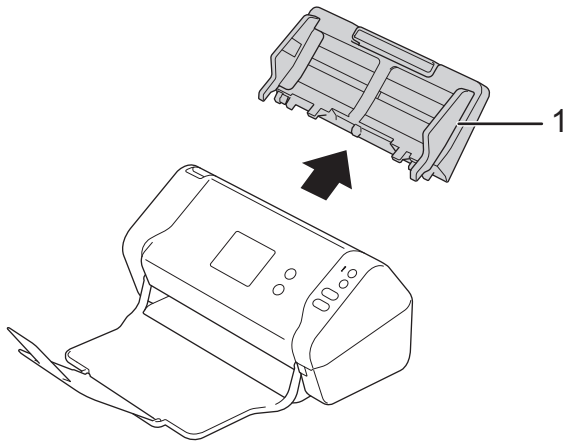

3. Press the release tab to open the Front Cover (1).

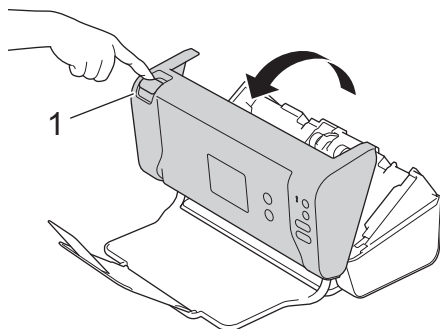

4. From the back of the machine, clean the glass strips in the ADF unit (1) with a soft lint-free cloth.

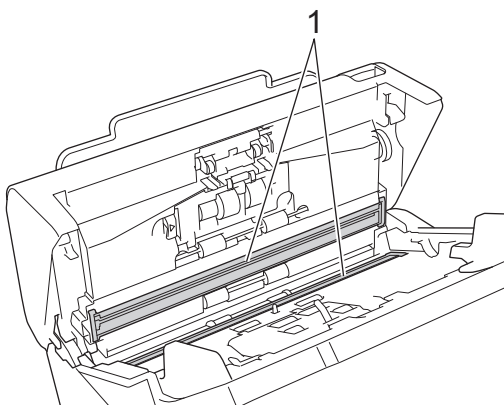

5. While pushing the left side of the Brake Roller Cover (1), pull the cover down.

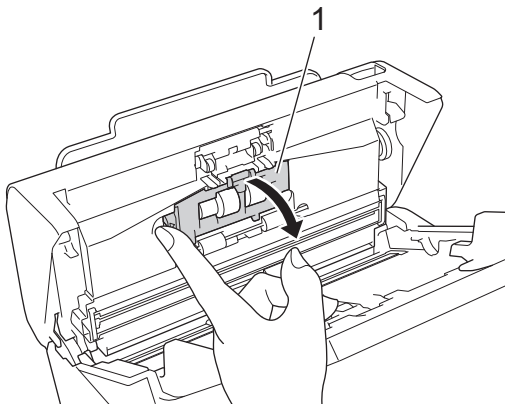

6. Lift the shaft of the Brake Roller (1) with your finger to remove the roller.

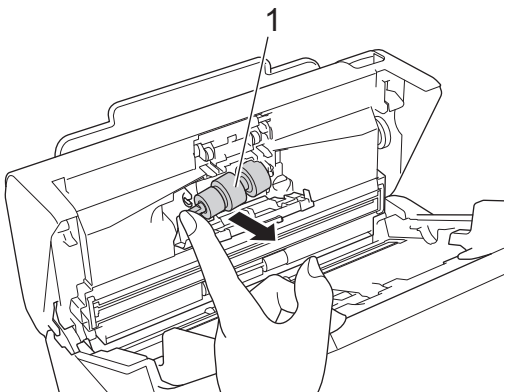

7. Clean the Brake Roller with a soft, lint-free cloth slightly moistened with water.

8. Fit the shaft of the Brake Roller (1) into the slot in the opening and insert the Brake Roller into the machine.

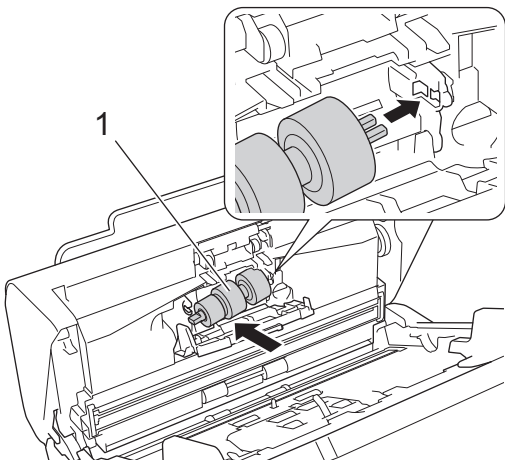

9. Close the Brake Roller Cover.

10. Clean the Pick Up Rollers from side to side with a soft, lint-free cloth slightly moistened with water.

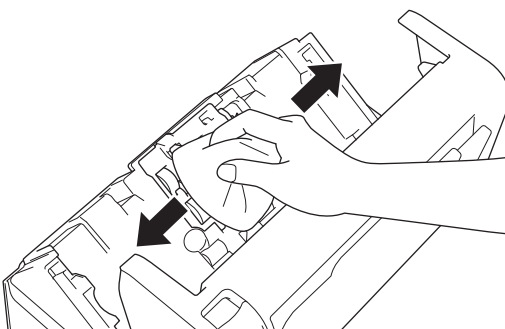

11. Close the Front Cover and attach the ADF.

NOTE

(ADS-2700W)

When [Scheduled Maintenance Alert] appears on the machine's LCD, you must clean the machine promptly. If you do not, document jams and paper feed problems may occur.

First, run your fingertip over the glass to see if you feel anything (dirt or debris). Clean the glass strips with a lint-free cloth. You may have to repeat the cleaning process three or four times. To test, scan a document after each cleaning attempt.



When there is a spot of dirt or correction fluid on the glass strip, the scanned sample shows a vertical line.



After the glass strip is cleaned, the vertical line is gone.



Related Information

- [Clean Your Brother Machine](#)
 - [Error and Maintenance Indications](#)
 - [Document Jam](#)
 - [Scanning and Other Problems](#)
-

Replace Supplies

- [Supplies](#)
- [Check Supplies Replacement Cycle](#)
- [Replace the Pick Up Roller](#)
- [Replace the Brake Roller](#)

Supplies

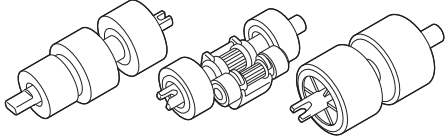
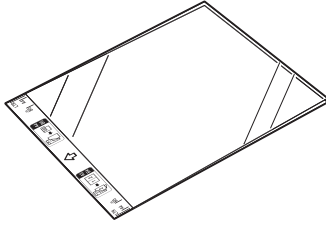
No.	Part Name	Part No.	Standard Replacement Cycle
1	Roller Kit 	PRK-A3001	100,000 sheets
2	Carrier Sheet 	CS-A3301	500 times



The Standard Replacement Cycle may vary depending on the usage environment, type of documents, and how often documents are scanned.

These parts are available through Brother retailers. If you cannot find the part you need and you have a Visa, MasterCard, Discover, or American Express credit card, you can order parts directly from Brother. Visit us online for a complete selection of the Brother parts and supplies that are available for purchase.

In USA:

1-877-552-MALL (1-877-552-6255)

1-800-947-1445 (assistance via fax)

www.brothermall.com



Related Information

- [Replace Supplies](#)

Check Supplies Replacement Cycle

- >> ADS-2200
- >> ADS-2700W

ADS-2200

- Do one of the following:
 - Windows®
Click  (Start) > All Programs > Brother > ADS-XXXXX > Remote Setup.
 - Mac
In the **Finder** menu bar, click **Go** > **Applications** > **Brother**, and then double-click the **Remote Setup** icon.
- Select your model name in the Discover Devices dialog box, and then click **Connect**.
The Remote Setup Program window appears.
- Click the **Machine Info** menu in the left navigation pane.
The window displays the remaining life of the Pick Up Roller (the example below uses Windows®).

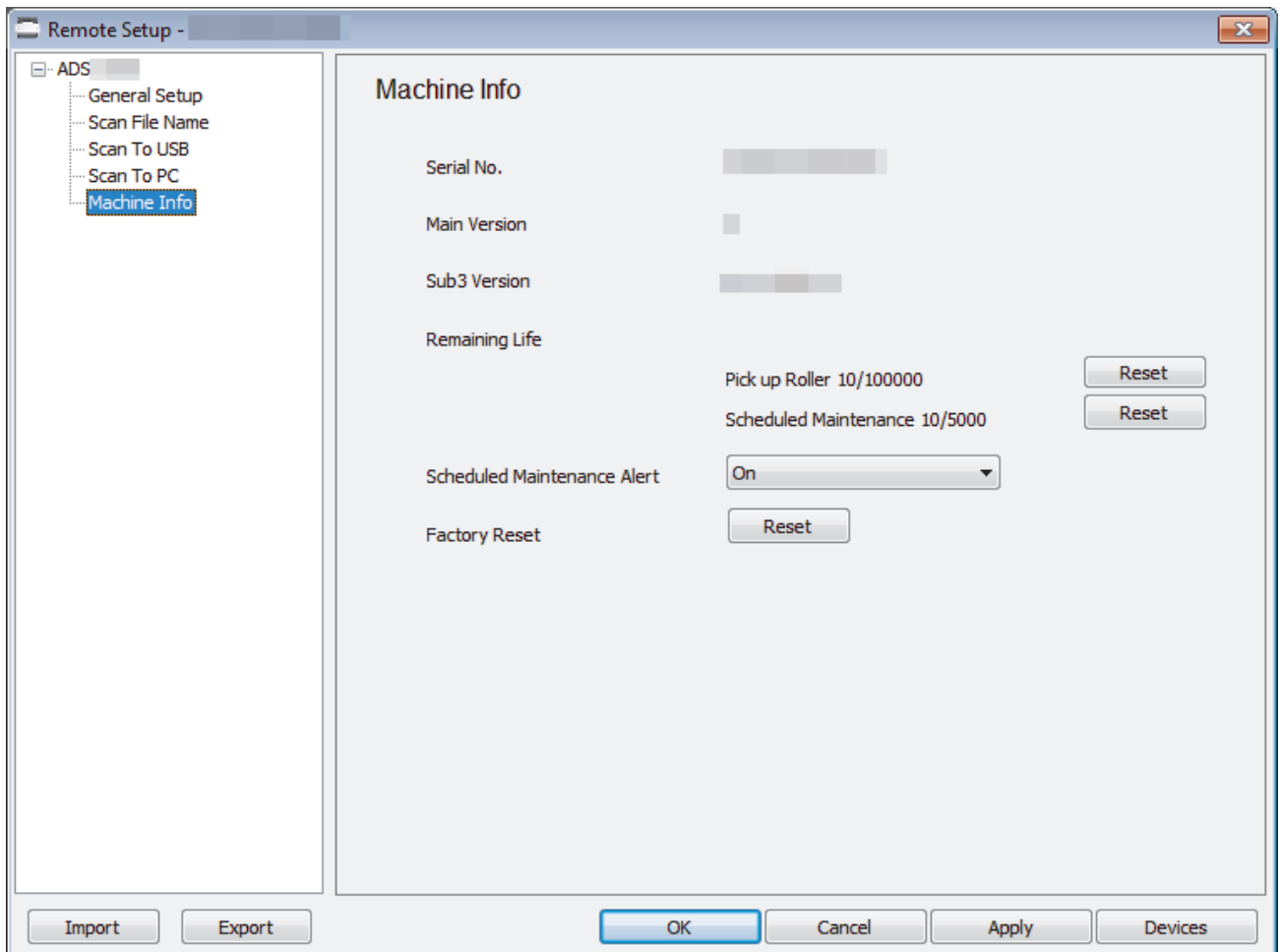

ADS-2700W

- Press  [Settings] > [Machine Info.] > [Usage Counters].
The touchscreen displays [Roller Count].



If the touchscreen indications warn you to replace the Pick Up Roller, order the necessary parts and then replace the used parts with new ones.



Related Information

- [Replace Supplies](#)
-

Replace the Pick Up Roller

Your machine is equipped with a scan counter that automatically counts how many times the machine has scanned. After approximately 100,000 scans, you may have to replace the Pick Up Roller.

1. Remove the ADF (1) .

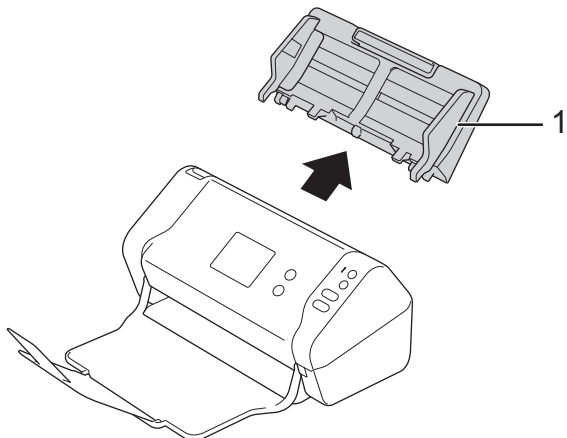

2. Press the release tab to open the Front Cover (1).

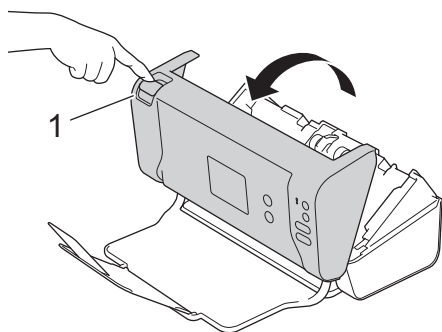

3. While pushing the right side of the Pick Up Roller Cover (1) from the front of the machine, pull the cover down.

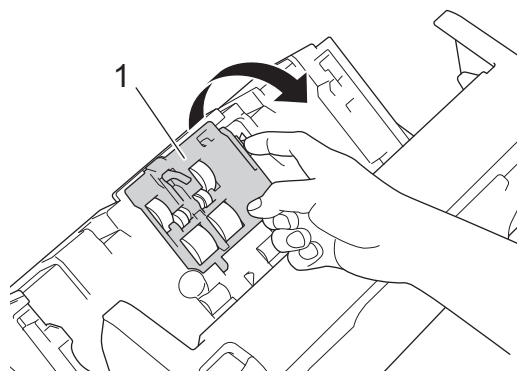

4. Slide the upper Pick Up Roller (1) to the right, and then pull it out to remove it. Remove the lower Pick Up Roller (2) in the same way.

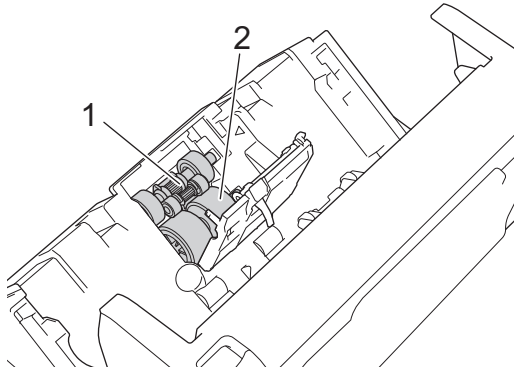

5. Fit the new lower Pick Up Roller into the opening, and then slide it to the left onto the shaft.

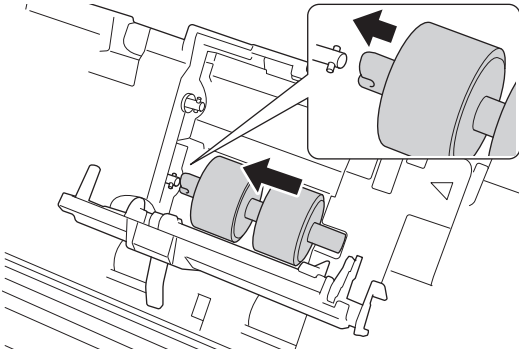

6. Fit the new upper Pick Up Roller into the opening, and then slide it to the left onto the shaft.

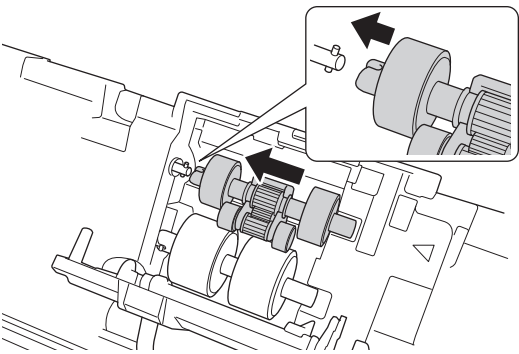

7. Close the Pick Up Roller Cover.
8. Close the Front Cover and attach the ADF.
9. Reset the Pick Up Roller Counter. See *Related Information:Reset the Usage Counters*

NOTE

Confirm the following:

- The Roller Count value is 0.
- The touchscreen or LED indications do not display a replace Pick Up Roller message.



Related Information

- [Replace Supplies](#)
- [Reset the Usage Counters](#)

Replace the Brake Roller

Your machine is equipped with a scan counter that automatically counts how many times the machine has scanned. After approximately 100,000 scans, you may have to replace the Brake Roller.

1. Press the release tab to open the Front Cover (1).

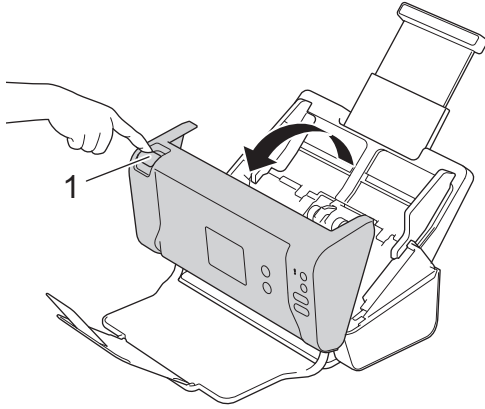

2. While pushing the left side of the Brake Roller Cover (1) from the back of the machine, pull the cover down.

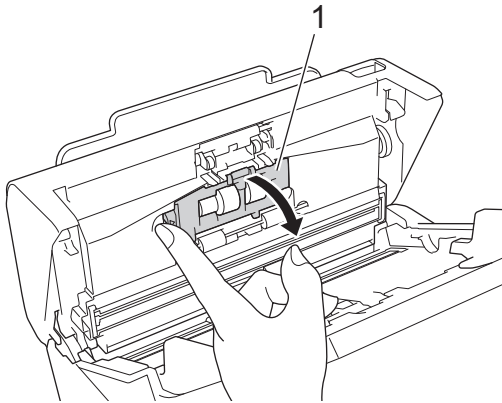

3. Lift the shaft of the Brake Roller (1) with your finger to remove the roller.

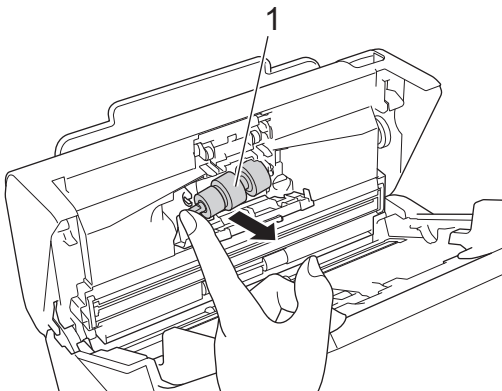

4. Fit the shaft of the new Brake Roller (1) into the slot in the opening and insert the Brake Roller into the machine.

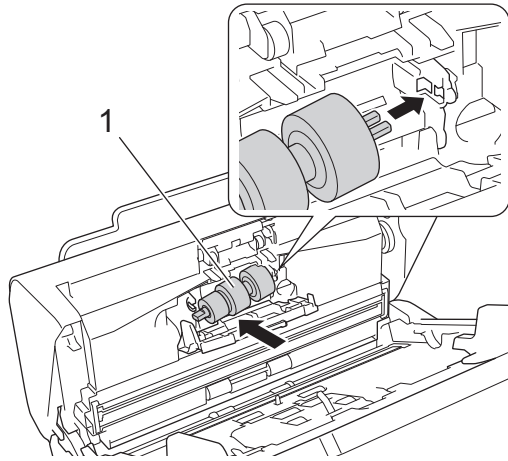

5. Close the Brake Roller Cover.
6. Close the Front Cover.

NOTE

The touchscreen or LED indications do not display either a Replace Roller or Replace Parts message.



Related Information

- [Replace Supplies](#)
- [Reset the Usage Counters](#)

Pack and Ship Your Brother Machine

When you transport the machine, use the packing materials that came with your machine. If you do not pack the machine correctly, any damage that may occur in transit may not be covered by your warranty.

The machine should be adequately insured with the carrier.

1. Close the expandable ADF.
2. Remove the ADF (1) .

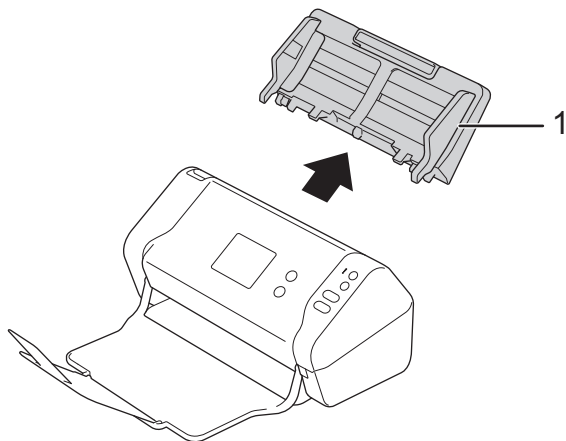

3. Close the Output Tray.

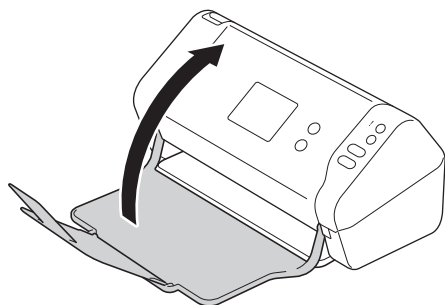

4. Wrap the machine in the original bag.

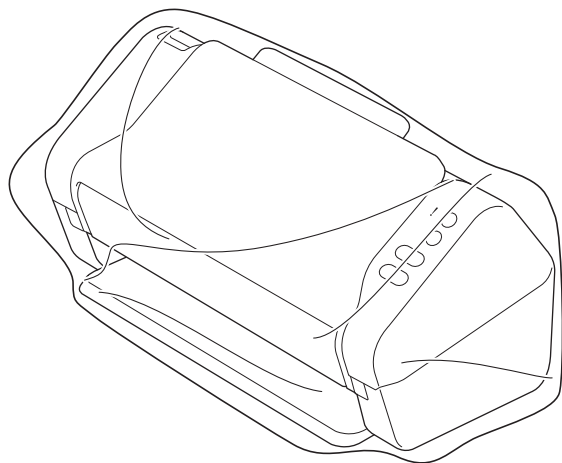

5. Pack the machine and the printed materials in the original carton with the original packing material as shown.

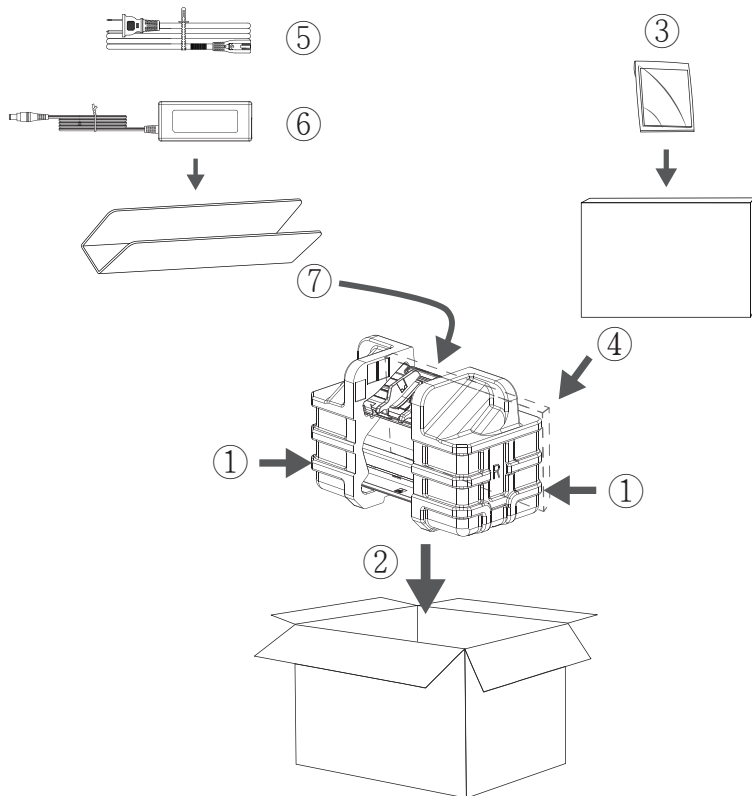

If you are returning your machine to Brother as part of the Exchange Service, pack only the machine. Keep all the separate parts (for example: power cord) and printed materials to use with your “Exchange” machine.

6. Close the carton and tape it shut.



Related Information

- [Routine Maintenance](#)

Machine Settings

- [Change Machine Settings from the Control Panel](#)
- [Change Machine Settings from Your Computer](#)

Change Machine Settings from the Control Panel

- [In the Event of Power Failure \(Memory Storage\)](#)
- [Change the General Settings from the Control Panel](#)
- [Save Your Favorite Settings as a Shortcut](#)

In the Event of Power Failure (Memory Storage)

Related Models: ADS-2700W

- Your menu settings are stored permanently and, in the event of a power failure, will not be lost.
- Temporary settings will be lost.
- During a power failure, the machine will keep the date and time for approximately 24 hours.

















Related Information

- [Change Machine Settings from the Control Panel](#)
-

Change the General Settings from the Control Panel

Related Models: ADS-2700W

Purpose	Operation	Description
Adjust the LCD Backlight Brightness	 Settings > General Setup > LCD Settings > Backlight	Adjust the brightness of the touchscreen backlight.
Change How Long the LCD Backlight Stays On	 Settings > General Setup > LCD Settings > Dim Timer	Set how long the touchscreen backlight stays on after the Home Screen appears.
Set the Home Screen	 Settings > General Setup > Screen Settings > Home Screen	Set the Home screen to either Scan 1-2 or Shortcut 1-5. When the machine is idle or you press  , the touchscreen will return to the screen you have set.
Set Sleep Mode Countdown	 Settings > General Setup > Ecology > Sleep Time	Select how long the machine must be idle before it goes into Sleep Mode. The Sleep Mode setting can reduce power consumption. When the machine is in Sleep Mode, it acts as though it is turned off. The timer will restart if any operation is carried out on the machine.  The machine will not enter Sleep Mode in the following situations: <ul style="list-style-type: none"> • A USB flash drive is inserted into the machine. • A machine error has occurred.
Set the Machine to Power Off Automatically	 Settings > General Setup > Ecology > Auto Power Off	Select how long the machine must wait before it automatically turns itself off after entering Sleep Mode. The Auto Power Off feature can save power consumption. When this feature is set to Off, you must power off the machine manually. To turn on the machine after the Auto Power Off feature has turned it Off, press  . The timer will restart if you do one of the following: <ul style="list-style-type: none"> • Press . • Press any buttons.

Purpose	Operation	Description
		 Auto Power Off will be activated when all of these conditions are met: <ul style="list-style-type: none"> • Auto Power Off setting is not set to Off. • The machine has been in Sleep Mode for more than the preset period.
Turn the Auto Start Scan Mode On	 Settings > General Setup > Auto Start Scan Mode > On	Scanning starts automatically using the settings saved as the auto scan shortcut (Shortcut 21) when you place a document in the ADF. It is not necessary to press the Scan Button. The auto scan shortcut can be registered from Shortcuts, which is used to register the regular shortcuts.
Turn the wireless network connection On	 Settings > Network > WLAN > WLAN Enable	Turn the wireless network connection On or Off.
Change the Language Displayed on the LCD	 Settings > Initial Setup > Local Language	Change your LCD language.
Change for Daylight Saving Time Automatically	 Settings > Initial Setup > Date & Time > Auto Daylight	Set the machine to change automatically for Daylight Saving Time. It will reset itself forward one hour in the spring and backward one hour in the fall. Make sure you have set the correct date and time in the Date and Time setting.



Related Information

- [Change Machine Settings from the Control Panel](#)

Save Your Favorite Settings as a Shortcut

- [Add Shortcuts](#)
- [Change or Delete Shortcuts](#)



Add Shortcuts

Related Models: ADS-2700W

Use the Shortcuts feature to create Shortcuts for frequently-used operations, such as Scan to USB, Scan to E-mail, Scan to Network and Scan to FTP/SFTP. You can recall and apply these settings as and when required. These instructions describe how to add a Scan to USB Shortcut. The steps for adding other Scan Shortcuts are very similar.



To add a shortcut for Scan to FTP/SFTP or Scan to Network, you must have added the profile name beforehand.

1. Press  ([Shortcuts]).
2. Press ◀ or ▶ to display the Shortcut screens.
3. Press  to add a new Shortcut.
4. Press ▲ or ▼ to display the [to USB] menu.
5. Press [to USB].
6. Press [Options].
7. Press ▲ or ▼ to display the available settings, and then press the setting you want to change.
8. Press ▲ or ▼ to display the available options for the setting, and then press the options you want. Repeat these steps to add additional Shortcuts. When finished, press [OK].
9. Press [Save as Shortcut].
10. Read and confirm the displayed list of settings you have selected. Press [OK].
11. Enter a name for the Shortcut. Press [OK].



You will be asked if you want to make this a One Touch Shortcut. Follow the LCD instructions.



Related Information

- [Save Your Favorite Settings as a Shortcut](#)

Change or Delete Shortcuts

Related Models: ADS-2700W

1. Press  ([Shortcuts]).
2. Press ◀ or ▶ to display the Shortcut you want to change.
3. Press and hold the Shortcut you want to change.
4. Press [Edit].



To delete the Shortcut, press [Delete]. To edit the name of the Shortcut, press [Rename] and follow the LCD.

5. Change the settings for the Shortcut you selected.
6. When finished, press [Save as Shortcut].
7. Press [OK] to confirm.



Related Information

- [Save Your Favorite Settings as a Shortcut](#)

Change Machine Settings from Your Computer

- [Change Machine Settings Using Web Based Management](#)
- [Change the Machine Settings Using Remote Setup](#)

Change Machine Settings Using Web Based Management

- [What is Web Based Management?](#)
- [Access Web Based Management](#)
- [Set a Login Password for Web Based Management](#)

What is Web Based Management?

Related Models: ADS-2700W

Web Based Management is a utility that uses a standard web browser to manage your machine using the Hyper Text Transfer Protocol (HTTP) or Hyper Text Transfer Protocol over Secure Socket Layer (HTTPS).



- We recommend Microsoft® Internet Explorer® 8/10/11 for Windows®, and Safari 8.0 for Mac. Make sure that JavaScript and Cookies are always enabled in whichever browser you use.
- You must use the TCP/IP protocol on your network and have a valid IP address registered to the scan server and your computer.

The screenshot displays the Brother Solutions Center web interface. At the top, there are navigation tabs: General, Address Book, E-mail, Scan, Administrator, and Network. The 'General' tab is selected. On the right side of the top bar, there is a 'Brother Solutions Center' logo and a 'Bottom' dropdown menu. The main content area is titled 'Status'. It features a left-hand navigation menu with the following items: Status (selected), Auto Refresh Interval, Maintenance Information, Contact & Location, Sleep Time, Auto Power Off, Panel, and Scheduled Maintenance Alert. The 'Status' section contains the following information:

- Device Status:** Ready (indicated by a green progress bar).
- Automatic Refresh:** Radio buttons for Off and On, with 'On' selected.
- Web Language:** A dropdown menu set to 'Auto'.
- Device Location:** Fields for 'Contact:' (with a person icon) and 'Location:' (with a house icon).

- Your screen may differ slightly from the screen shown.



Related Information

- [Change Machine Settings Using Web Based Management](#)

Access Web Based Management

Related Models: ADS-2700W

- We recommend using the HTTPS security protocol when configuring settings using Web Based Management.
- When you use HTTPS for Web Based Management configuration, your browser will display a warning dialog box. To avoid this warning, you can configure the certificate settings to use a valid security certificate.

1. Start your web browser.
2. Type "http://machine's IP address" in your browser's address bar (where "machine's IP address" is the machine's IP address).

For example:

http://192.168.1.2

3. By default, no password is required. If you have previously set a password, type it, and then click .

You can now change your machine settings.

IMPORTANT

If you change the protocol settings, you must restart the machine after clicking **Submit** to activate the new configuration.



Related Information

- [Change Machine Settings Using Web Based Management](#)
- [Certificates and Web Based Management](#)

Set a Login Password for Web Based Management

Related Models: ADS-2700W

We recommend setting a login password to prevent unauthorized access to Web Based Management.

1. Start your web browser.
2. Type "http://machine's IP address" in your browser's address bar (where "machine's IP address" is the machine's IP address).

For example:

http://192.168.1.2

3. By default, no password is required. If you have previously set a password, type it, and then click .
4. Click **Administrator**.
5. Type the password you want to use in the **Enter New Password** field (8 to 32 characters).
6. Retype the password in the **Confirm New Password** field.
7. Click **Submit**.

In the future, every time you access Web Based Management, type the password in the **Login** field, and then click .

8. After configuring the settings, click  to log off.



You can also set a password by clicking the **Please configure the password** button on the machine's web page (If you have not previously set a login password).



Related Information

- [Change Machine Settings Using Web Based Management](#)

Change the Machine Settings Using Remote Setup

The Remote Setup program lets you configure many of your Brother machine's settings from your computer. When you start Remote Setup, the settings on your Brother machine will be downloaded to your computer and displayed on your screen. If you change the settings on your computer, you can upload them directly to the machine.

- [Remote Setup \(Windows®\)](#)
- [Remote Setup \(Mac\)](#)

Remote Setup (Windows®)

- [Set Up the Brother Machine Using Remote Setup \(Windows®\)](#)
- [Change the General Settings Using Remote Setup](#)

Set Up the Brother Machine Using Remote Setup (Windows®)

1. Click  (Start) > All Programs > Brother > ADS-XXXXX > Remote Setup.
2. Select your model name in the Discover Devices dialog box, and then click **Connect**.
The Remote Setup Program window appears.
3. Configure the settings as needed.

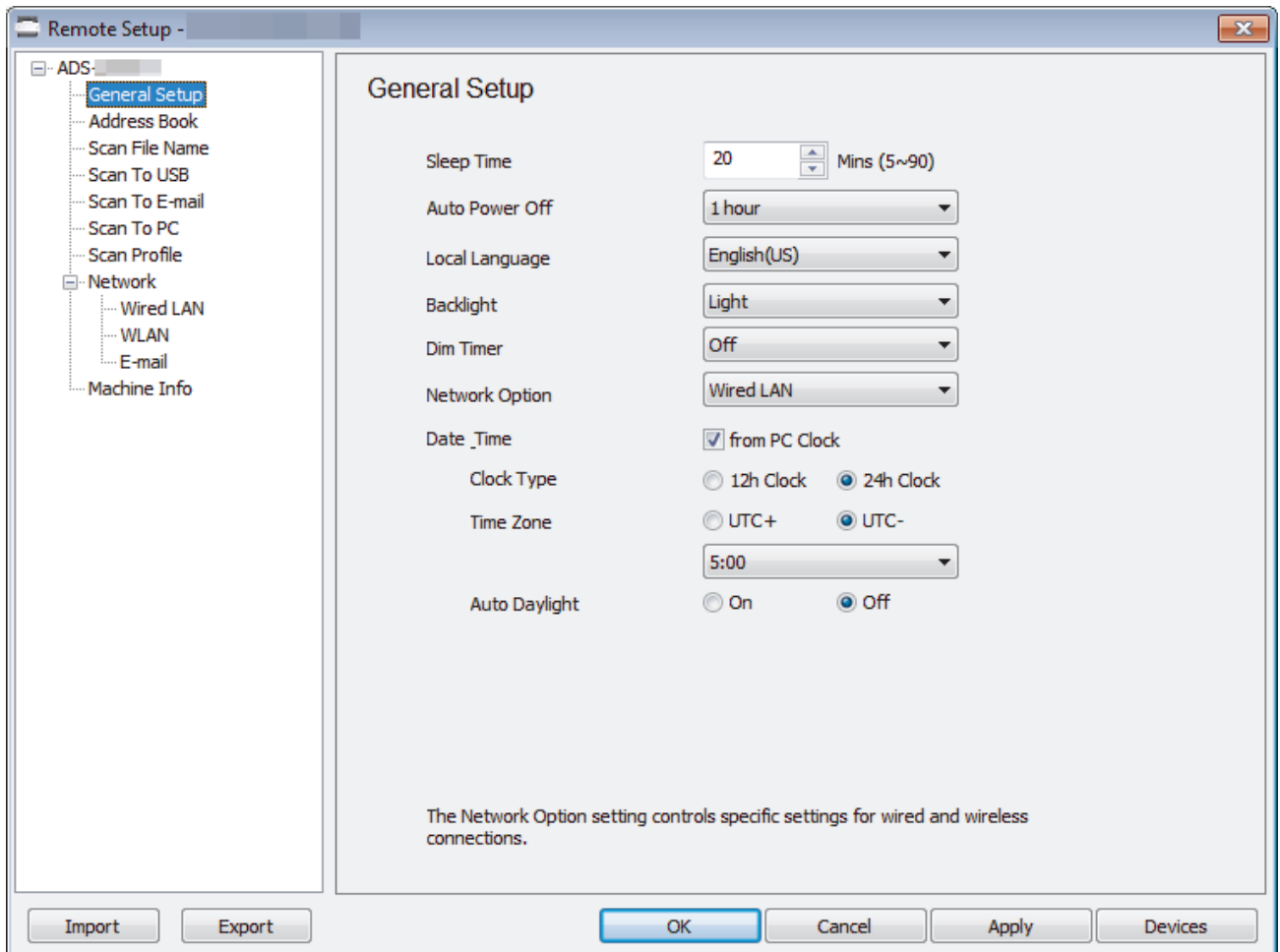

- Your screen may differ from the screen shown.

Export

Click to save the current configuration settings to a file.

Import

Click to read the settings from a file.

OK

Click to start uploading data to the machine, and then exit the Remote Setup Program. If an error message appears, confirm that your data is correct, and then click **OK**.

Cancel

Click to exit the Remote Setup Program without uploading data to the machine.

Apply

Click to upload data to the machine without exiting the Remote Setup Program.

4. Click **OK**.

-
- If your computer is protected by a firewall and is unable to use Remote Setup, you may need to configure the firewall settings to allow communication through port numbers 52515-52614.
 - If using Windows® Firewall and you installed the scanner driver, the necessary firewall settings have already been set.



Related Information

- [Remote Setup \(Windows®\)](#)
-

Change the General Settings Using Remote Setup

Purpose	Operation (Windows®/Mac)	Description
Set the Date and Time	General Setup > Date and Time	Set the date and time. If you set Auto Daylight to On, the time will be adjusted forward one hour in the spring and adjusted backward one hour in the fall.
Set Sleep Mode Countdown	General Setup > Sleep Time	Select how long the machine must be idle before it goes into Sleep Mode. The Sleep Mode setting can reduce power consumption. When the machine is in Sleep Mode, it acts as though it is turned off. <ul style="list-style-type: none">• The timer will restart if any operation is carried out on the machine.• The default setting is ten minutes.
Change the Language	General Setup > Local Language	Change your language.



Related Information

- [Remote Setup \(Windows®\)](#)
- [Remote Setup \(Mac\)](#)

Remote Setup (Mac)

- [Set Up the Brother Machine Using Remote Setup \(Mac\)](#)
- [Change the General Settings Using Remote Setup](#)

Set Up the Brother Machine Using Remote Setup (Mac)

1. In the **Finder** menu bar, click **Go > Applications > Brother**, and then double-click the **Remote Setup** icon.
2. Select your model name in the Discover Devices dialog box, and then click **Connect**.
The Remote Setup Program window appears.
3. Configure the settings as needed.

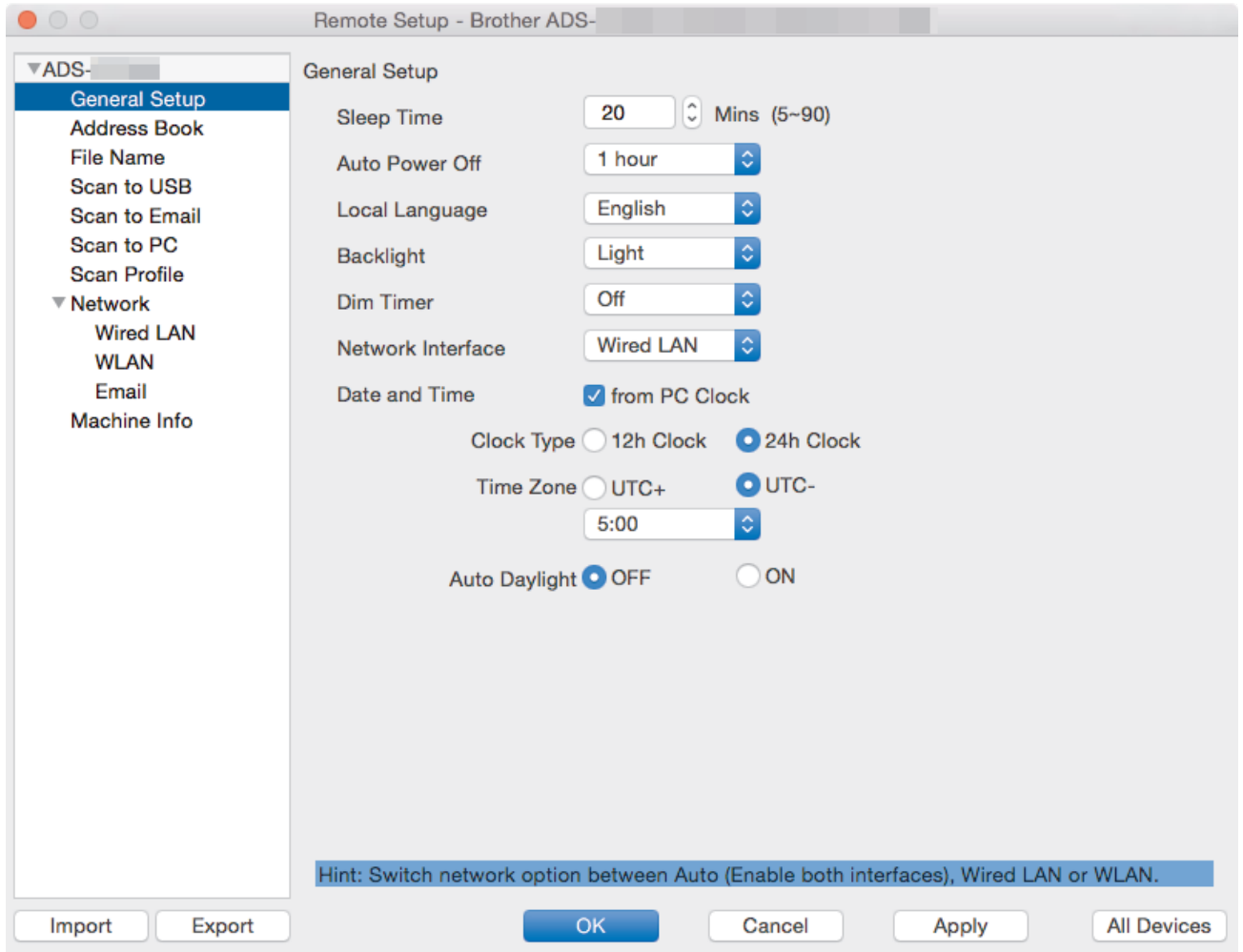

- Your screen may differ from the screen shown.

Export

Click to save the current configuration settings to a file.

Import

Click to import a file and read its settings.

OK

Click to start uploading data to the machine, and then exit the Remote Setup Program. If an error message appears, enter the correct data again, and then click **OK**.

Cancel

Click to exit the Remote Setup Program without uploading data to the machine.

Apply

Click to upload data to the machine without exiting the Remote Setup Program.

4. When finished, click **OK**.



Related Information

- [Remote Setup \(Mac\)](#)
-

Change the General Settings Using Remote Setup

Purpose	Operation (Windows®/Mac)	Description
Set the Date and Time	General Setup > Date and Time	Set the date and time. If you set Auto Daylight to On, the time will be adjusted forward one hour in the spring and adjusted backward one hour in the fall.
Set Sleep Mode Countdown	General Setup > Sleep Time	Select how long the machine must be idle before it goes into Sleep Mode. The Sleep Mode setting can reduce power consumption. When the machine is in Sleep Mode, it acts as though it is turned off. <ul style="list-style-type: none">• The timer will restart if any operation is carried out on the machine.• The default setting is ten minutes.
Change the Language	General Setup > Local Language	Change your language.



Related Information

- [Remote Setup \(Windows®\)](#)
- [Remote Setup \(Mac\)](#)

Appendix

- [Specifications](#)
- [Enter Text on Your Brother Machine](#)

Specifications

General Specifications

Memory Capacity	Standard	512 MB
Power Source		100 - 120 V AC 50/60 Hz (USA) 220 - 240 V AC 50/60 Hz (Latin American countries)
Touchscreen LCD (Liquid Crystal Display) ¹ (ADS-2700W)		Touchscreen 2.8 in. (71.1 mm) TFT Color LCD
Approx. Power Consumption ²	Scanning ³	ADS-2200: 21 W ADS-2700W: 23 W
	Ready ⁴	ADS-2200: 4.7 W ADS-2700W: 6.6 W
	Sleep	ADS-2200: 0.8 W ADS-2700W: 1.0 W
	Power Down	ADS-2200: 0.1 W ADS-2700W: 0.1 W

Dimensions

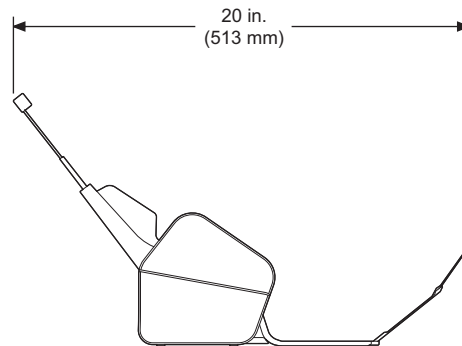
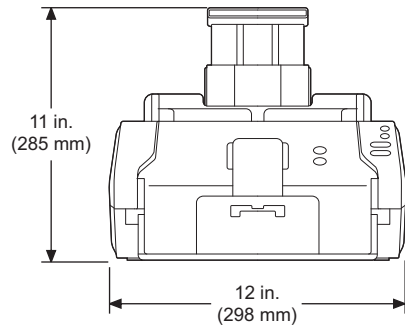
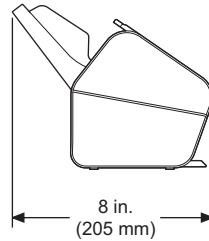
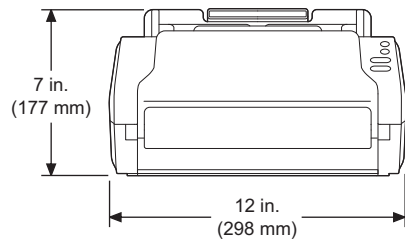

Approx. Weights

ADS-2200: 5.5 lb (2.5 kg)
ADS-2700W: 5.9 lb (2.7 kg)

Temperature

Operating	41 °F to 95 °F (5 °C to 35 °C)
Storage	32 °F to 104 °F (0 °C to 40 °C)

Humidity

Operating	20% to 80%
Storage	10% to 90%

ADF (automatic document feeder)

Up to 50 pages
(Paper: 20 lb (80 g/m²) Legal size, or less than 0.2 in. (5 mm))

- 1 Measured diagonally
- 2 Measured when the machine is connected to your computer.
- 3 When using 2-sided (duplex) scanning.
- 4 When the USB port is connected.

Document Specifications

Paper Type	Plain Paper, Thin Paper, Thick Paper, Thicker Paper, Recycled Paper, Business Card, Plastic Card	
Document Size	Width	2 in. to 8.5 in. (51 mm to 215.9 mm)
	Length	2 in. to 14.0 in. (51 mm to 355.6 mm)

Scanner Specifications

Color/Black	Yes/Yes	
TWAIN Compliant	Windows®	Windows® XP Home (SP3) / Windows® XP Professional (only 32bit SP3) / Windows® 7 (SP1) / Windows® 8 / Windows® 8.1 / Windows® 10 Windows Server® 2008 R2 / Windows Server® 2012 / Windows Server® 2012 R2 / Windows Server® 2016
	Mac	macOS v10.10.5 / 10.11.x / 10.12.x ¹
WIA Compliant	Windows®	Windows® 7 (SP1) / Windows® 8 / Windows® 8.1 / Windows® 10
ICA Compliant	Mac	macOS v10.10.x / 10.11.x / 10.12.x ¹
Color Depth	Input	48 bit color processing
	Output	24 bit color processing
Resolution	Interpolated	Up to 1200 x 1200 dpi
	Optical	Up to 600 x 600 dpi
Scanning Width	Up to 8.5 in. (215.9 mm)	
Gray Scale	256 levels	
Max. Speed	For detailed specifications visit www.brother.com .	

¹ For the latest driver updates for the version of OS X you are using, visit support.brother.com

Direct Scan Feature (Scan to USB) Specifications

Compatible Media	USB flash drive 1 ¹
Interface	Interface USB 2.0 Hi Speed

¹ USB Mass Storage standard up to 64 GB
Supported formats: FAT12/FAT16/FAT32/exFAT

Interface Specifications

USB	Hi-Speed USB 2.0 ¹ Use a USB 2.0 interface cable (Type A/B) that is no more than 6 feet (2.0 meters) long.
LAN (ADS-2700W)	Use an Ethernet UTP cable category 5 or later.
Wireless LAN (ADS-2700W)	IEEE 802.11b/g/n (Infrastructure Mode) IEEE 802.11g (Wi-Fi Direct)

¹ Your machine has a Hi-Speed USB 2.0 interface. The machine can also be connected to a computer that has a USB 1.0/1.1 interface. Third-party USB ports are not supported.

Network Specifications (ADS-2700W)

LAN	You can connect your machine to a network for Network Scanning and Remote Setup. Also included is Brother BRAdmin Light Network Management software.
Wireless Network Security	WEP 64/128 bit, WPA-PSK (TKIP/AES), WPA2-PSK (AES)
Setup Support Utility	WPS WLAN Assistant

Supported Protocols and Security Features (ADS-2700W)

Ethernet	10BASE-T, 100BASE-TX
Protocol (IPv4)	DHCP, APIPA (Auto IP), WINS/NetBIOS name resolution, DNS Resolver, mDNS, LLMNR responder, SMTP Client, FTP Client, CIFS Client, SNMPv1/v2c/v3, HTTP/HTTPS server, ICMP, Web Services (Scan), SNTTP Client
Network Security (Wired)	SMTP-AUTH, SSL/TLS (HTTPS), TLS (SMTP), SNMP v3, 802.1x (EAP-FAST, PEAP, EAP-TLS, EAP-TTLS)
Network Security (Wireless)	SMTP-AUTH, SSL/TLS (HTTPS), TLS (SMTP), SNMP v3, 802.1x (EAP-FAST, PEAP, EAP-TLS, EAP-TTLS)
Network Security (Email)	SMTP-AUTH, TLS (SMTP)
Wireless Certification	Wi-Fi Certification Mark License (WPA™/WPA2™ - Enterprise, Personal), Wi-Fi Protected Setup™ (WPS) Identifier Mark License, Wi-Fi CERTIFIED Wi-Fi Direct®

Computer Requirements Specifications

Computer Platform & Operating System Version		Supported PC Software Functions	PC Interface	Processor Minimum Speed	Hard Disk Space to Install	
					For Drivers	For Applications
Windows® Operating System ¹	Windows® XP Home SP3	Scanning	USB 10/100 BaseTX (Ethernet)	Intel® Core™ 2 Duo or equivalent	20 MB	Drivers, Installer and Software: 500MB RemoteSetup: 15MB PaperPort: 252MB BizCard: 290MB
	Windows® XP Professional (only 32bit SP3)					
	Windows® 7 (SP1)			Intel® Core™ 2 Duo or equivalent 64-bit (Intel® 64 or AMD64) supported CPU	30 MB	
	Windows® 8					
	Windows® 8.1					
	Windows® 10			Intel® Core™ i3 or equivalent 64-bit (Intel® 64 or AMD64) supported CPU	30 MB	
	Windows Server® 2008 R2					
	Windows Server® 2012					
	Windows Server® 2012 R2					
Windows Server® 2016						
Mac Operating System	macOS v10.10.5			Intel® Processor	20 MB	Drivers, Installer and Software: 150MB
	macOS v10.11.x					
	macOS v10.12.x					

						RemoteSe tup: 50MB PageMana ger: 360MB BizCard: 350MB
--	--	--	--	--	--	--

¹ PaperPort™ 14SE supports Windows® XP Home (SP3 or greater), Windows® XP Professional (SP3 or greater), Windows® 7, Windows® 8, Windows® 8.1 and Windows® 10 .



Related Information

- [Appendix](#)



Enter Text on Your Brother Machine

Related Models: ADS-2700W

When you must enter text on your Brother machine, a keyboard appears on the touchscreen.

- The characters that are available may differ depending on your country.
- The keyboard layout may differ depending on the function you are setting.



- Press  to select letters, numbers and special characters.
- Press  to select lowercase and uppercase letters.

Inserting spaces

- To enter a space, press .

Making corrections

- If you entered an incorrect character and want to change it, press , and then enter the correct character.

✓ Related Information

- [Appendix](#)

Brother International Corporation
200 Crossing Boulevard
P.O. Box 6911
Bridgewater, NJ 08807-0911 USA

brother

Visit us on the World Wide Web
www.brother.com



USA
Version A