

brother

TZ[®] **HG**[®]
TAPE TAPE

P-touch

ELECTRONIC LABELING SYSTEM

***PT-E110* User's Guide**

English

brother

TZe HGe
TAPE TAPE

P-touch

ELECTRONIC LABELING SYSTEM

PT-E110 User's Guide

English

Thank you for purchasing a Brother P-touch labeling system!

Use your new Brother P-touch labeling system to create a wide variety of custom, self-adhesive labels.

This P-touch labeling system uses Brother TZe or HGe tapes. TZe and HGe tape cassettes are available in many color and sizes. For a complete list of tapes compatible with your P-touch labeling system, visit us at: www.brother.com.

Please read this guide, and the included Product Safety Guide, before using this P-touch labeling system. After reading this guide, keep it in a safe place.

Printed in China
D00PN3001



1 GETTING STARTED

Installing Power Supply and Tape Cassette

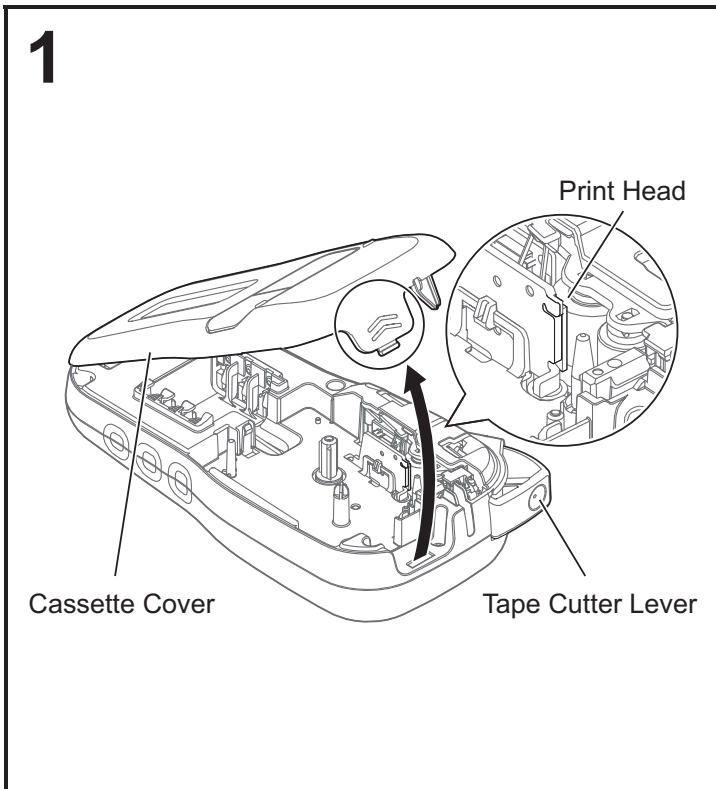

With the LCD facing down, open the Cassette Cover by pressing the grooved tab and pushing in the direction of the arrow, as illustrated.

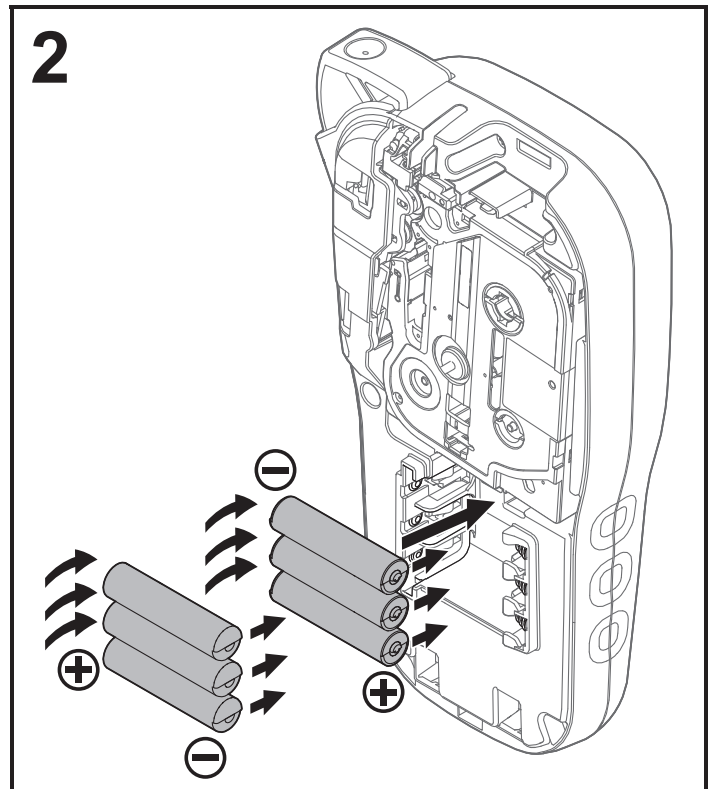

When replacing batteries or tape cassettes, make sure the power is turned off. This P-touch labeling system requires six (6) AAA alkaline batteries or six (6) fully-charged Ni-MH batteries, not included.

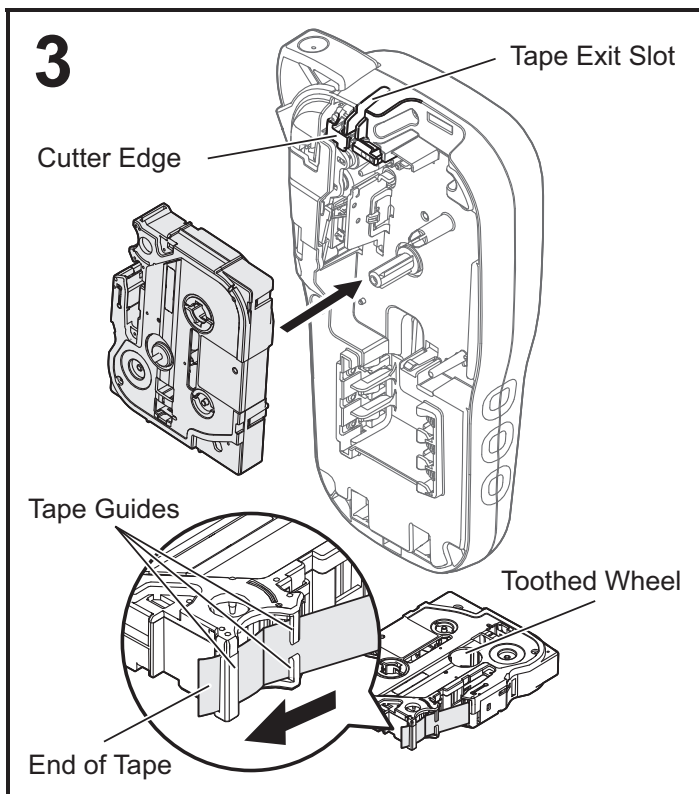

Insert the Tape Cassette following the drawing marked inside the case. Gently press the Cassette into the P-touch labeling system until it clicks into place.

- Make sure your Tape Cassette is marked **TZ** or **HGe**.
- Use only Brother TZe or HGe tapes with this machine.

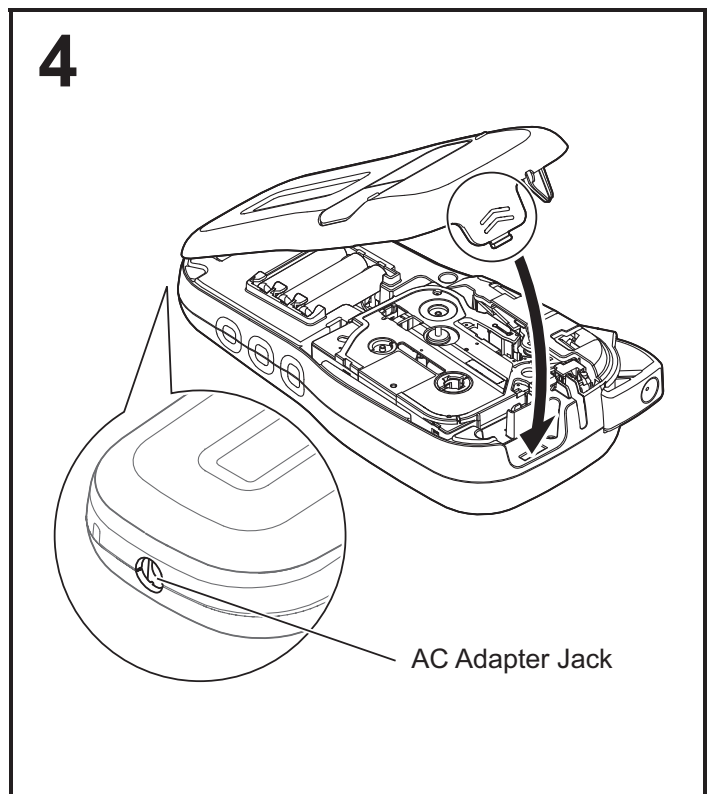

Close the Cassette Cover and gently press until it clicks into place.

NOTE

If you prefer to use the optional AC Adapter (AD24) instead of using batteries:

1. Insert the Power Adapter cord into the AC Adapter Jack on the side of the P-touch labeling system.
2. Insert the Power Adapter into a grounded AC electrical outlet.

LCD

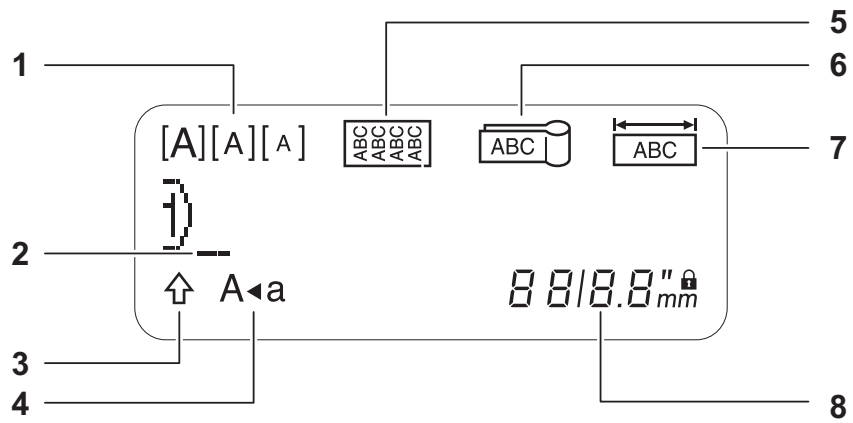

1. Size
2. Cursor
3. Shift
4. Caps

5. Cable Wrap
6. Cable Flag
7. Faceplate

8. Label Length
If a specific label length has
been selected,  also appears.

NOTE

- The LCD displays one row of 15 characters; however, the text you enter can be up to 80 characters in length.

- Label length displayed on LCD may differ slightly from the actual label length when printed.

Keyboard

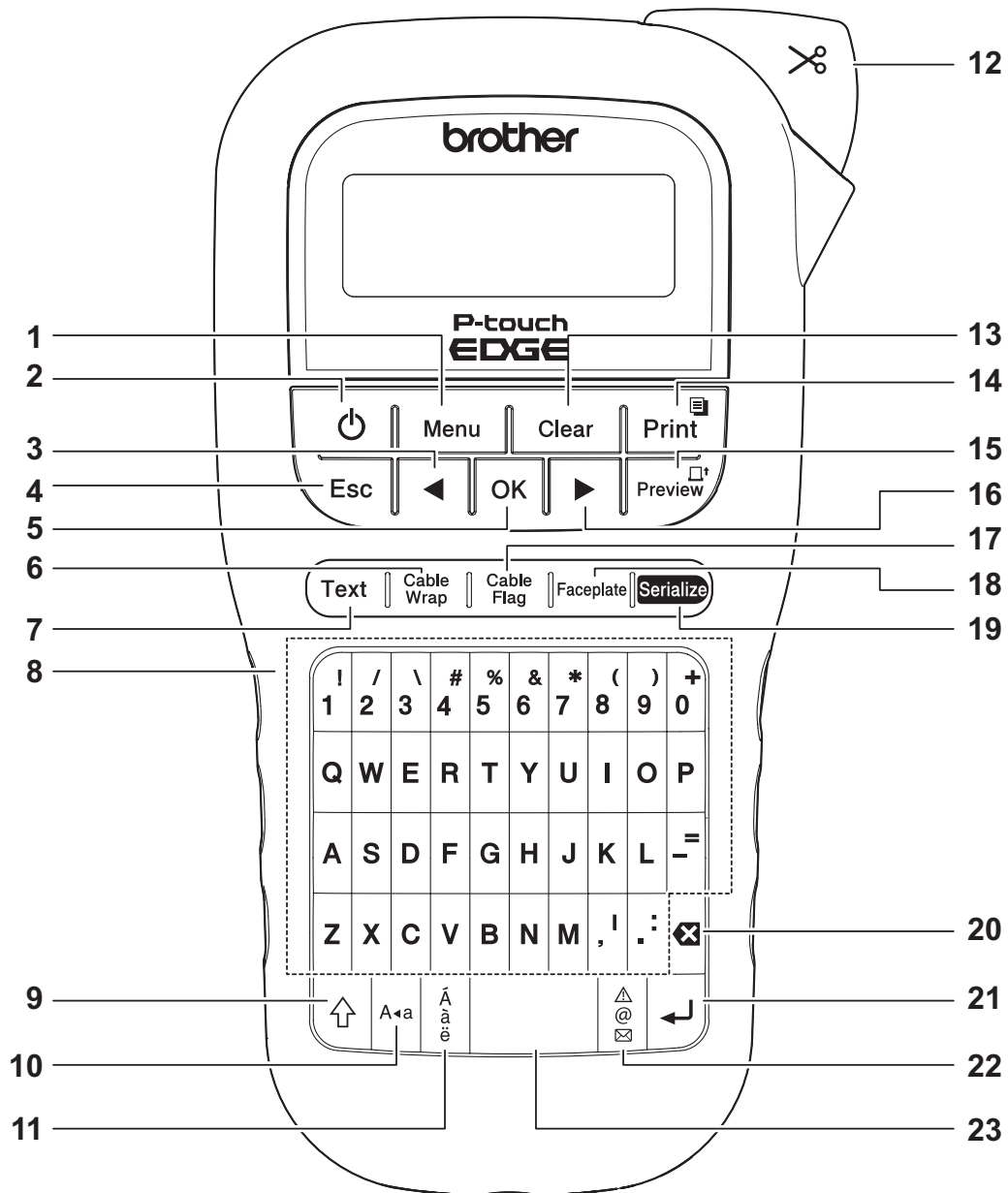

- | | | |
|---|---|--------------------|
| 1. Menu key | 9. Shift key | 17. Cable Flag key |
| 2. Power key | 10. Caps key | 18. Faceplate key |
| 3. Cursor key : Left (Use with Shift key to go to top of the text.) | 11. Accent key | 19. Serialize key |
| 4. Escape key | 12. Tape Cutter lever | 20. Backspace key |
| 5. OK key | 13. Clear key | 21. Enter key |
| 6. Cable Wrap key | 14. Print key | 22. Symbols key |
| 7. Text key | 15. Preview key | 23. Space key |
| 8. Character keys | 16. Cursor key : Right (Use with Shift key to go to end of the text.) | |

NOTE

- When selecting settings or lengths, press the Space key to return to the default value.

- Pressing the Preview key displays a generated image of the label, and may differ from the actual label when printed.

Initial Settings

1 Turn on your P-touch labeling system.

Supply power using six AAA batteries or the optional AC Adapter (AD24), and then press  to turn on the power.

2 Set the language.

The default setting is [English].

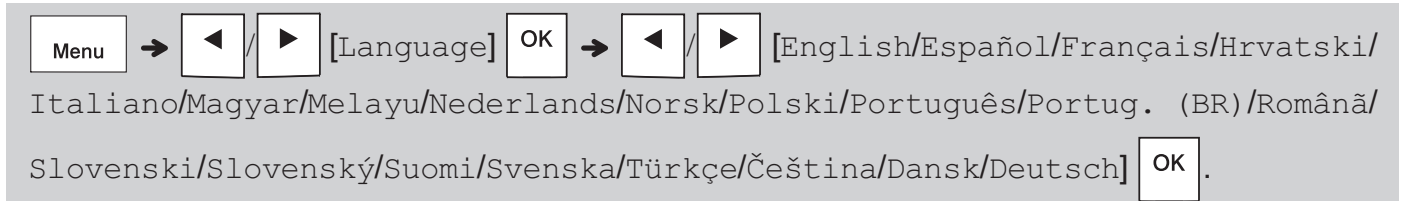

3 Set the unit of measurement.

The default setting is [inch].



NOTE

- The P-touch labeling system automatically turns off if it is inactive for five minutes.
- To cancel any operation, press .
- To return to the default setting, press the Space key.

Contrast

Use this function to set LCD brightness. There are five levels from [-2] (darkest) to [+2] (brightest). The default setting is [0].



NOTE

- To return to the default setting, press the Space key.

Supplies and Accessories

Cassettes: See the included *Supplies and Accessories Guide*.

AC Adapter: AD24

Cutter Unit: TC-4 (replacement)

If the cutter blade becomes blunt after repetitive use and the tape cannot be cut cleanly, turn the cutter board as shown in the illustration ①.

If you still have difficulties, replace with new cutter unit (stock no. TC-4) from an authorized Brother reseller.

► Replacing the Cutter Unit

1. Remove the two sections of the Cutter Unit (green) in the direction of the arrows as illustrated below ②.
2. Install a new Cutter Unit. Push it in gently until it snaps into place.

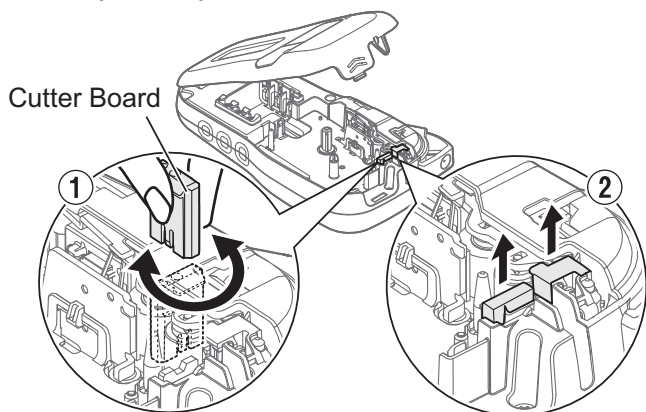

⚠ WARNING

Do not touch the cutter blade directly with your fingers.

Specifications

Dimensions: 4.3" X 8.0" X 2.2"
(W x D x H) (Approx. 109(W) X 202(D) X 55(H)mm)

Weight: Approx. 0.9 lb. (Approx. 400 g)
(without batteries and tape cassette)

Power supply: Six AAA alkaline batteries (LR03)
Six AAA Ni-MH batteries (HR03)*¹
Optional AC Adapter (AD24)

Tape cassette: Brother P-touch TZe tape widths:
0.13" (3.5mm), 0.23" (6mm),
0.35" (9mm), 0.47" (12mm)
Brother HGe tape widths:
0.23" (6mm), 0.35" (9mm),
0.47" (12mm)

*1 Visit support.brother.com for the latest information about the recommended batteries.

2 BASIC USAGE

Entering Text

You can enter a maximum of 80 characters and spaces for a text label.

To cancel any operation, press .

► Switching Upper Case / Lower Case



Upper case

( ON)

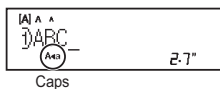

Lower case

( OFF)

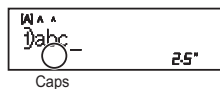

► Creating Two-Line Tapes

Move the cursor to where you want to start the next line and press . Use either 0.35" (9mm) or 0.47" (12mm) tape for two-line printing.

Line 1

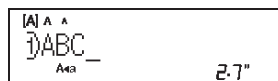



The image

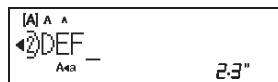

Line 2



● NOTE

- The return symbol () appears when you press the Enter key .

► Entering Tabs



- The tab symbol  appears when you insert a tab in the text.

► Changing Tab Length

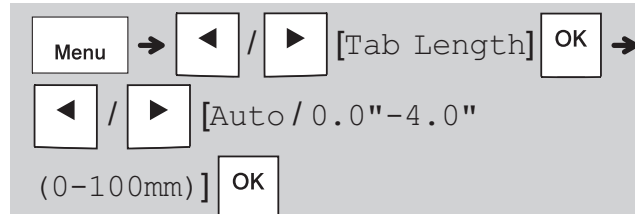

- To return to the default tab length, press the Space key.
- Please note: the default length varies based on your tape size.

► Cursor Keys

To move to the end of your text:



To move to the beginning of your text:



► Entering Accented Characters



- Refer to the **Accented Characters** table in this guide.
- The order of accented characters varies based on the language you selected.

► Changing Label Length

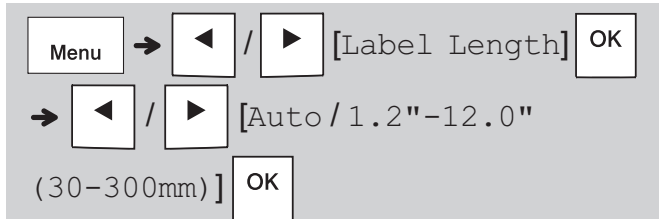

NOTE

- The lock symbol  appears when you set a specific tape length.
- To return to the default length (Automatic, based on text length), press the Space key.

► Clearing Text and Settings

To delete individual letters and spaces, press .

To delete all text :



To delete all text and settings:





Saving Tapes Files

You can save and reuse the text and settings for up to nine different labels. Each tape holds up to 80 characters (including spaces). Assign a number (1-9) to each saved file so you can reuse it, and edit or overwrite stored files as needed.

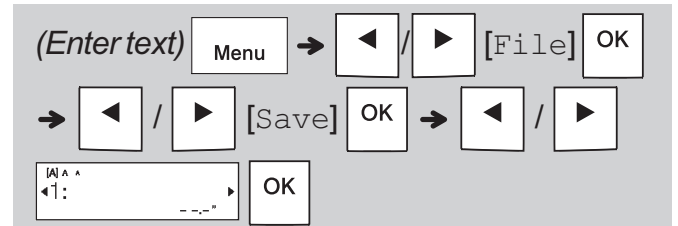
► Saving a new file



NOTE

- When saving a file, if you reuse a number that is already assigned to another file, [Overwrite OK?] appears on the LCD. To overwrite the previously-saved file, press . To cancel without saving, press .

► Printing a saved file

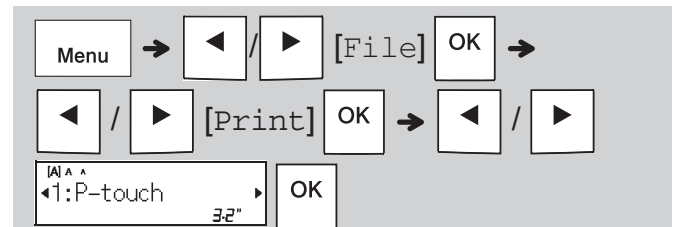

► Opening a saved file

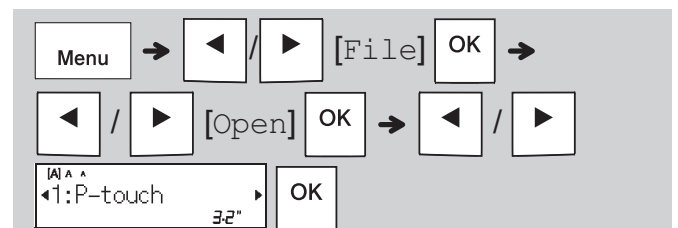

Text Key Text

- 1 Press Text to select the settings to enter the text.



- 2 Press ◀ / ▶ to select the settings.

Size	Large	<u>A</u>
	Medium	<u>A</u>
	Small	<u>A</u>
Style	Normal	A
	Bold	A
	Outline	<u>A</u>
	Shadow	<u>A</u>
	Italic	<i>A</i>
	I+Bold	<i>A</i>
	I+Outline	<u><i>A</i></u>
	I+Shadow	<u><i>A</i></u>
	Vertical	⊥
	V+Bold	⊥
	Width	Normal
× 2		A
× 1/2		<u>A</u>

Underline and Frame

Emphasize text using underlines or a frame.

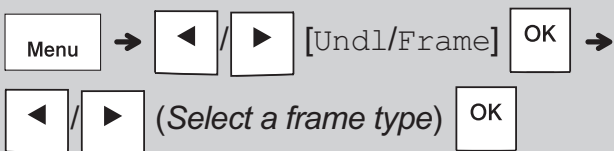

2
12345 ← → ↶ ↷
3

Symbols Key

▶ Entering Symbols

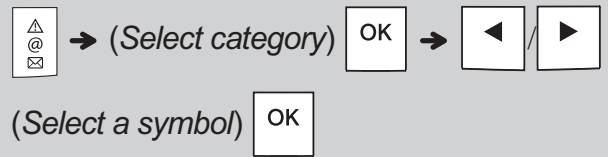





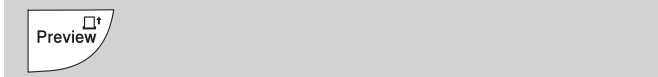

- Refer to the **Symbols** table in this guide.
- To cancel operation, press Esc.
- Select History to view up to seven recently-used symbols.
- You can also insert Symbols by pressing the shortcut keys, as shown below.

Punctuation	Space key	Currency	G
History	A	Greek	H
Brackets	B	Electrical	I
Bullets	C	Datacom	J
Super/ Subscript	D	AV/Security	K
Mathematics	E	Safety	L
Arrows	F		

Printing Labels

► Preview



- Pressing the Preview key displays a preview of the label, and may differ from the actual one when printed.
- If the LCD cannot display all the text at once, press  /  to display the hidden text.
- Press  /  /  to exit Preview mode.

► Feeding (Tape Feed)



- This function feeds approximately 1" (25mm) of blank tape.
- Do not pull uncut tape from the Tape Cassette as this may damage the Tape Cassette.

► Printing



Press the Print key to print the text displayed on the LCD.

► Printing Multiple Copies



- You can print up to nine copies of each label.
- DO NOT touch the Tape Cutter Lever while the message [Please Wait] appears on the LCD.
- **To cut tape:** When printing ends, push the Tape Cutter Lever after the message [Please Cut] appears.
- To remove tape backing, fold the tape lengthwise (with the text facing inward), to expose the inside edges that run down the center of the tape backing. Peel and apply.

► Setting Margins

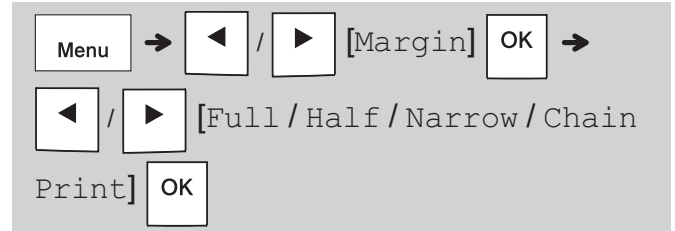

[Full] / [Half] / [Narrow]



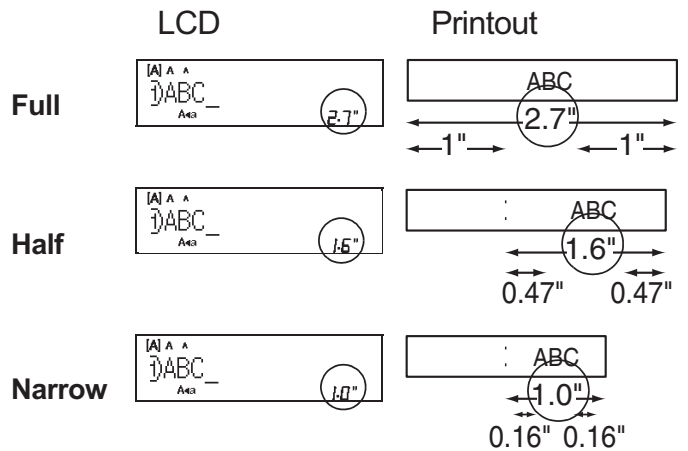

Use one of these options to customize margin length before and after your text.

The printed dots (:) indicate the end of the label. Cut along the printed dots (:) with scissors.





[Chain Print] (tape-saving option)

Use this option to print multiple different labels with narrow margins. This option saves tape.

1. Enter your text.
2. Press .
3. When [Feed OK?] appears on the LCD, press  to change the text.
4. Clear the text, enter the text you want on the next label, and then press .
5. After your last label prints, when [Feed OK?] appears on the LCD, press .

● NOTE

- When you use [Chain Print], feed the tape before using the cutter ( + ) , otherwise part of the text may be cut off.
- Do not pull the tape, as this may damage the Tape Cassette.
- The printed dots (:) indicate the end of the label. Cut along the printed dots (:) with scissors.

3 LABEL APPLICATION KEYS

Cable Wrap

Use this function to create a label that can be wrapped around a cable or wire.

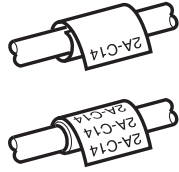

Turn on the Cable Rotate/Repeat function to print text repeatedly along the length of the label so that it can easily be read from any angle.

- To activate the Text Repeat function, press

and then select .

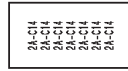

→ / (Select a cable diameter)
 → (Input text) →

- Cable diameter: 0.2" to 3.6" (3mm to 90mm) available
Default: 0.3" (6mm)

Cable Flag

Use this function to create a label that can be wrapped around a cable or wire with its ends applied together to form a flag.

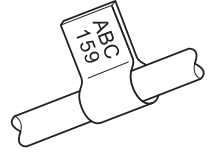

You can select the desired flag length. When you select



→ / (Select a flag length)
→ (Input text) →

- Flag length: 0.4" to 8.0" (10mm to 200mm), Auto
Default: Auto
- Use the Cable Flag function when the diameter of the object is more than 0.2" (3mm).
- Text cannot be rotated when using the Cable Flag function.

NOTE

- We recommend using Flexible ID Tape for labels attached to cables and wires.
- To cancel the Cable Wrap/Cable Flag/Faceplate functions during operation, press / or accordingly.
- Depending on the format you select, the entire contents of your text may not be printed. For example, if the text is too long to fit into the format, the

Faceplate

Use this function to create a label that can be used to identify various components, or panels. Using the Faceplate function ensures that each block of text is evenly spaced on a single label.

18A 20J 34C 40B

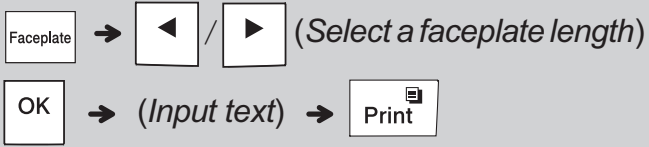

- Faceplate length: 1.2" to 12.0" (30mm to 300mm)
Default: 2.0" (50mm)

Serialize

Use this function to create multiple labels with a number or letter automatically incremented on each label.

This serializing function can also be used with the Cable Wrap, Cable Flag, or Faceplate templates to save time entering and printing a series of labels.

18A 18B 18C 18D

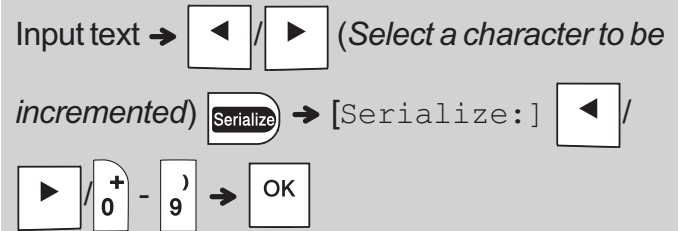

- You can Serialize numbers from 01 - 50.



4 HELPFUL HINTS

Shortcuts

Language	Menu → Space key
Undl/Frame	Menu → ! 1
Label Length	Menu → / 2
Margin	Menu → \ 3
CableRot/Rpt	Menu → # 4
File	Menu → % 5
Tab	Menu → & 6
Tab Length	Menu → * 7
Unit	Menu → (8
LCD contrast	Menu →) 9

Resetting the P-touch Labeling System

Reset your P-touch labeling system when you want to initialize the settings, or in the event it is not working properly. Resetting clears all the text, settings, and stored files.

1 Turn off the P-touch labeling system, hold down  and **R**, and then press  to turn the P-touch labeling system back on.

2 First release the power button, and then release  and **R**.

The P-touch labeling system turns on with the internal memory reset.

If you have questions or need information about your Brother product, please visit us online or call.

For FAQs, Troubleshooting, and Manuals, visit support.brother.com.

To order supplies and accessories, visit www.brothermall.com or call 1-877-552-6255.

For USA Customer Service, call 1-877-BROTHER (1-877-276-8437)
Fax: 1-901-379-1210

⚠ CAUTION

USING A COMBINATION OF DIFFERENT BATTERIES (SUCH AS ALKALINE WITH Ni-MH), MAY RESULT IN AN EXPLOSION. DISPOSE OF USED BATTERIES ACCORDING TO THE INSTRUCTIONS.

● NOTE

- Remove the batteries if you do not intend to use the P-touch labeling system for an extended period of time.
- Dispose of batteries at an appropriate collection point, not in the general waste stream. Be sure to observe all applicable federal, state, and local regulations.
- When storing or discarding a battery, wrap it with cellophane tape to prevent it from short-circuiting. (see illustration)



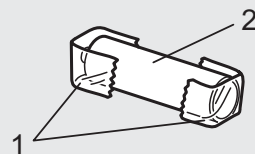





1. Cellophane tape
2. Alkaline or Ni-MH battery





Do not mix old and new batteries. Replace all six batteries at the same time.

Troubleshooting

► Error messages

Message	Cause / Remedy
Battery Low!	The batteries are weak. If using AAA alkaline batteries, replace them with new ones (do not use a combination of old and new batteries). If using Ni-MH batteries, charge them fully.
Battery Empty!	The installed batteries are exhausted and need to be replaced for continued operation.
Invalid!	<ul style="list-style-type: none"> • An invalid number was entered as the label length, tab length, cable diameter, flag length or faceplate length. • An invalid letter or number to be incremented was selected in the Serialize function.
No Text!	<ul style="list-style-type: none"> • You tried to print a text file when there is no data stored in the memory. •  is pressed when no text is entered. •  +  is pressed when no text is entered. •  is pressed when no text is entered. •  or  was pressed when no text was entered while using templates.
2 Line Limit! / 1 Line Limit!	<ul style="list-style-type: none"> • You tried to enter a 3rd line by pressing . • You tried to print or preview two lines of text while 0.13" (3.5mm) or 0.23" (6mm) tape is installed. Install a larger tape size.
No Cassette!	There is no cassette installed. Install a cassette with the  mark or  mark.

Message	Cause / Remedy
Cutter Pressed	The Tape Cutter Lever was pressed in the middle of the printing process.
Text Full!	The maximum number of characters (80 characters for text) have already been entered.
Text Limit! Change Length	You may have exceeded the set tape length. Reduce the text or select [Auto] as the tape length.
Feed OK?	<ul style="list-style-type: none"> • Feeding tape after printing when [Chain Print] is selected. Refer to the Setting Margins section in this guide.
Wrong Tape! Use TZe tape	<ul style="list-style-type: none"> • Use a cassette with the  mark or  mark.

► **What to do when**

Problem	Solution
The display remains blank after you have turned on the P-touch labeling system.	<ul style="list-style-type: none"> • Check that the batteries are correctly installed. Refer to the <i>Installing Power Supply and Tape Cassette</i> section. • The batteries may be weak. Replace them. • Check that the AD24 Adapter is correctly connected.
When the label is printed, there is too much margin (space) on both sides of the text.	<ul style="list-style-type: none"> • Refer to the <i>Setting Margins</i> section in this guide and select [Half], [Narrow] or [Chain Print] to have smaller margins for your tape.
The P-touch labeling system does not print, or the printed characters are not formed properly.	<ul style="list-style-type: none"> • Check that the cassette is inserted correctly. • If the cassette is empty, replace it. • Check that the Tape Cassette Cover is closed correctly.
The setting has cleared on its own.	<ul style="list-style-type: none"> • The batteries may be weak. Replace them. • When power is disconnected for more than three minutes, all text and formats in the display settings are cleared.
A blank horizontal line appears through the printed tape.	<ul style="list-style-type: none"> • There may be some dust on the Print Head. Remove the cassette and use a dry cotton swab to gently wipe the Print Head with an up-and-down motion. Refer to the <i>Installing Power Supply and Tape Cassette</i> section in this guide for the Print Head location.

Problem	Solution
The P-touch labeling system has “locked up” (i.e., nothing happens when a key is pressed, even though the P-touch labeling system is on.)	<ul style="list-style-type: none"> • Refer to the <i>Resetting the P-touch Labeling System</i> section in this guide.
The power turns off when you try to print.	<ul style="list-style-type: none"> • The batteries may be weak. Replace them. • Check that the batteries are correctly inserted. • The wrong AC Adapter is used. We recommend using the AD24 Adapter.
The tape does not feed properly or the tape gets stuck inside the P-touch labeling system.	<ul style="list-style-type: none"> • Check that the end of the tape feeds under the tape guides. Refer to the <i>Installing Power Supply and Tape Cassette</i> section in this guide for an example. • The Cutter Lever is pressed while printing. Do not touch the Cutter Lever during printing.
To change language setting.	<ul style="list-style-type: none"> • Refer to the <i>Initial Settings</i> section in this guide.